



60×60×20 mm

San Ace 60 9GA type Low Power Consumption Fan

General Specifications

- Material Frame: Plastic (Flammability: UL 94V-0), Impeller: Plastic (Flammability: UL 94V-0)
- Expected life See the table below. (L10 life: 90% survival rate for continuous operation in free air at 60°C, rated voltage)
- Motor protection function Locked rotor burnout protection, Reverse polarity protection
For details, please refer to p. 547.
- Dielectric strength 50/60 Hz, 500 VAC, for 1 minute (between lead wire conductors and frame)
- Insulation resistance 10 MΩ or more with a 500 VDC megger (between lead wire conductors and frame)
- Sound pressure level (SPL) At 1 m away from the air inlet
- Storage temperature -30 to +70°C (Non-condensing)
- Lead wire ⊕Red ⊖Black (Sensor) Yellow (Control) Brown
(For models without PWM control function, there is no speed control wiring.)
- Mass 70 g

Specifications

The models listed below **have ribs and pulse sensors with PWM control function.**

Model no.	Rated voltage [V]	Operating voltage range [V]	PWM duty cycle* [%]	Rated current [A]	Rated input [W]	Rated speed [min ⁻¹]	Max. airflow [m ³ /min] [CFM]	Max. static pressure [Pa] [inchH ₂ O]	SPL [dB (A)]	Operating temperature [°C]	Expected life [h]
9GA0612P6G001	12	10.8 to 13.2	100	0.26	3.12	6850	0.88 31.1	125 0.5	43	-20 to +70	40000/60°C (70000/40°C)
9GA0612P6S001			100	0.15	1.8	5500	0.7 24.7	81 0.33	36		
9GA0624P6G001	24	21.6 to 26.4	100	0.12	2.88	6850	0.88 31.1	125 0.5	43		
9GA0624P6S001			100	0.07	1.68	5500	0.7 24.7	81 0.33	36		

* PWM frequency: 25 kHz. Fan does not rotate when PWM duty cycle is 0%.

The following sensor and control options are available for selection.

Available for all models. **Without sensor**

Differs according to the model. Refer to the table on p. 571. **Pulse sensor**

The models listed below **have ribs and pulse sensors.**

Model no.	Rated voltage [V]	Operating voltage range [V]	Rated current [A]	Rated input [W]	Rated speed [min ⁻¹]	Max. airflow [m ³ /min] [CFM]	Max. static pressure [Pa] [inchH ₂ O]	SPL [dB (A)]	Operating temperature [°C]	Expected life [h]
9GA0612H6001	12	10.8 to 13.2	0.09	1.08	4100	0.52 18.4	45 0.18	29	-20 to +70	60000/60°C
9GA0612M6001			0.05	0.6	2700	0.34 12.0	20 0.08	18		
9GA0624H6001	24	21.6 to 26.4	0.04	0.96	4100	0.52 18.4	45 0.18	29		
9GA0624M6001			0.03	0.72	2700	0.34 12.0	20 0.08	18		

The following sensor and control options are available for selection.

Available for all models. **Without sensor** **Lock sensor**

Airflow - Static Pressure Characteristics / PWM Duty - Speed Characteristics Example

9GA0612P6G001 With pulse sensor with PWM control function

PWM duty cycle

Operating voltage range

PWM duty - Speed characteristics example

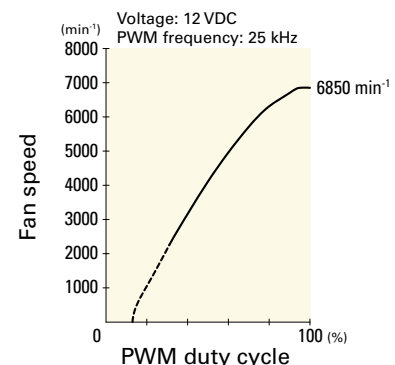
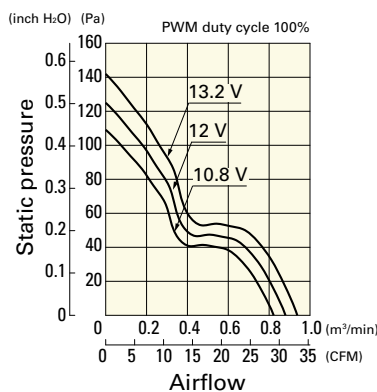
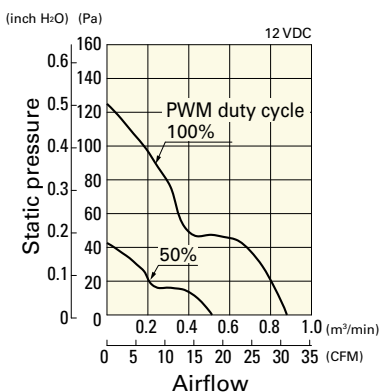

Airflow - Static Pressure Characteristics / PWM Duty - Speed Characteristics Example

9GA0612P6S001 With pulse sensor with PWM control function

PWM duty cycle

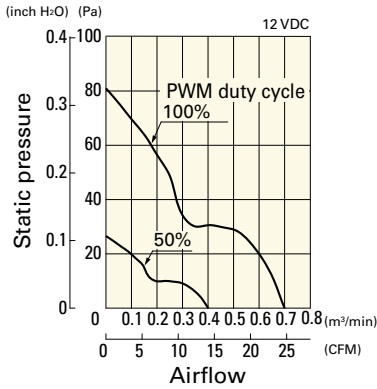

Operating voltage range

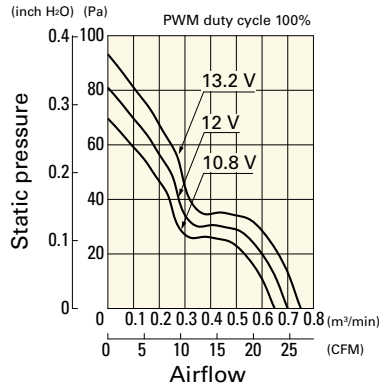

PWM duty - Speed characteristics example

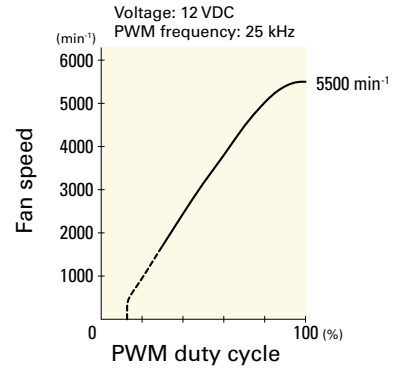

9GA0624P6G001 With pulse sensor with PWM control function

PWM duty cycle

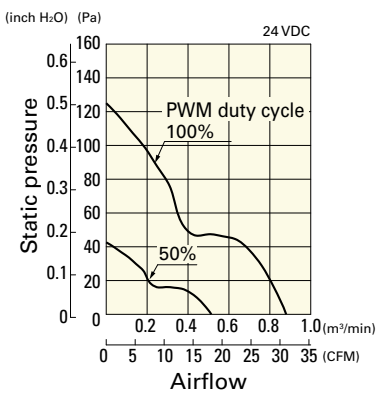

Operating voltage range

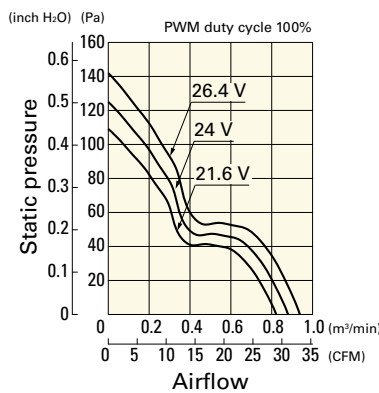

PWM duty - Speed characteristics example

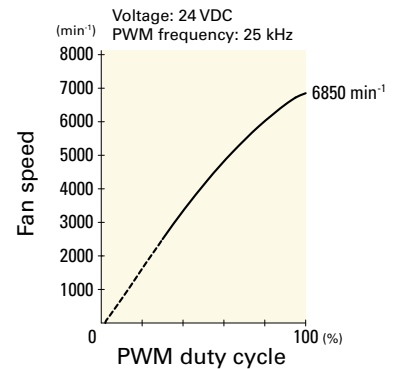

9GA0624P6S001 With pulse sensor with PWM control function

PWM duty cycle

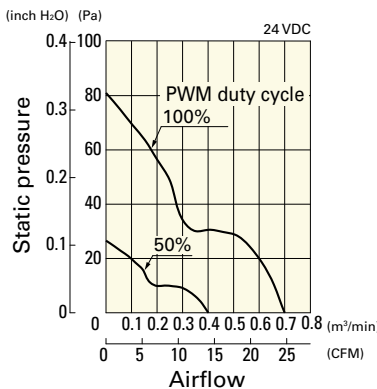

Operating voltage range

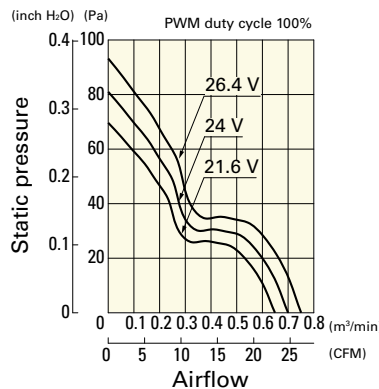

PWM duty - Speed characteristics example

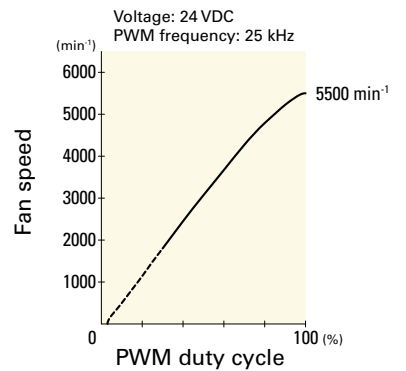

9GA0612H6001 With pulse sensor

Operating voltage range

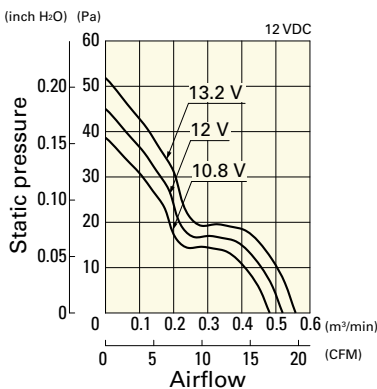

9GA0612M6001 With pulse sensor

Operating voltage range

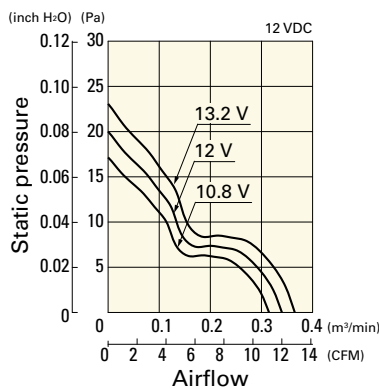

9GA0624H6001 With pulse sensor

Operating voltage range

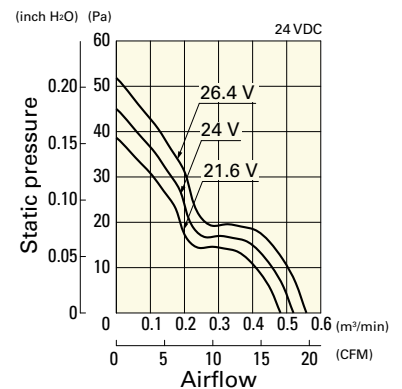

Airflow - Static Pressure Characteristics

9GA0624M6001 With pulse sensor

Operating voltage range

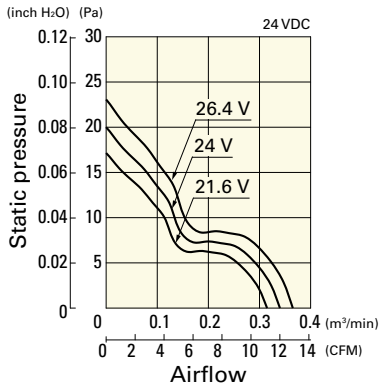

Dimensions (unit: mm) (With pulse sensor with PWM control function)

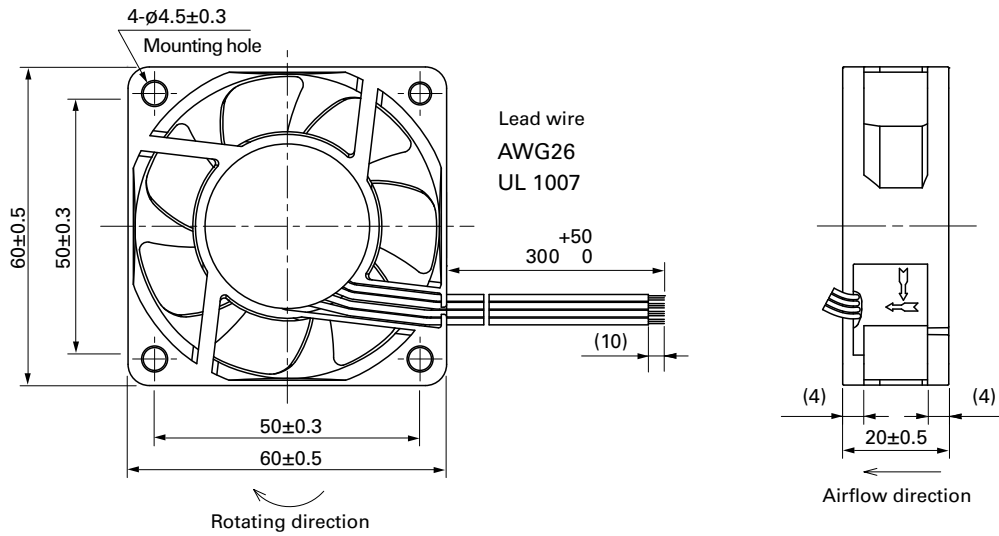

Reference Dimensions of Mounting Holes and Vent Opening (unit: mm)

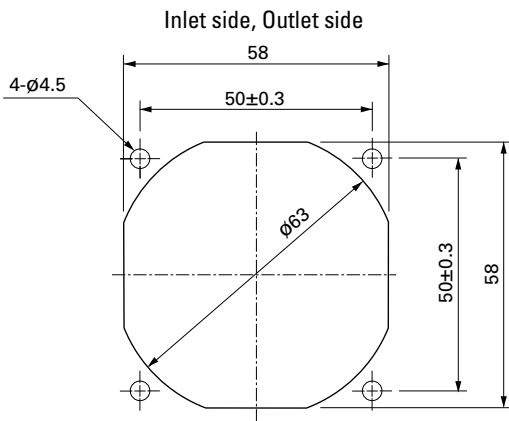

Options

Finger guards page: p. 532

Model no.: 109-139E, 109-139H

Resin finger guards page: p. 539

Model no.: 109-1003G

Resin filter kits page: p. 540

Model no.: 109-1003F13 (13PPI), 109-1003F20 (20PPI),
109-1003F30 (30PPI), 109-1003F40 (40PPI)