



User Manual
Gateway Component for PROFINET

Table of Contents

1	General Information	3
1.1	Disclaimer	3
1.2	Notes Regarding this User Manual.....	3
1.3	Validity	4
1.4	Limitation of Liability	4
1.5	Customer Service	4
2	Safe Use	5
2.1	Intended Use	5
2.2	User	5
2.3	Symbols.....	5
2.4	Important safety instructions.....	6
2.5	Environmental Conditions.....	7
2.6	Data safety	7
3	Overview	8
3.1	Functionality	8
3.2	Control Elements.....	9
3.3	Status LEDs.....	12
4	Installation	13
4.1	Preparations for Inteference-free Operation.....	13
4.2	Requirements	15
4.3	Connecting Gateway Components.....	16
4.4	Installing a Gateway in the Control Cabinet	17
4.5	Connecting a Power Supply	18
4.6	Connecting a Gateway to the Fieldbus.....	19
5	Configuration.....	20
5.1	Supported size of process data	20
5.2	Setting Station Name.....	20
5.3	Exchanging Data cyclically	21
5.4	Exchanging Data acyclically (Records)	25
5.4.1	I&M Data.....	27
5.4.2	Diagnosis Alarm.....	28
6	Integrated servers	29
6.1	FTP-Server	29
6.2	Webserver	29
6.3	Firmware Update	31
7	Technical Data.....	42
7.1	Technical Data.....	42

1 General Information

1.1 Disclaimer

© 2019 KUNBUS GmbH, Denkendorf (Deutschland)

The contents of this user manual have been compiled by KUNBUS GmbH with the greatest possible care. Due to technical developments, KUNBUS GmbH reserves the right to change or exchange the contents of this user manual without prior notice. You can always obtain the latest version of the user manual from our homepage: www.kunbus.com

KUNBUS GmbH shall be liable exclusively to the extent specified in the General Terms and Conditions (www.kunbus.de/agb.html).

The contents published in this user manual are protected by copyright. Reproduction or use is permitted for the internal use of the user. Duplication or use for other purposes is not permitted without the express written consent of KUNBUS GmbH. Contraventions will result in damages.

Trademark protection

- KUNBUS is a registered trademark of KUNBUS GmbH.
- Windows® und Microsoft® are registered trademark of Microsoft, Corp.

KUNBUS GmbH

Heerweg 15 C

73770 Denkendorf

Germany

www.kunbus.com

1.2 Notes Regarding this User Manual

This user manual provides important technical information that can enable you as a user to integrate the Gateway into your applications and systems efficiently, safely and conveniently. It is intended for trained, qualified personnel, whose sound knowledge in the field of electronic circuits and expertise of PROFINET is assumed.

As an integral part of the module, the information provided here should be kept and made available to the user.

1.3 Validity

This document describes the application of the Gateway product number:

- PR100069, Release 00

1.4 Limitation of Liability

Warranty and liability claims will lapse if:

- the product has been used incorrectly,
- damage is due to non-observance of the operating manual,
- damage is caused by inadequately qualified personnel,
- damage is caused by technical modification to the product (e.g. soldering).

1.5 Customer Service

If you have any questions or suggestions concerning this product, please do not hesitate to contact us:

KUNBUS GmbH
Heerweg 15 C
73770 Denkendorf
Germany
+49 (0)711 3409 7077
support@kunbus.de
www.kunbus.de

2 Safe Use

2.1 Intended Use

The modular gateway component is part of a gateway that can be combined with another modular gateway component or a RevPi Core/Connect from KUNBUS as required.

The modular gateway component is designed to forward data from a specific protocol to a controller or other gateway component.

No other purpose is intended. If you do not use the device as intended, damage to property and personal injury may result.

2.2 User

The Gateway may only be assembled, installed and put into operation by trained, qualified personnel. Before assembly, it is absolutely essential that this documentation has been read carefully and understood. Expertise in the following fields is assumed:

- electronic circuits,
- basic knowledge of PROFINET,
- work in electrostatic protected areas,
- locally applicable rules and regulations for occupational safety.

2.3 Symbols

The symbols used have the following meaning:

DANGER

Danger

Always observe this information!

There is a safety hazard that can lead to serious injuries and death.

CAUTION

Caution

There is a safety hazard that can result in minor injuries and material damage.

NOTICE

Note

There is a safety hazard that can result in material damage.

2.4 Important safety instructions

DANGER

Danger of explosion

The modular Gateway component do not meet the requirements of the ATEX directive. Therefore, they are not suitable for use in potentially explosive environments.

- Do not use the modular Gateway component in potentially explosive environments.

CAUTION

Electric shock

Switch off all voltages before assembly/disassembly.

- Failure to observe this warning may result in personal injury.

CAUTION

The devices are „open equipment“ according to the Standard UL61010-2-201.

To fulfill requirements for safe operation with regard to mechanical stability, flame retardation, stability, and protection against contact, the following alternative types of installation are specified:

- Installation in a suitable cabinet.
- Installation in a suitable enclosure.
- Installation in a suitable equipped, enclosed control room.

NOTICE

Incorrect connection of the power supply

Using an unsuitable power supply can destroy your modules and connected devices.

- Use a power supply in the approved area for the base modules. The values for this can be found in the technical data of your base module.

2.5 Environmental Conditions

To prevent damage, only operate the RevPi module in an environment that corresponds to the operating conditions.

Suitable ambient conditions:

Operating temperature	-30 °C to +55 °C
Air humidity	93% (no condensation)

NOTICE

This device is designed for indoor use only.

If you use the device outdoors, it may be destroyed.

→ Only use the device indoors.

2.6 Data safety

Please note that Gateway is not suitable for use in unprotected networks (e.g. the Internet).

Use Gateway in a secured network:

- Seal off your network so that no direct access via the Internet is allowed.
- Immediately change the default password for the web server. You can find out how to do this in the chapter "Changing the password". Select a secure new password.
- Check our website regularly for the latest software security alerts and updates for your product. Install the security updates provided by us.

If you do not follow these instructions, it is possible that your module data may be manipulated.

3 Overview

3.1 Functionality

The KUNBUS Gateway is a protocol converter. It allows communication between networks with different protocols.

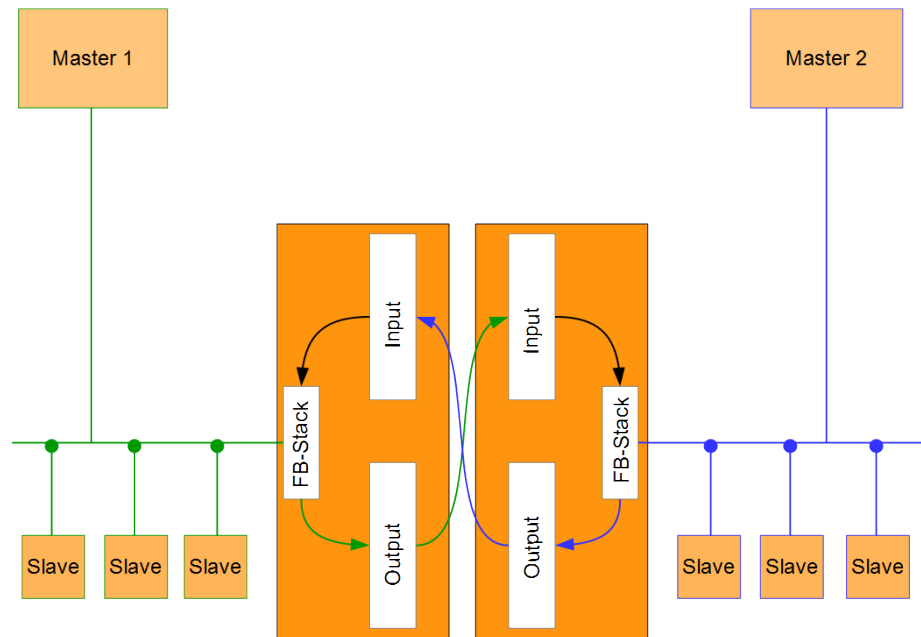

Illustration 1: Functionality as a slave

A Gateway consists of 2 gateway components that master one specific protocol each. You can combine these gateway components as you wish. This design offers you a high degree of flexibility, since you can exchange the individual gateway components at any time. The following gateway components are currently available as slaves:

- CANopen
- DeviceNet
- EtherCAT
- EtherNet/IP
- Modbus RTU
- Modbus TCP
- POWERLINK
- PROFIBUS
- PROFINET
- Sercos III

The gateway component for DMX can be operated as a master or slave.

In addition, you can combine the gateway components with the RevPi Core.

3.2 Control Elements

Front view

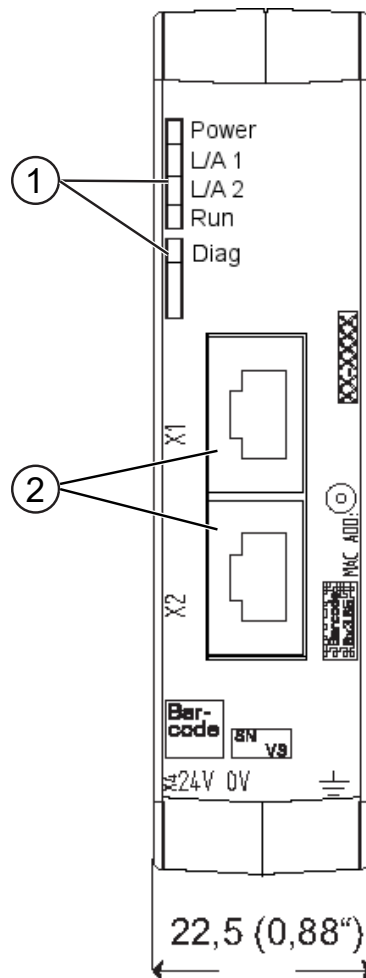

Illustration 2: Front view

1	Status LEDs
2	Fieldbus connection two RJ45 sockets for the connection to PROFINET PROFINET

Top view

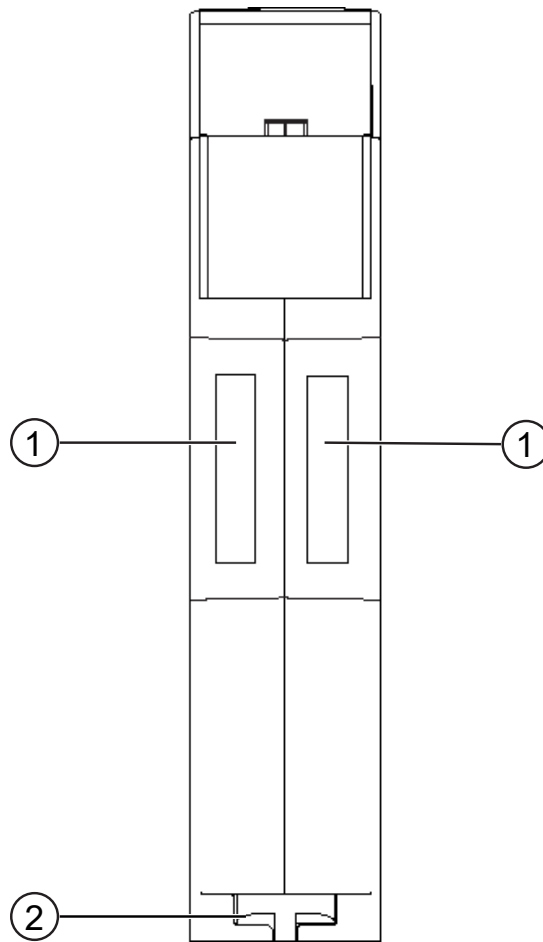
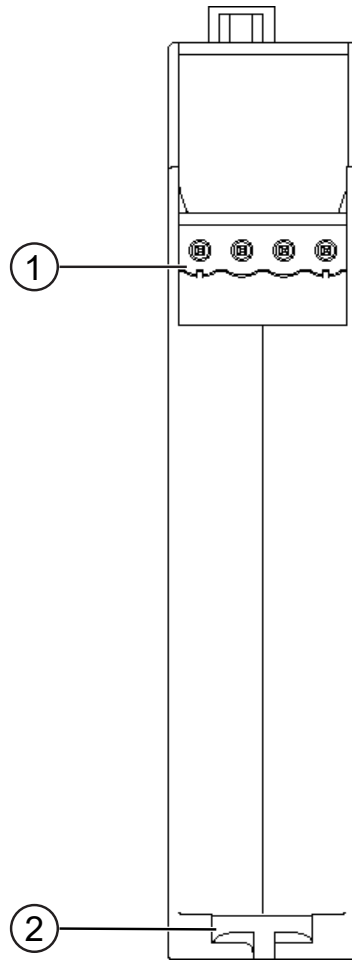

Illustration 3: Top view

1	Interconnect ports for interconnecting the gateway components.
2	Locking clamps for securely attaching the gateway component to the DIN rail.

Bottom view

*Illustration 4: Bottom view*

- | | |
|---|--|
| 1 | Mains connection
with 24 V supply voltage |
| 2 | Locking clamps
for securely attaching the gateway component to the DIN
rail. |

3.3 Status LEDs

The signals of the status LEDs for PROFINET have the following meaning:

LED Designation	Signal	Meaning
Power	off	Gateway not running
	flashes, green	Initialisation phase not yet completed
	on, green	Operational
	flashes, red	Correctable error (e.g. second gateway component missing)
	on, red	Serious error/defect in the gateway
Link/Traffic Port 1	off	No connection to a network
	on, green	Network cable is connected
	flashes, green	Data packets transmitted or received
Link/Traffic Port 2	off	No connection to a network
	on, green	Network cable is connected
	flashes, green	Data packets transmitted or received
Run	off	No connection to a network
	on, green	Profinet controller is in operating state
	1 flash, green	Profinet controller is connected, but no data processing takes place
	flashes 1 Hz, green	Signaling. Triggered by tool for identification of the gateway component
Diagnosis	off	Everything OK
	on, red	Gateway component reports diagnosis data
	flashes 2 Hz, red	No connection to the controller No PROFINET name set in the module
	flashes 1 Hz, green	Signaling. Triggered by tool for identification of the module

4 Installation

4.1 Preparations for Inteference-free Operation

In the following section we have compiled some general information for you that is important for trouble-free operation. If you are already acquainted with this topic, you can skip to the next section. There, you will learn about which conditions are necessary for installing the gateway.

Cable routing

Route your cables separately in cable groups. This will protect your gateway from any unintended electromagnetic interferences.

The following groups should be routed separately from each other:

Group	Line
A	Data and power supply lines for: DC voltage below 60 V AC voltage below 25 V
B	Data and power supply lines for: DC voltage between 60 V and 400 V AC voltage between 25 and 400 V
C	Power supply lines above 400 V

- You can route cables of the same group together in cable ducts or bundles.
- Cables of group A and B:
 - Route the groups in separate bundles or
 - in cable ducts at a minimum distance of 10 cm from each other.
- Cables of group C
 - Route the groups in separate bundles or
 - in cable ducts at a minimum distance of 50 cm from the other groups.

Shielding

Shield your cables. This will reduce any unintended electromagnetic interferences.

Potential equalization

Potential differences occur when devices are connected to different earths. These potential differences cause malfunctions.

To prevent malfunctions, you have to route an equipotential equalization conductor.

When doing so, bear in mind the following points:

- Select an equipotential equalization conductor with low impedance.
- Select the following as a reference value for the cross-section of the potential equalization cable:
 - 16 mm² for potential equalization cables of up to 200 m in length
 - 25 mm² for potential equalization cables of more than 200 m in length
- Use potential equalization cables made of copper or galvanized steel.
- Connect potential equalization cables extensively with the earth rail.
- The smallest surfaces possible should be sandwiched between potential equalization cables and signal cables.

If the devices of the control system are connected by shielded signal cables that are earthed on both sides, the impedance must be 10% of the shielding impedance.

4.2 Requirements

The Gateway was designed for use in a control cabinet.

- ✓ The protection class of the control cabinet must be equivalent to at least IP54.
- ✓ For installation in the control cabinet you need a DIN rail 35 x 7.5 mm (EN50022).
 - Install the DIN rail horizontally in the control cabinet according to the manufacturers' specifications. When doing so, make sure that the Gateway is at a sufficient distance from other devices.

NOTICE

Your gateway could be damaged if temperatures are too high.

- ➔ Make sure that the ambient temperature in the control cabinet is less than 60 °C.
- ➔ Keep the ventilation slots unobstructed. These must not be covered by cables etc.
- ➔ Maintain sufficient distance from other devices.

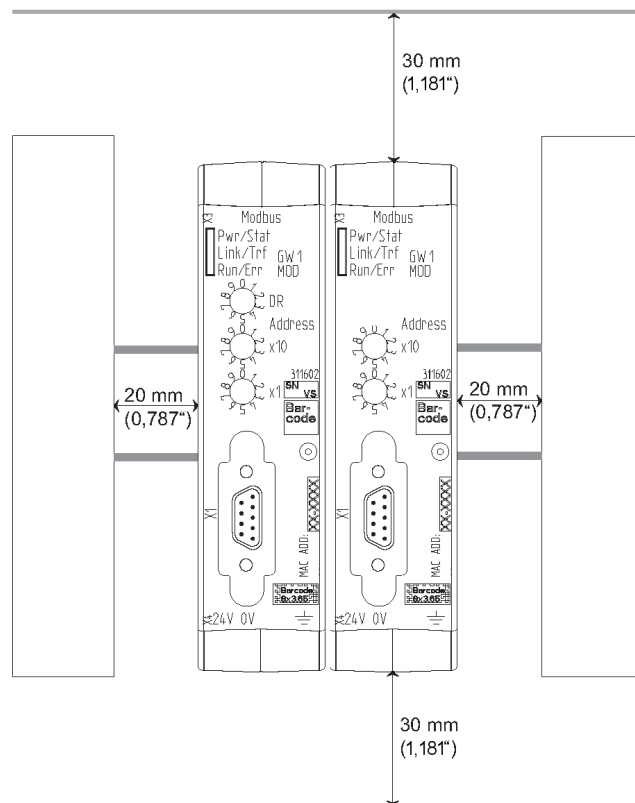

Illustration 5: Distances for installation

- Connect each gateway component individually to functional earth. When doing so, make sure that the power supplies of both gateway components have the same ground.
- ⇒ Your control cabinet now meets all requirements for installing the gateway.

4.3 Connecting Gateway Components

In order to attain a fully functional gateway, you have to interconnect both gateway components.

- Connect an interconnect port to each gateway component using the plug-in jumper (product number PR100204).

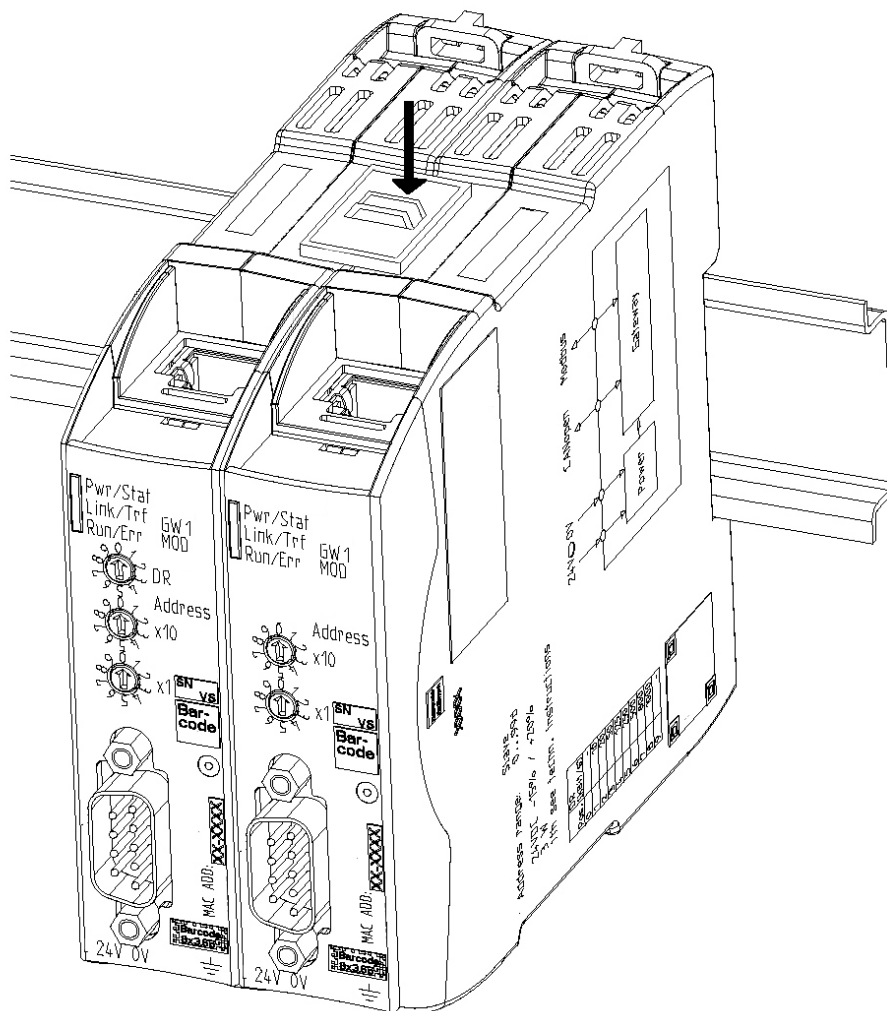

Illustration 6: Connecting gateway components

⇒ You can now install the gateway in the control cabinet.

NOTICE

Only ever interconnect 2 gateway components.

If you connect additional components, severe defects could result on all devices.

4.4 Installing a Gateway in the Control Cabinet

- Hold the raster element of the gateway on the DIN rail.
- Press down the locking elements towards the gateway.
- Make sure that the gateway is firmly attached to the DIN rail.

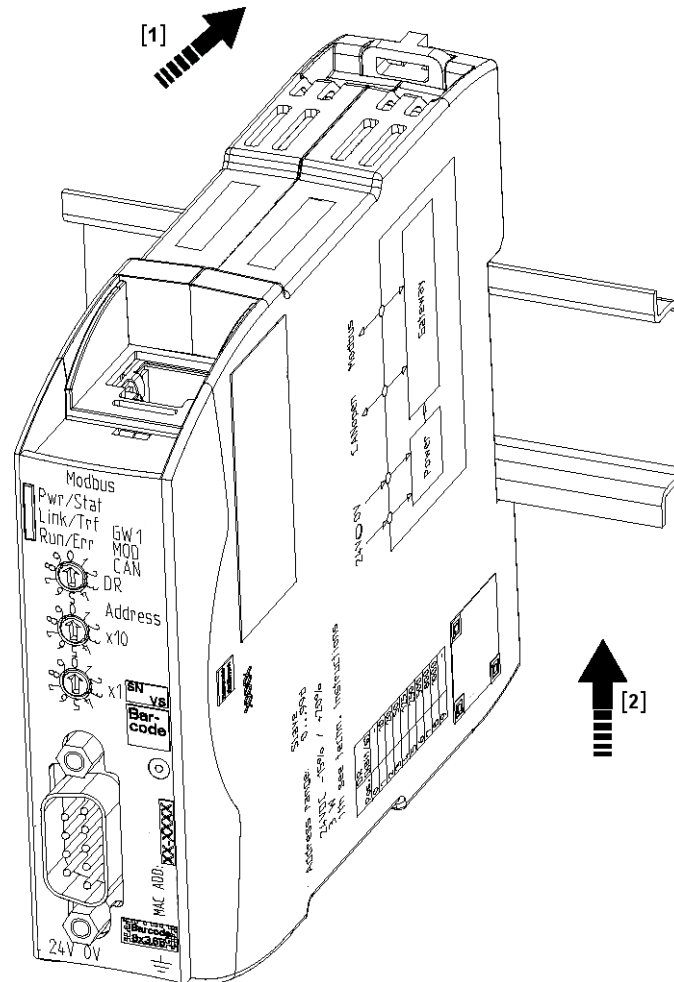

4.5 Connecting a Power Supply

To connect the gateway component to the power supply, you need a spring-loaded terminal (e.g. Metz-Connect SP995xxVBNC).

You have to connect each gateway component separately to a power supply. Never interconnect functional earth and GND, otherwise the galvanic isolation between gateway GND and fieldbus ground will be removed. Instead, connect the functional earth with low impedance to the potential equalization. You can then dispense with this connection if the shield of the fieldbus cable is connected to the potential equalization with lower impedance when entering the control cabinet.

NOTICE

Connect each of the two gateway components to the power supply

→ Ensure in particular that no potential differences occur between the GND pins (2).

Pin assignment:

Pin	Assignment
1	24 V for module supply
2	GND
3	Do not connect!
4	Functional earth

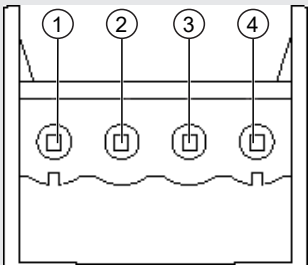

NOTICE

Do not connect GND to PE

This connection could cause unintended malfunctions.

4.6 Connecting a Gateway to the Fieldbus

To connect the gateway component to PROFINET, you need two RJ45 connectors.

The pin assignment complies with the specifications of the PNO.

Pin	Meaning
1	TX+
2	TX-
3	RX+
4	Do not connect!
5	Do not connect!
6	RX-
7	Do not connect!
8	Do not connect!

5 Configuration

5.1 Supported size of process data

The gateway component for PROFINET supports an input and output area of 512 bytes each:

- The first 320 bytes of each area are intended for the exchange of cyclical process data.
- The remaining 192 bytes can be used for acyclic data exchange (records).

NOTICE

Bear in mind that the maximum length of the process data is always determined by the fieldbus with the shorter data length.

5.2 Setting Station Name

Since names are easier to handle than complex IP addresses in most cases, you can assign a station name to the gateway component.

You set the station name using the software of your PROFINET controller.

According to the definition RFC 5890, attention must be paid to the name assignment rules in this regard:

- Data should be specified in the Octet string type
- Restriction to a total of 240 characters (letters "a" to "z", numbers "0" to "9", hyphen or dot)
- A name element of the device name must be separated with a dot and can have a maximum of 63 characters.
- No special characters such as umlauts, brackets, underscore, blank etc.
- The hyphen is the only special character allowed.
- The device name must not begin or end with a dot.
- The device name must not begin with numbers.
- The device name must not have the form n.n.n.n (n = 0...999).
- The device name must not begin with the character string "port-xyz-" (x,y,z = 0...9).
- The device name may only begin with "xn-" if the original character string contains values other than "0" to "9" and "a" to "z".
- The field "NameOfStationValue" must not end with 0.

Examples of valid names:

"device -1.machine- 1.plant- 1.vendor"
 "mühle1.ölmühle1.plant.com" is coded as " xn-mhle1-kva.xn-lmhle1 -
 vxa4c.plant.com"

5.3 Exchanging Data cyclically

To configure the gateway component, you have to perform the appropriate settings with the configuration software of your PROFINET -Controller.

The gateway component is equipped with virtual slots (installation positions). PROFINET controllers use these slots to address selected process data. Each slot contains one module. You can assign process data to these modules that are to be exchanged.

Slot	Module	Id	Offset
0	DAP	0x80050000	--
1	Input 16	0x00000005	Output Off 0
2	Input 16	0x00000005	Output Off 16
3	Input 32	0x00000006	Output Off 32
4	Input 32	0x00000006	Output Off 64
5	Input 32	0x00000006	Output Off 96
6	Input 64	0x00000007	Output Off 128
7	Input 64	0x00000007	Output Off 192
8	Input 64	0x00000007	Output Off 256
9	Output 16	0x00000050	Input Off 0
10	Output 16	0x00000050	Input Off 16
11	Output 32	0x00000060	Input Off 32
12	Output 32	0x00000060	Input Off 64
13	Output 32	0x00000060	Input Off 96
14	Output 64	0x00000070	Input Off 128
15	Output 64	0x00000070	Input Off 192
16	Output 64	0x00000070	Input Off 256

Info! The gateway component supports only a submodule with data per module.

In the following tables you will find a detailed overview of all modules.

DAP (Device Access Point)

Description:	DAP
Module ID	0x80050000
Usable in Slot:	0
Total Number of Input Bytes:	0
Total Number of Output Bytes:	0
Number of Submodules	3

Submodule for Record Access

Submodule ID	0x00000001
Subslot:	0x0001
Number of Input Bytes	0
Number of Output Bytes	0

Submodule that represents the entire Profinet Device

Submodule ID	0x0000000a
Subslot:	0x8000
Number of Input Bytes	0
Number of Output Bytes	0

Submodule that represents Port 1

Submodule ID	0x0000000b
Subslot:	0x8001
Number of Input Bytes	0
Number of Output Bytes	0

Submodule that represents Port 2

Submodule ID	0x0000000c
Subslot:	0x8002
Number of Input Bytes	0
Number of Output Bytes	0

Input 16 Byte

Description:	Input 16 Byte
Module ID	0x00000005
Usable in Slot:	1 – 8
Total Number of Input Bytes:	16
Total Number of Output Bytes:	0
Number of Submodules	1
Submodule ID	0x00000001

Subslot:	0x0001
Number of Input Bytes	16
Number of Output Bytes	0

Input 32 Byte

Description:	Input 32 Byte
Module ID	0x00000006
Usable in Slot:	1 – 8
Total Number of Input Bytes:	32
Total Number of Output Bytes:	0
Number of Submodules	1

Submodule ID	0x00000001
Subslot:	0x0001
Number of Input Bytes	32
Number of Output Bytes	0

Input 64 Byte

Description:	Input 64 Byte
Module ID	0x00000007
Usable in Slot:	1 – 8
Total Number of Input Bytes:	64
Total Number of Output Bytes:	0
Number of Submodules	1

Submodule ID	0x00000001
Subslot:	0x0001
Number of Input Bytes	64
Number of Output Bytes	0

Output 16 Byte

Description:	Output 16 Byte
Module ID	0x00000050
Usable in Slot:	1 – 8
Total Number of Input Bytes:	0
Total Number of Output Bytes:	16
Number of Submodules	1

Submodule ID	0x00000001
Subslot:	0x0001
Number of Input Bytes	0
Number of Output Bytes	16

Output 32 Byte

Description:	Output 32 Byte
Module ID	0x00000060
Usable in Slot:	1 – 8
Total Number of Input Bytes:	0
Total Number of Output Bytes:	32
Number of Submodules	1

Submodule ID	0x00000001
Subslot:	0x0001
Number of Input Bytes	0
Number of Output Bytes	32

Output 64 Byte

Description:	Output 64 Byte
Module ID	0x00000070
Usable in Slot:	1 – 8
Total Number of Input Bytes:	0
Total Number of Output Bytes:	64
Number of Submodules	1

Submodule ID	0x00000001
Subslot:	0x0001
Number of Input Bytes	0
Number of Output Bytes	64

5.4 Exchanging Data acyclically (Records)

The gateway component supports records. This access type is useful for all events that do not have to be repeated regularly (e.g. sending parameter data in the start-up phase).

Another benefit of records is due to the fact that you can write continuously ascending areas at once.

Example:. Index 0x1005 writes byte 10 to byte 19 with 10 bytes of data in the output process mapping.

You can use all 512 bytes of the input and output area to read or write records.

NOTICE

Bear in mind that the first 320 bytes of the input and output area are used for cyclical data transmission.

Records that you address with index 0x0000 – 0x00ff or 0x1000 – 0x10ff, can be overwritten by the cyclical data transmission.

Addressing

All records are addressed via API 0, Slot 0, Subslot 1. The data is transferred in Little Endian format. In the case of Big-Endian format, the higher-value bytes are first transmitted and stored at the memory locations with the lowest addresses.

2 bytes are always addressed per index:

Offset 0 + Offset 1 → Record 0

Offset 510 + Offset 511 → Record 255 (0x00ff)

Index 0x0000 – 0x00ff contains the input data sent from the partner gateway component.

Index 0x1000 – 0x10ff contains the output data sent to the partner gateway component.

State of the Partner Gateway You can read information on the state of the partner gateway component via API 0, Slot 0, Subslot 1, Index 0x2000:

Offset	Length	Element	Comment
0	4	Serial number	
4	2	Module type	KUNBUS internal module type
6	2	Hardware Revision	
8	2	Major Software Version	
10	2	Minor Software Version	
12	4	Subversion Revision	Source Code Version
16	2	Fieldbus Input Length	
18	2	Fieldbus Output Length	
20	1	Bus State	
20	2	Feature descriptor	Supported features of the gateway

5.4.1 I&M Data

Identification & Maintenance Functions

I&M functions are data functions whose sole purpose is to clearly identify the gateway component in the PROFINET.

The gateway component supports I&M functions 0-4. These I&M functions are available in Slot0, Subslot 1. The data from the PROFINET Controller can be read and, if necessary, written via the data index 0xaff0-0xaff4.

I&M 0 data

I&M 0 contains information about the gateway component. It can be read from the PROFINET-Controller with Api0, Slot0, Subslot1, Index 0xaff0 via Record Read.

You will find the following information about the gateway component via the I&M 0 data:

- Vendor ID
- Order ID
- Serial Number
- Hardware Revision
- Software Revision
- Revision Counter
- Profile ID
- Profile specific type
- I&M Version

I&M 1 data

I&M 1 data is stored permanently in the gateway component. It can be read and written from the PROFINET-Controller with Api0, Slot0, Subslot1, Index 0xaff1 via Record Read

I&M 2 data

I&M 2 data is stored permanently in the gateway component. It can be read and written from the PROFINET-Controller with Api0, Slot0, Subslot1, Index 0xaff2 via Record Read

I&M 3 data

I&M 3 data is stored permanently in the gateway component. It can be read and written from the PROFINET-Controller with Api0, Slot0, Subslot1, Index 0xaff3 via Record Read

I&M 4 data

I&M 4 data is stored permanently in the gateway component. It can be read and written from the PROFINET-Controller with Api0, Slot0, Subslot1, Index 0xaff4 via Record Read.

5.4.2 Diagnosis Alarm

If communication to the partner gateway component is interrupted, the gateway component for PROFIBUS sends a diagnosis alarm to the controller:

- The alarm is sent out from API 0, Slot 0, Subslot 1
- The alarm is sent as channel diagnosis with channel 0x8000
- The alarm has the priority "Maintenance Required",
- Error type is 0x0100 (first user defined error)
 - Check whether the plug-in jumper is connected correctly to both module components.
 - Check whether the partner gateway component is connected to the power supply.

As soon as communication functions again, the PROFINET controller sends a diagnosis telegram to the gateway component.

You can find detailed information about the Diagnosis Alarm in the specifications for PROFINET.

6 Integrated servers

6.1 FTP-Server

The FTP server is necessary to update HTML files of the web server and to transfer firmware updates to the module.

You can access the FTP server from user level 2. The same credentials are valid as for the web server. The "Level" is defined in the file "password.xml". You can find out how to do this in the section „Logging on to the web server“. [} 29]

Web server files

The files for the web server can be found in the subfolder "Web".

6.2 Webserver

The Gateway has a web server. You can access it from any browser.

Access web server

- Verbinden Sie das Gateway mit dem PC.
 - Open your browser.
 - Enter the IP address as URI (e. g.: http://192.168.0.8)
- ⇒ You can log in now.

Log on to web server

You can log on to the web server as an administrator or as a user..

The user can:

- Read process data of the Gateway.

Logon data (default):

Username: User

Password: 1111

The administrator can:

- Change password
- Change network settings

Logon data (default):

Username: Admin

Password: 1701

Create user

To be able to check and manage login data, you must create a file named "password.xml" in the main directory of the module.

In this file, define the following 3 XML elements for each user:

- <UserX>,
- <PasswordX>,
- <LevelX>.

X represents a digit between 0 and 9. Assign a digit to each user. Make sure that the digit is not already used for another user.

User name and password may consist of up to 20 characters. Spaces are allowed. At "Level" you have to enter a positive integer. If this is at least 2, then the user is an "administrator".

Example for a "password.xml":

```
<?xml version="1.0" encoding="UTF-8"?>
<Passwords>
<User0>UserOne</User0>
<Password0>93h31m</Password0>
<Level0>1</Level0>
<User1>UserTwo</User1>
<Password1>53cr3t</Password1>
<Level1>3</Level1>
</Passwords>
```

Tip! As admin you can change the password directly in the web server.

Display process data

The transmitted data can be displayed cyclically for the interfaces available in the selected mode..

Click on the "Show" buttons to view the process data of the desired input and output area. The following example shows the process data of the fieldbus.

6.3 Firmware Update

The following sections explain how to update the firmware of your modular gateway.

You will need them:

- Windows PC
- Gateway
- LAN cable
- FTP-Software (e. g. Filezilla)

Configure network

To access the FTP server, you must create a network configuration. For this example, we will use these settings:

- Network 192.168.1.0/24
- IP address Windows PC 192.168.1.1
- IP address GW-ProfiNET-TPS-1 192.168.1.10
 - Click on „Start“.
 - Select „System Control“.
 - Click on „ Network and Sharing Center “.
 - Click on „ Change Adapter Settings “.

Configure IP address
(Windows PC)

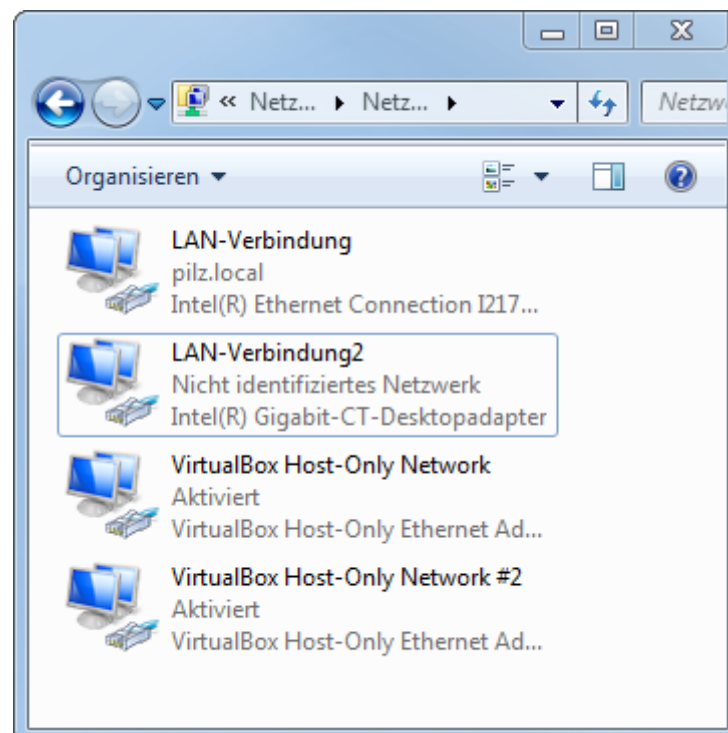

- Click with the right mouse button on the desired connection.

- Select „Properties “.

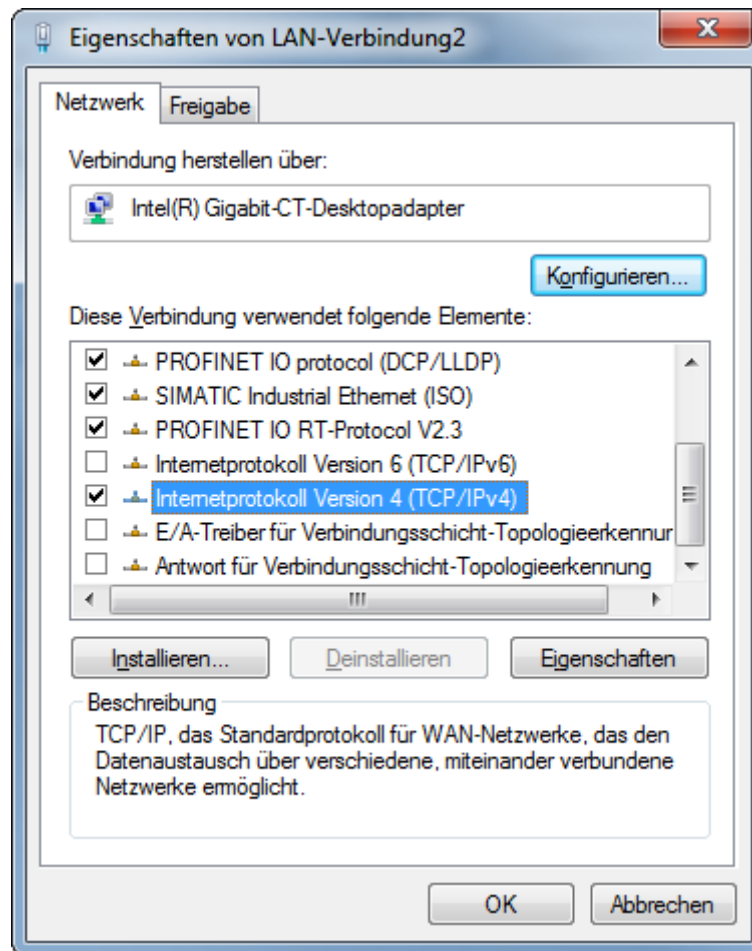

- Select “Internet Protocol Version 4” with a double click.
- Set the desired IP address.
- Click on „OK“.

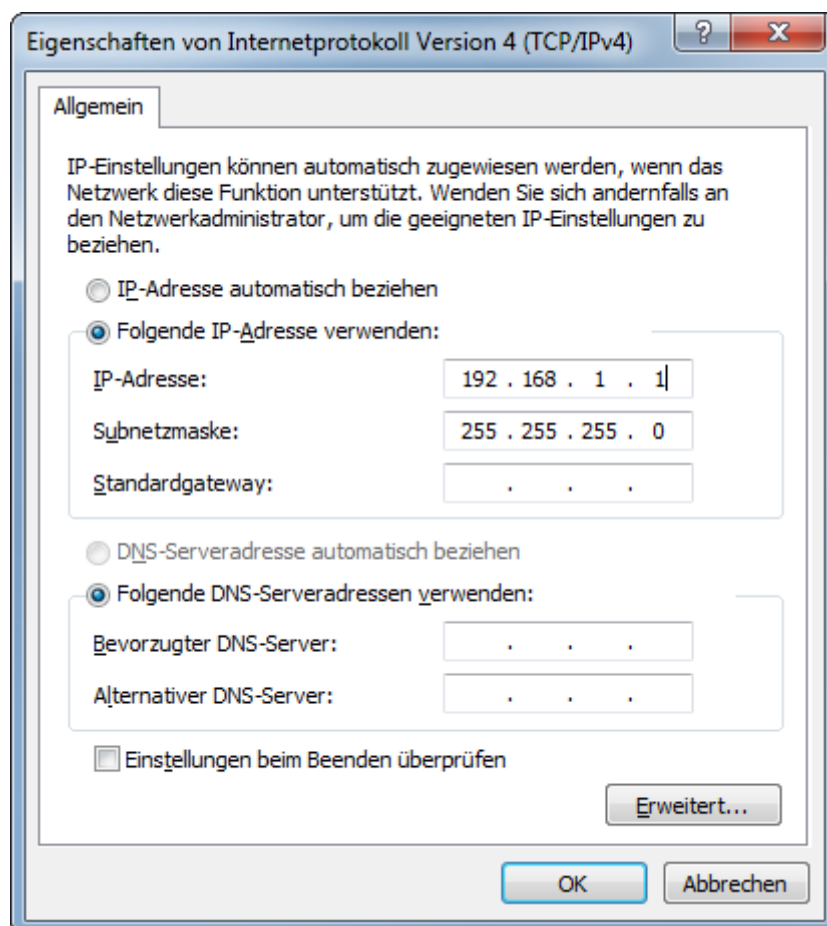

Connecting the Gateway to the PC

- Connect the Ethernet interface of the modular gateway to the Ethernet interface on your PC. A LAN cable is required.
- Download Proneta to your PC.
- Unpack the current version.

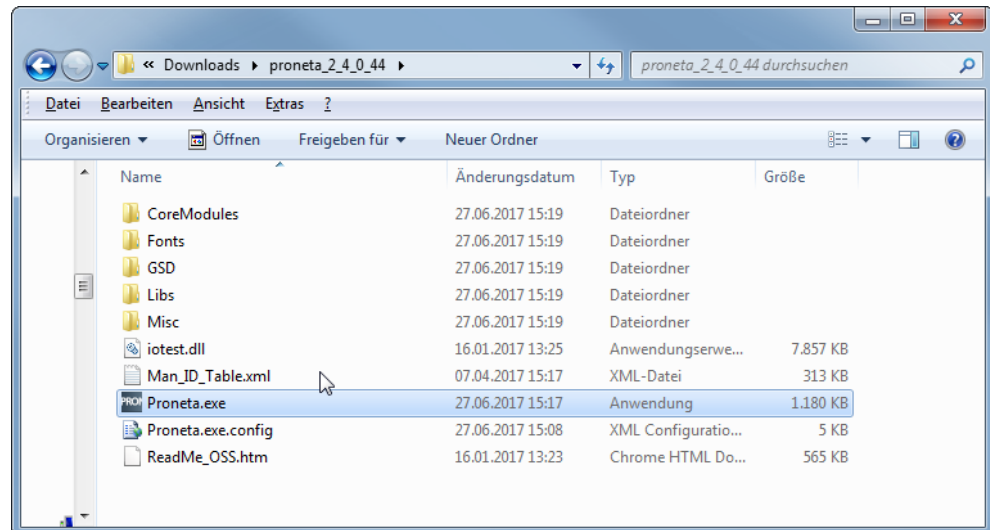

- Open "Proneta.exe" with a double click.
- ⇒ Proneta is opened.

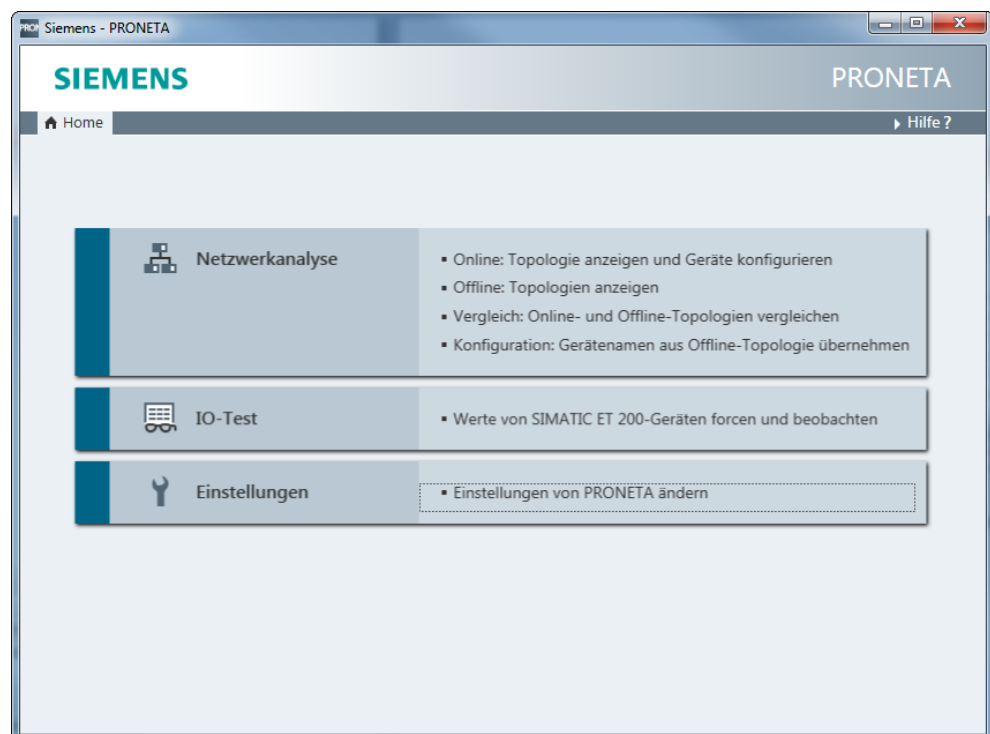

- Click on „Settings“.
- Click on the "Network Adapter" tab.
- Select the desired network interface.

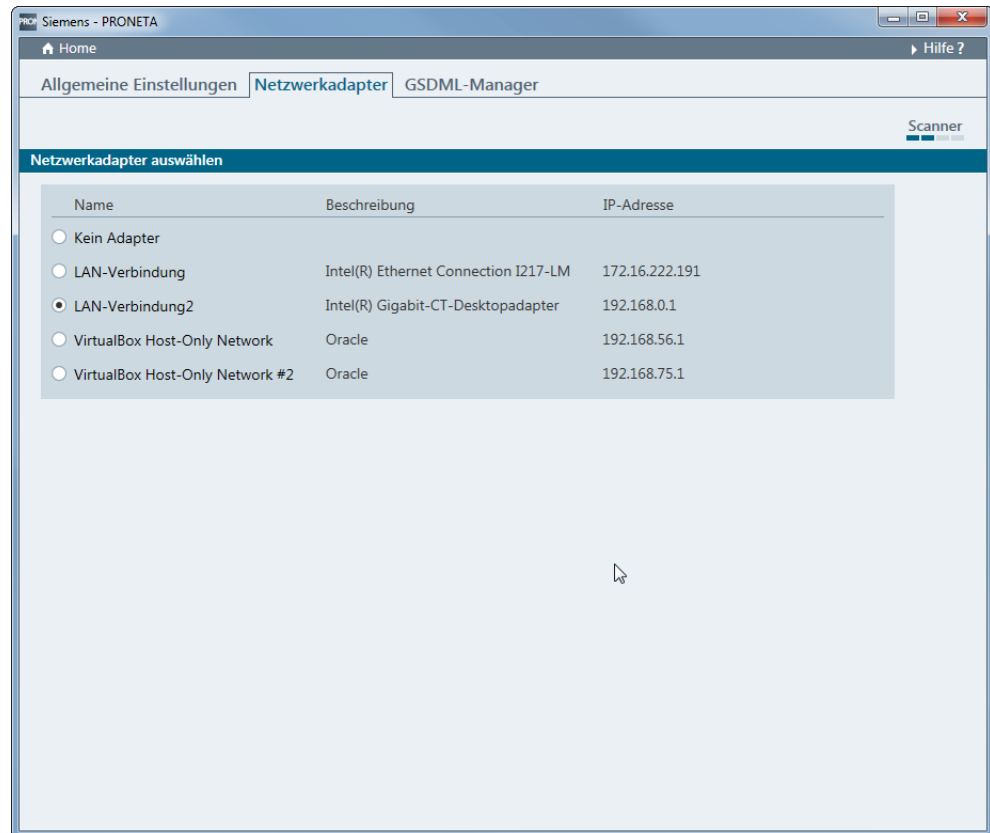

- Click on „Home“.

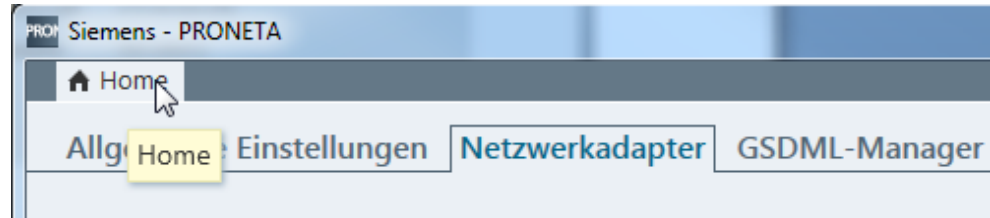

- Click on „ network analysis “.
- ⇒ The network analysis opens. The network connection between Windows PC and the modular gateway is displayed..

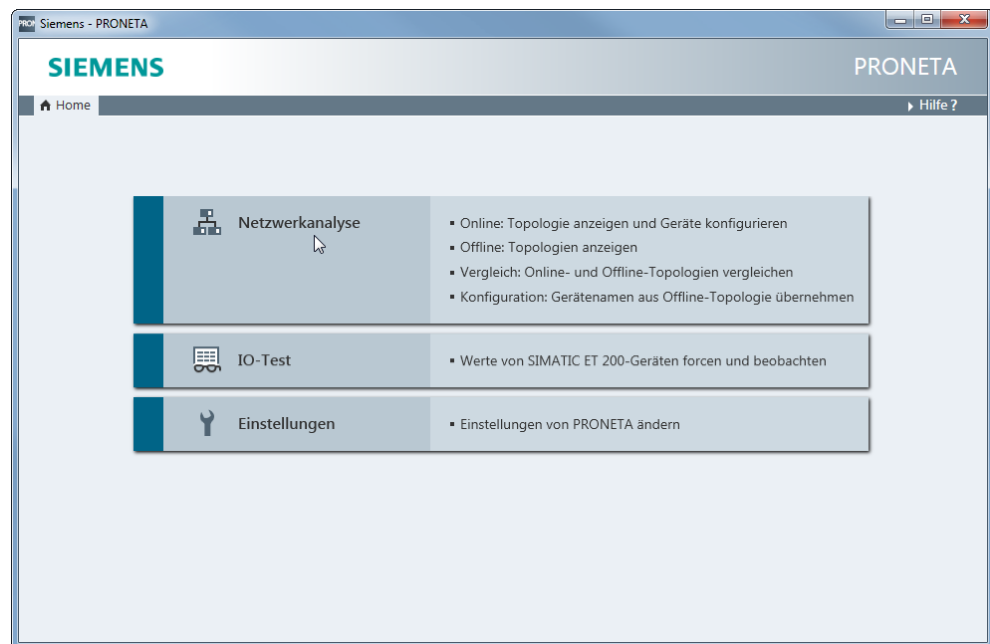

- Select the modular gateway by double-clicking it.

- ⇒ The configuration interface opens.
- Enter the network configuration here.

http://www.siemens.com/industrialsecurity'."/>

Netzwerkparameter setzen

Bitte wählen Sie Ihre Netzwerkparameter aus

Gerätenamen zuweisen

IP-Konfiguration

Statische IP-Konfiguration

IP-Adresse

Netzwerkmaske

Router als Gateway verwenden

IP-Konfiguration vom DHCP-Server ermitteln gemäß

MAC-Adresse

Geräteiname

Client-ID

Geräte, die an ein Firmennetzwerk oder an das Internet angeschlossen werden, müssen gegen unbefugten Zugriff angemessen geschützt sein, z. B. durch die Verwendung von Firewalls und Netzwerksegmentierung. Weiterführende Informationen über Industrial Security finden Sie unter <http://www.siemens.com/industrialsecurity>

Einstellungen dauerhaft anwenden

Setzen Abbrechen

- Click on „Set“.

⇒ The IP address is now set.

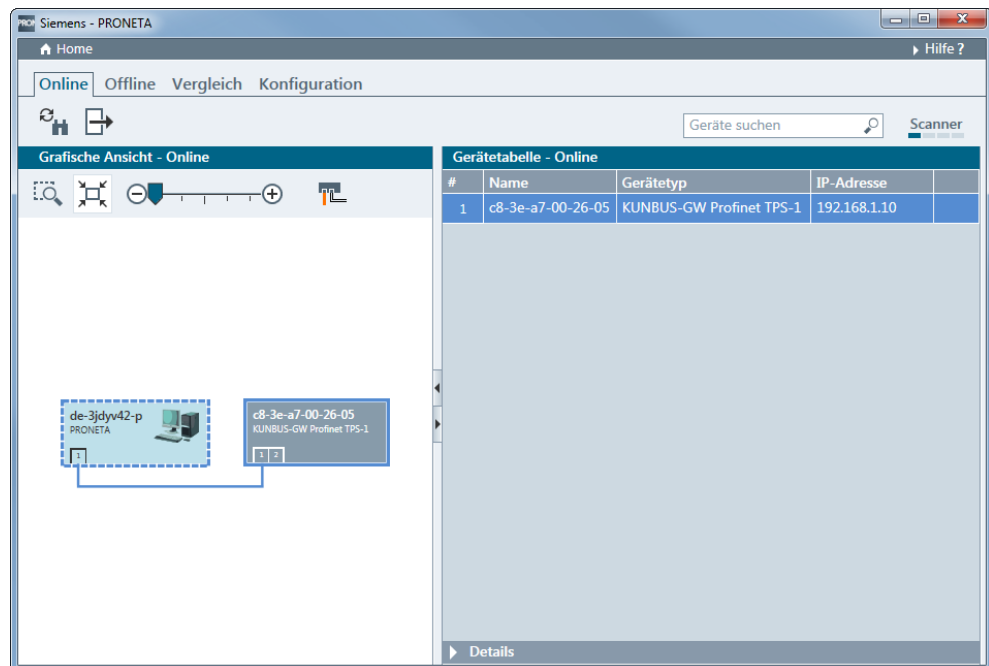

- Open the Windows console (with Windows+R "cmd").
- Enter "ping" and the IP address of the modular gateway.

This allows you to verify that the configuration is correct.

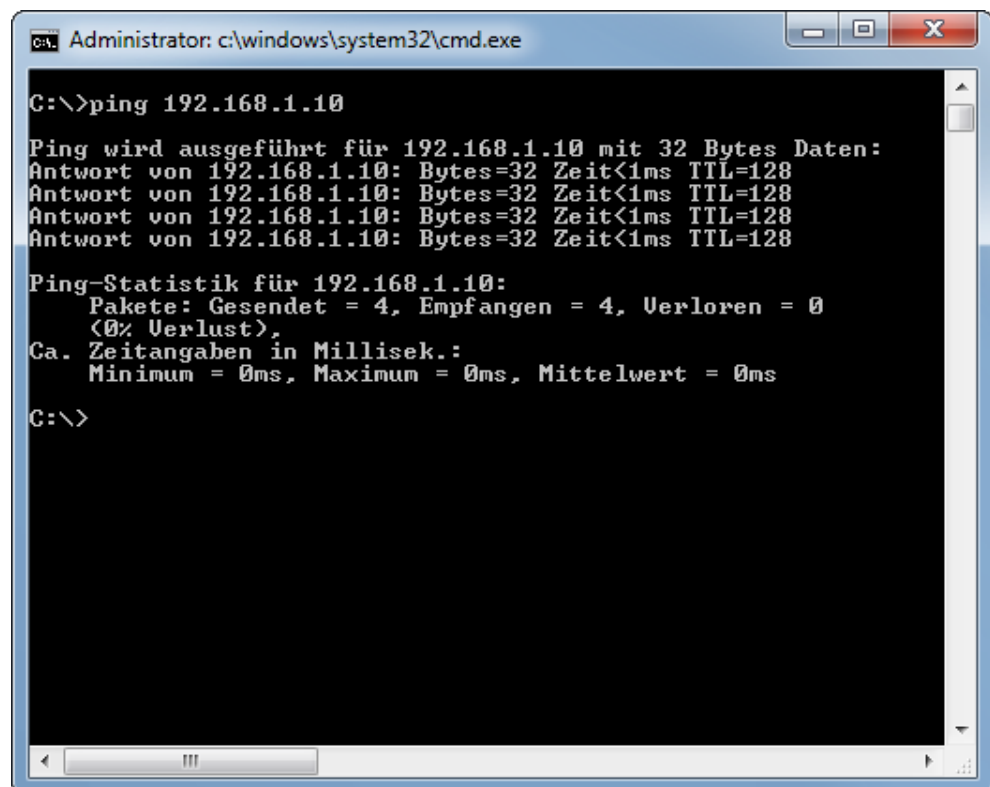

Set up FTP server

- ✓ You have installed a program for data transfer. In this example we use FileZilla. You can also use other software.
- Open FileZilla.
- Click on „New server“.
- Set the following parameters in the "General" tab:
 - IP address
 - Select "FTP" protocol
 - User (Admin)
 - Password (1701).

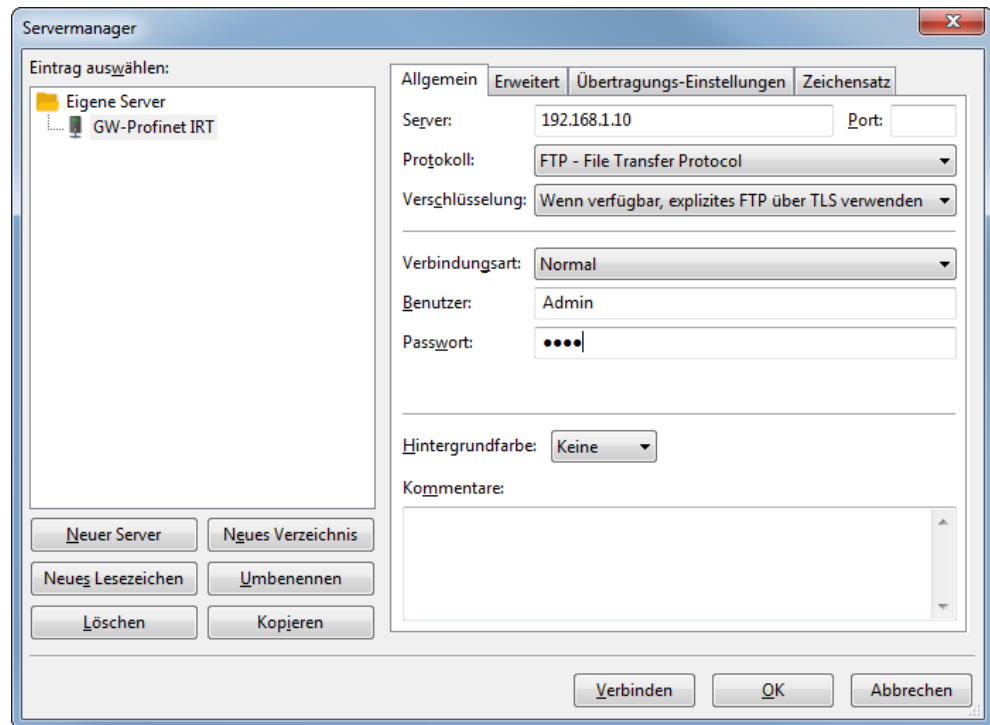

- Click on the "Advanced" tab.
- Check the box "Bypass proxy".

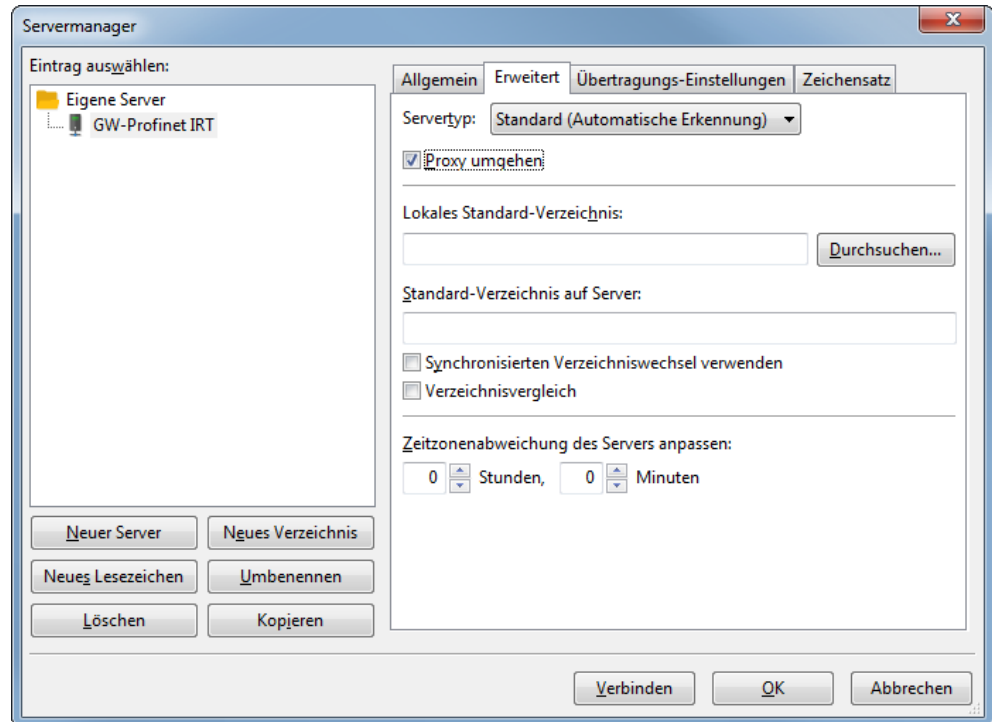

- Click on „Connect“.

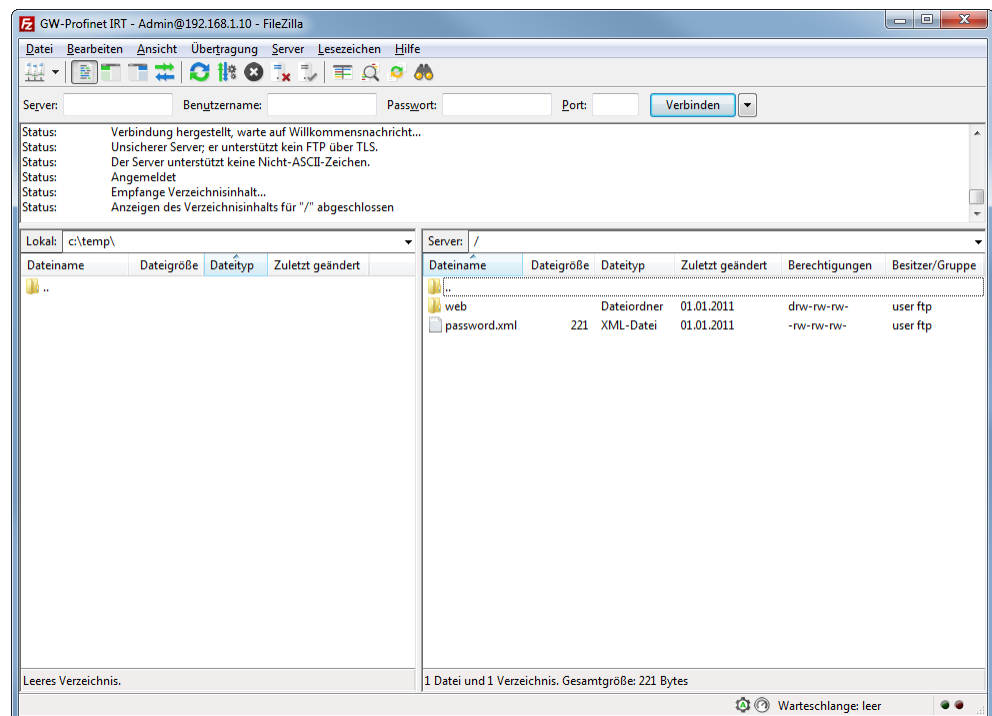

- Copy the KFU file to the device.

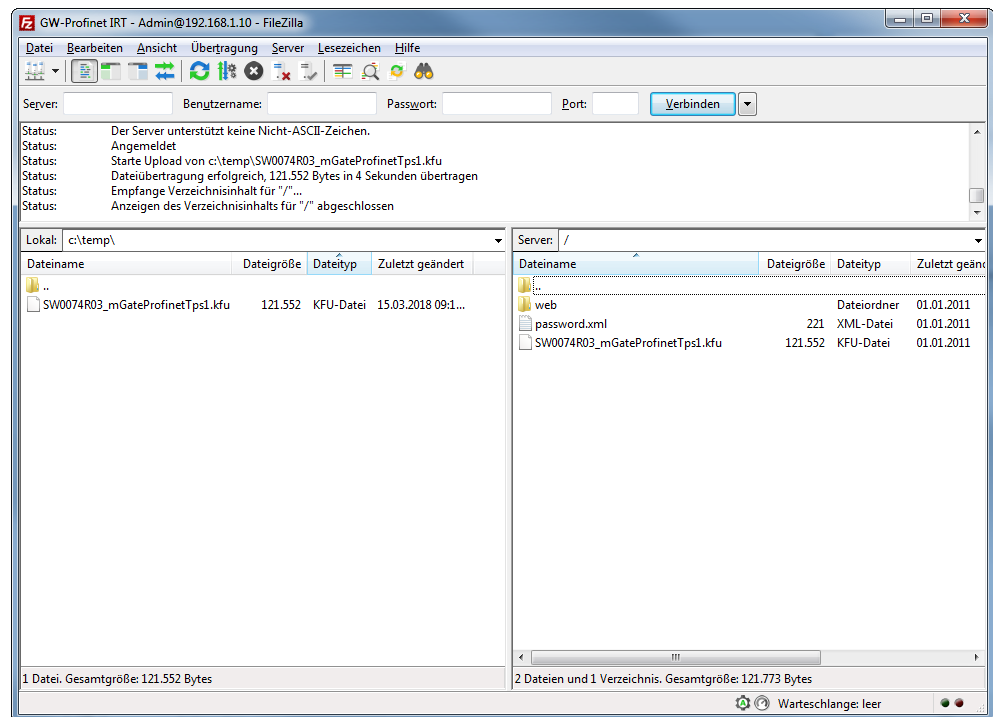

- Restart the device.
- ⇒ Your firmware has been updated.

7 Technical Data

7.1 Technical Data

Dimensions	
Width	22.5 mm
Height	96 mm
Depth	110.4 mm
Weight	90 g

Electrical data	
Power supply	12 -24 VDC -15%/ +20%; 1,5W
Power consumption during operation (cyclical data exchange)	100 mA
Source of Supply	The device may only be supplied from circuits that comply with Class 2 or Safety Extra Low Voltage (SELV) according to Class 9.4 of UL 61010-1
Status display	LED

Environmental conditions	
Ambient temperature	0 – 55 °C
Storage temperature	- 25 – 60 °C
Humidity	93% (at 40 °C)
Condensing	Not allowed
Protection class	
Control cabinet	IP54
Housing	IP20
Terminal area	IP20

Assembly data	
DIN rail	35 x 7.5 mm
Height	96 mm
Depth	110.4 mm

PROFINET Interface	
Device Type	Slave
Protocol	IRT
Maximum data length	
Total	1024 byte
– Input data	– 512 byte
– Cyclical data exchange	– 320 byte
– Acyclic data exchange	– 192 byte
– Output data	– 512 byte
– Cyclical data exchange	– 320 byte
– Acyclic data exchange	– 192 byte
Bitrate	100 MBit

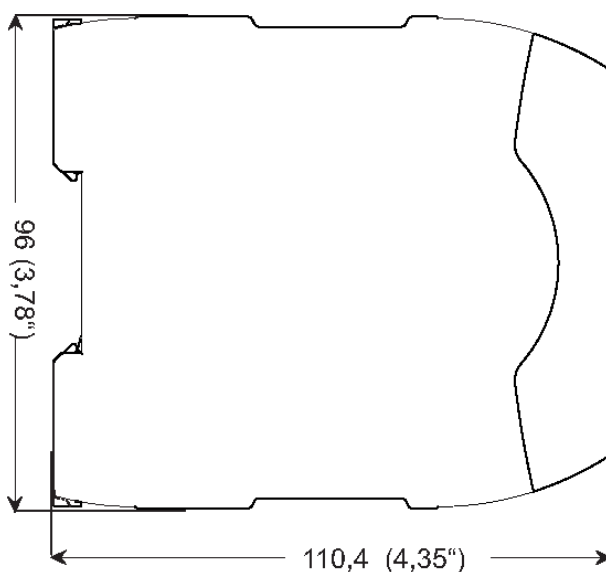

Illustration 7: Side dimensions

