

## 2-conductor through terminal block

Item No.: 281-901



2-conductor through terminal block

### Marking

RoHS ✓  
Compliant

### Business data

Supplier	WAGO
Item no.	281-901
GTIN / EAN	4044918485050
Content	1
Order amount	50
Customer item number	

### Notes

### Technical data

#### Miscellaneous

Total number of connection points	2
Total number of potentials	1
Color	gray
Ratings according to 1	IEC/EN 60947-7-1
Pollution degree (1)	3
Rated voltage EN (1) [V]	800 [V]
Rated surge voltage (1) [kV]	8 [kV]
Nominal current [A]	32 [A]
Connection technology (1)	CAGE CLAMP®
Solid sizes 1	0.08 ... 4 mm <sup>2</sup> / 28 ... 12 AWG

<b>Technical data</b>	
<i>Fine-stranded wires 1</i>	<i>0.08 ... 4 mm<sup>2</sup> / 28 ... 12 AWG</i>
<i>Strip length 1</i>	<i>9 ... 10 mm / 0.35 ... 0.39 in</i>
<i>Type of wiring</i>	<i>Front-entry wiring</i>
<i>Design</i>	<i>horizontal</i>
<i>Marking level</i>	<i>Center marking</i>
<i>Insulating material</i>	<i>Polyamide 66 (PA 66)</i>
<i>Fire load [MJ]</i>	<i>0.149 [MJ]</i>
<i>Weight [g]</i>	<i>8.154 [g]</i>
<i>Width</i>	<i>6 mm / 0.236 in</i>
<i>Height from upper-edge of DIN-rail [mm]</i>	<i>29 [mm]</i>
<i>Height from upper-edge of DIN-rail</i>	<i>29 mm / 1.142 in</i>
<i>Length</i>	<i>59 mm / 2.323 in</i>
<i>Type of mounting</i>	<i>DIN 35 rail</i>

Images & drawings

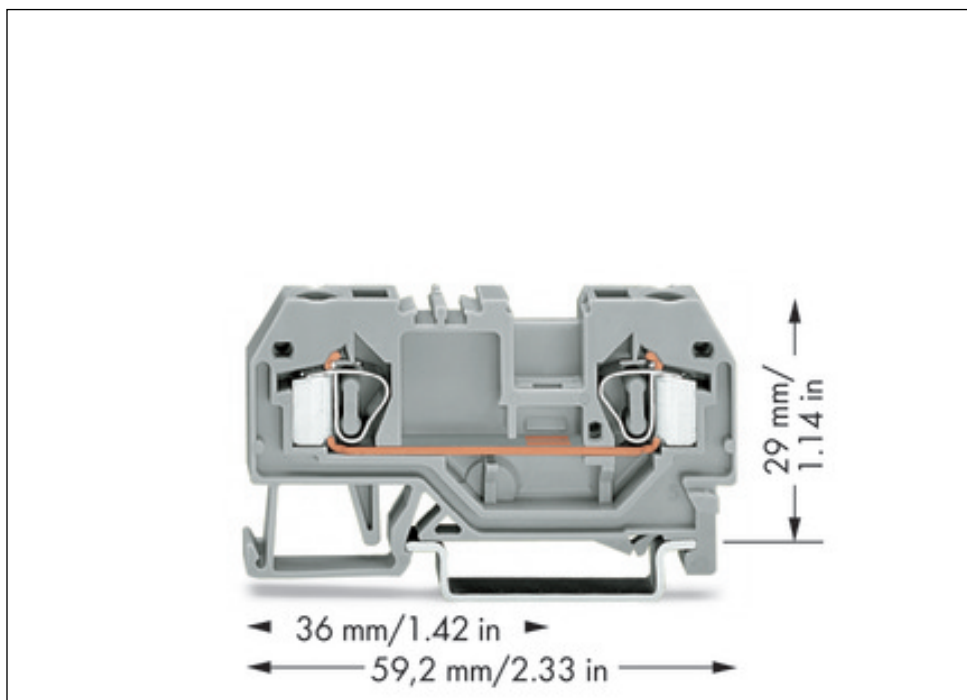
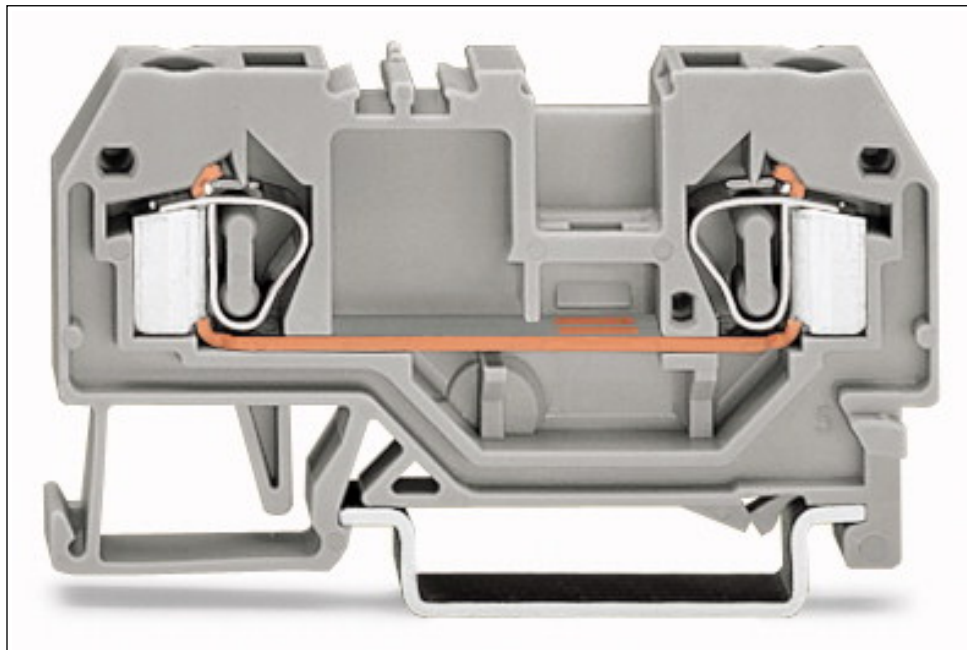

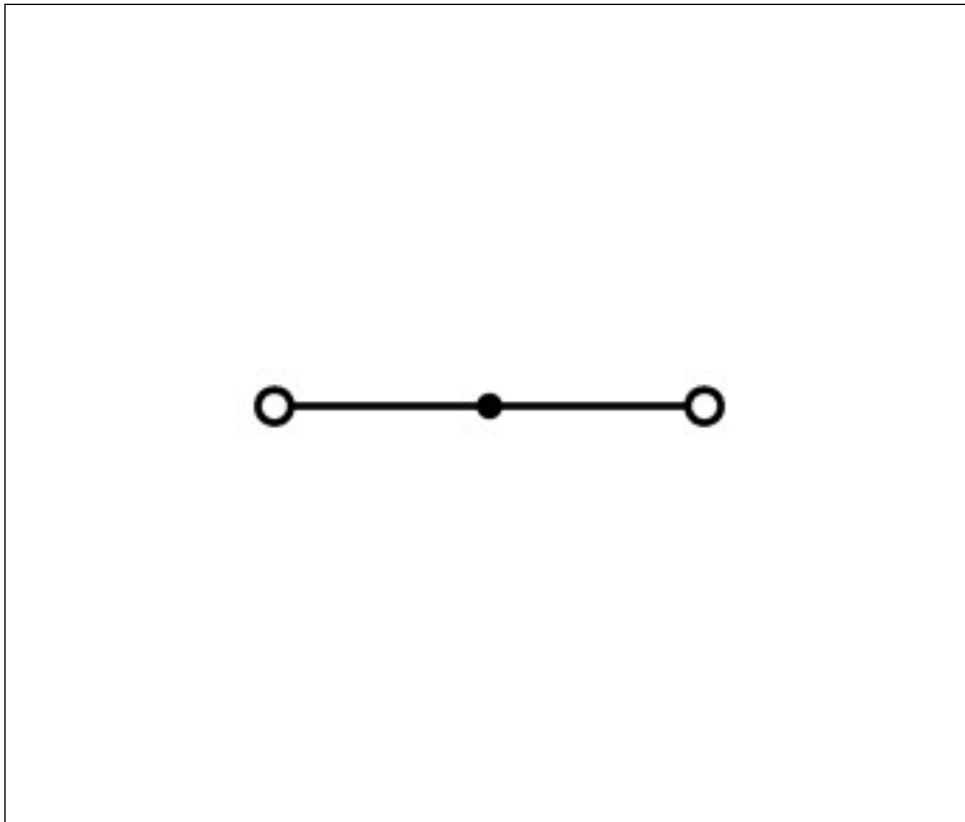

#### Address

WAGO Kontakttechnik GmbH & Co. KG

Hansastr. 27

32423 Minden

Telefon: 0571/887-0

Fax: 0571/887-169

<http://www.wago.com>

© WAGO Kontakttechnik GmbH & Co. KG

Technische Änderungen und Irrtümer vorbehalten.