

EVC130

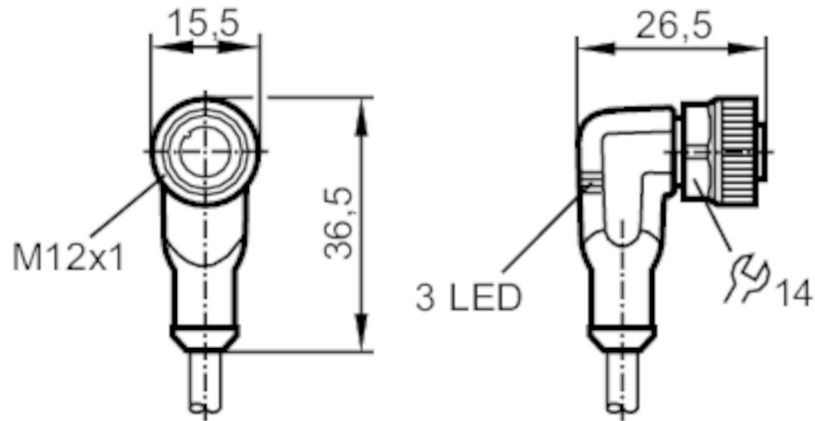

Connecting cable with socket

ADOAH043MSS0020H04



Application

Special feature	Free from silicone; Halogen-free; Gold-plated contacts; Drag chain suitability
Free from silicone	yes

Electrical data

Operating voltage	[V]	10...36 DC
Protection class		II
Max. current load total	[A]	4

Outputs

Electrical design	PNP
-------------------	-----

Operating conditions

Ambient temperature	[°C]	-25...90
Note on ambient temperature		cULus: ...75
Ambient temperature (moving)	[°C]	-25...90
Note on ambient temperature (moving)		cULus: ...75
Protection		IP 65; IP 67; IP 68; IP 69K

Tests / approvals

MTTF	[years]	20027
------	---------	-------

EVC130



Connecting cable with socket

ADOAH043MSS0020H04

Mechanical data		
Weight [g]	568.7	
Dimensions [mm]	26.5 x 15.5 x 36.5	
Materials	housing: TPU black transparent; Sealing: FKM	
Material nut	brass, nickel-plated	
Drag chain suitability	yes	
Drag chain suitability	bending radius for flexible use	min. 10 x cable diameter
	travel speed	max. 3.3 m/s for a horizontal travel length of 5 m and max. acceleration of 5 m/s ²
	bending cycles	> 5 Mio.
	torsional strain	± 180 °/m

Displays / operating elements		
Display	switching status	2 x LED, yellow
	operation	1 x LED, green

Remarks	
Notes	Please see the technical note under "Downloads"
Pack quantity	1 pcs.

Electrical connection
Cable: 20 m, PUR, Halogen-free, black, Ø 4.3 mm; 4 x 0.34 mm² (42 x Ø 0.1 mm)

Electrical connection - socket
Connector: 1 x M12, angled; Locking: brass, nickel-plated; Contacts: gold-plated; Tightening torque: 0.6...1.5 Nm

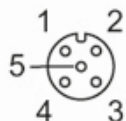

EVC130



Connecting cable with socket

ADOAH043MSS0020H04

Connection



Core colours :

BK =	black
BN =	brown
BU =	blue
WH =	white