



CIRCUIT BREAKER 400V 15KA, 4-POLE, D, 2A, D=70MM

Model		
product brand name		SENTRON
Product designation		5SY miniature circuit breaker
Design of the product		5SY miniature circuit breakers
General technical data		
Number of poles		4
Number of poles / Note		4P
Tripping characteristic class		D
circuit-breaker / Design		5SY7
Mechanical service life (switching cycles) / typical		20 000
Overvoltage category		3
Voltage		
Insulation voltage		
<ul style="list-style-type: none"> with multi-phase operation / with AC / Rated value 	V	440
Supply voltage		
Supply voltage frequency / Rated value	Hz	50
Protection class		
Protection class IP		IP20, with connected conductors
Energy limiting class		3
Switching capacity		
Switching capacity current		
<ul style="list-style-type: none"> for DC / acc. to IEC 60947-2 / Rated value 	kA	15

- acc. to EN 60898 / Rated value
- acc. to IEC 60947-2 / Rated value

kA	15
kA	50

Dissipation

Active power loss

- for rated value of the current / with AC / in hot operating state / per pole

W	1.2
---	-----

Electricity

rated current I_n / IEC, DIN/VDE / at 40 Cel

A	1.9
---	-----

Current / with AC / Rated value

A	2
---	---

Product details

Product feature / Touch protection

	Yes
--	-----

Product component

- combined terminal top
- combined terminal bottom

	Yes
	Yes

Product property

- Properties for main switches in accordance with EN 60204-1
- halogen-free
- sealable
- silicon-free

	Yes
	Yes
	Yes
	Yes

Product expansion / can be installed / supplementary devices

	Yes
--	-----

Product function

Product function / neutral conductor switching

	No
--	----

Short circuit

Breaking capacity short-circuit current (I_{cn})

- with AC / acc. to UL 1077 and CSA C22.2 No.235
- for DC / acc. to EN 60898-2

kA	5
kA	15

Number

Number of test cycles / for environmental testing / acc. to IEC 60068-2-30

	6
--	---

Connections

Connectable conductor cross-section / stranded

- minimum
- maximum

mm ²	0.75
mm ²	35

Connectable conductor cross-section

- solid
 - minimum
 - maximum

mm ²	0.75
mm ²	35

<ul style="list-style-type: none"> • finely stranded / with core end processing <ul style="list-style-type: none"> — minimum — maximum 	mm ²	0.75
	mm ²	25
AWG number / as coded connectable conductor cross section		
<ul style="list-style-type: none"> • minimum • maximum 		14
		4
Tightening torque [lbf·in] / with screw-type terminals		
<ul style="list-style-type: none"> • minimum • maximum 	lbf·in	22
	lbf·in	26
Tightening torque / with screw-type terminals		
<ul style="list-style-type: none"> • minimum • maximum 	N·m	2.5
	N·m	3
Position / of power supply cord		Any

Mechanical Design

Height	mm	90
Width	mm	72
Depth	mm	76
mounting position		any
Installation depth	mm	70
Number of width units		4
Mounting type		Quick assembly system

Environmental conditions

Influence of the surrounding temperature		Max. 95% humidity
Shock resistance / acc. to IEC 60068-2-27		150m/s ² at 11ms half-sine
Vibration resistance / acc. to IEC 60068-2-6		50m/s ² at 25 to 150Hz and 60m/s ² at 35Hz (4sec)
Ambient temperature		
<ul style="list-style-type: none"> • minimum • maximum • during storage / minimum • during storage / maximum 	°C	-25
	°C	55
	°C	-40
	°C	75

Certificates

Equipment marking / acc. to DIN EN 61346-2		F
--	--	---

General Product Approval



Declaration of
Conformity

Shipping Approval

other



[other](#)

Further information

Information- and Downloadcenter (Catalogs, Brochures,...)

<http://www.siemens.com/lowvoltage/catalogs>

Industry Mall (Online ordering system)

<https://eb.automation.siemens.com/mall/en/WW/Catalog/Product/5SY74028>

Service&Support (Manuals, Certificates, Characteristics, FAQs,...)

<http://support.automation.siemens.com/WW/view/en/5SY74028/all>

Image database (product images, 2D dimension drawings, 3D models, device circuit diagrams, ...)

http://www.automation.siemens.com/bilddb/cax_en.aspx?mlfb=5SY74028

CAx-Online-Generator

<http://www.siemens.com/cax>

Tender specifications

<http://ausschreibungstexte.siemens.com/tiplv>

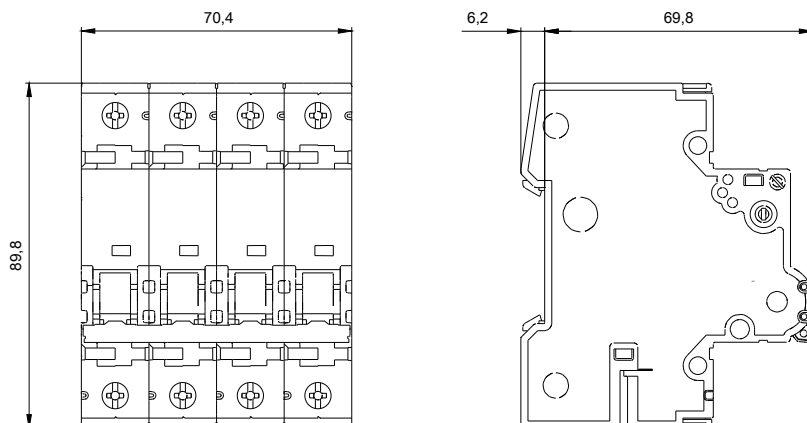

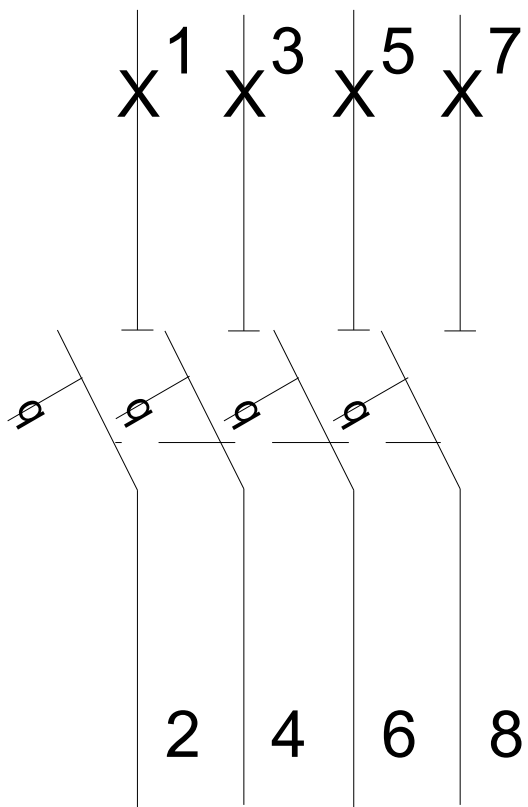

last modified:

11.03.2015