

HOUSING	OPERATING DISTANCE	MOUNTING	✓ Long operating distance	✓ IP67
M8	4 mm	Embeddable	✓ Exceptional price-performance ratio	✓ IO-Link v1.1
			✓ Excellent accuracy	

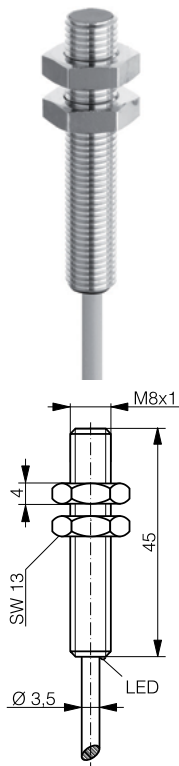

DW-AD-52x-M8

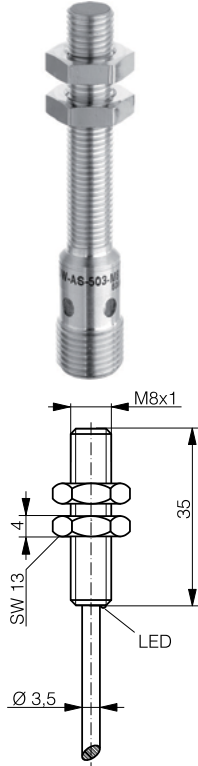

DW-AD-52x-M8-750

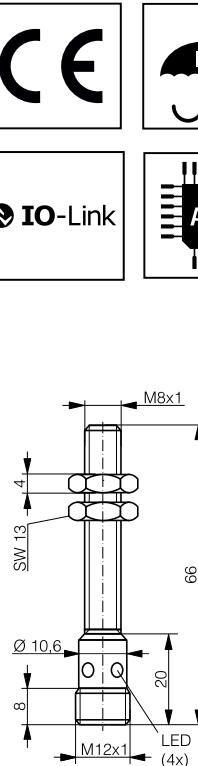

DW-AS-52x-M8

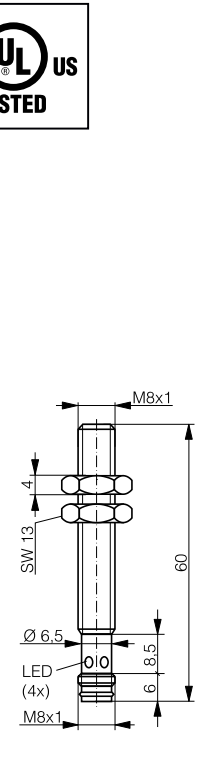

DW-AS-52x-M8-001

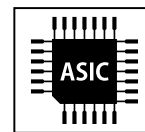

DETECTION DATA		INTERFACE	
Rated operating distance (S_n)	4 mm	Indicator LED, yellow	Sensing state ($0 \leq s \leq 0.8 S_r$)
Assured operating distance (S_a)	$\leq (0.81 \times S_n)$ mm	Indicator LED, yellow, blinking	Sensing state ($0.8 S_r < s \leq S_r$)
Repeat accuracy	≤ 0.2 mm	IO-Link	✓
Hysteresis	$3\% S_r < \text{Hyst} \leq 15\% S_r$	MTTF (@40°C)	1073 y
Temperature drift	$\leq 10\% S_r$		
Standard target	12 x 12 x 1 mm ³ , FE360		

Note: $0.9S_n \leq S_a \leq 1.1S_n$.

ELECTRICAL DATA		MECHANICAL DATA	
Supply voltage range (U_B)	10...30 VDC	Mounting	Embeddable
Residual ripple	$\leq 20\% U_B$	Housing material	Chrome-plated nickel silver
Output current	≤ 200 mA	Sensing face material	PBTP
Output voltage drop	≤ 2.0 VDC	Max tightening torque	8 Nm (2.5 Nm first 7 mm)
Power consumption (no-load)	≤ 10 mA	Ambient operating temperature	-25...+70°C ¹
Residual current	≤ 0.1 mA	Enclosure rating	IP 67
Switching frequency	≤ 500 Hz	Weight (cable / connector)	see page 2
Short-circuit protection	✓	Shock and vibration	IEC 60947-5-2 / 7.4
Voltage reversal protection	✓		
Cable length max.	≤ 300 m		

¹Maximum temperature according to UL: 70°C.

Note: all data measured according to IEC 60947-5-2 standard with $U_B=20 \dots 30$ VDC, $T_A=23^\circ\text{C} \pm 5^\circ\text{C}$.

CORRECTION FACTORS

Steel FE 360	1	Copper	0.22	Aluminum	0.25	Brass	0.33	Stainless S. V2A 1 / 2 mm	0.63
--------------	---	--------	------	----------	------	-------	------	---------------------------	------

Note: the operating distance of the sensor must be multiplied by the correction factor of the material. For example, the operating distance on Aluminum is $S_{n,Al} = S_n \times CF_{Al}$. In case of embeddable mounting, the distance is multiplied by the additional correction factor of the support, thus $S_{n,Al} = S_n \times CF_{Al} \times CF_{emb,Al}$.

INSTALLATION CONDITIONS

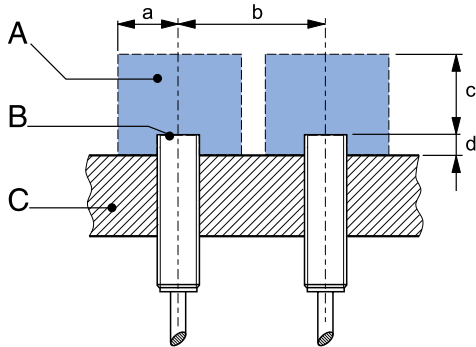

A : metal free zone a : 8 mm d : steel 0 mm
 B : sensing face b : 20 mm
 C : support c : 12 mm

Note: additional installation information can be found in the glossary of the Contrinex General Catalog.

IO-LINK FUNCTIONALITIES

IO-Link version	1.1
SIO mode	Supported
Process data	7-bit input
Baudrate	COM2 (38.4 kBaud)
Minimum cycle time	10.4 ms
ISDU	Not supported



IO-Link files may be downloaded from

www.contrinex.com/product-range/inductive-sensors/.

Select the product name to display the product page with corresponding downloads.

Alternatively, just click/scan the QR code on the left.

WIRING DIAGRAM

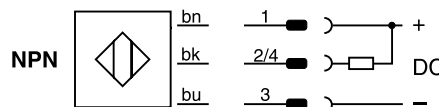
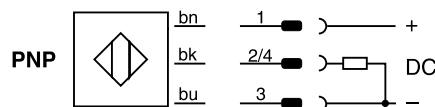

PIN ASSIGNMENT

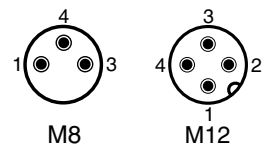

AVAILABLE TYPES

Part number	Part reference	Polarity	Connection	Output on pin 2	Output on pin 4 / bk	Weight
330-020-034	DW-AD-521-M8	NPN	PVC, 2 m, 3 wire	-	Normally open (NO)	45 g
330-020-035	DW-AD-522-M8	NPN	PVC, 2 m, 3 wire	-	Normally close (NC)	45 g
330-020-042	DW-AD-523-M8	PNP	PVC, 2 m, 3 wire	-	Normally open (NO) / IO-Link	45 g
330-020-046	DW-AD-524-M8	PNP	PVC, 2 m, 3 wire	-	Normally close (NC)	45 g
330-020-057	DW-AD-521-M8-750	NPN	PVC, 2 m, 3 wire	-	Normally open (NO)	42 g
330-020-059	DW-AD-523-M8-750	PNP	PVC, 2 m, 3 wire	-	Normally open (NO) / IO-Link	42 g
330-020-060	DW-AD-524-M8-750	PNP	PVC, 2 m, 3 wire	-	Normally close (NC)	42 g
330-020-068	DW-AS-521-M8	NPN	M12 4-pin	-	Normally open (NO)	20 g
330-020-069	DW-AS-521-M8-001	NPN	M8 3-pin	-	Normally open (NO)	17 g
330-020-070	DW-AS-522-M8	NPN	M12 4-pin	Normally close (NC)	-	20 g
330-020-071	DW-AS-522-M8-001	NPN	M8 3-pin	-	Normally close (NC)	17 g
330-020-076	DW-AS-523-M8	PNP	M12 4-pin	-	Normally open (NO) / IO-Link	20 g
330-020-077	DW-AS-523-M8-001	PNP	M8 3-pin	-	Normally open (NO) / IO-Link	17 g
330-020-078	DW-AS-524-M8	PNP	M12 4-pin	Normally close (NC)	-	20 g
330-020-079	DW-AS-524-M8-001	PNP	M8 3-pin	-	Normally close (NC)	17 g

Note: part reference may include additional suffix to indicate a revision version or special version. Further information is available on request.

Operators of the products we supply are responsible for compliance with measures for the protection of persons. The use of our equipment in applications where the safety of persons might be at risk is only authorized if the operator observes and implements separate, appropriate and necessary measures for the protection of persons and machines. Terms of delivery and rights to change design reserved.