

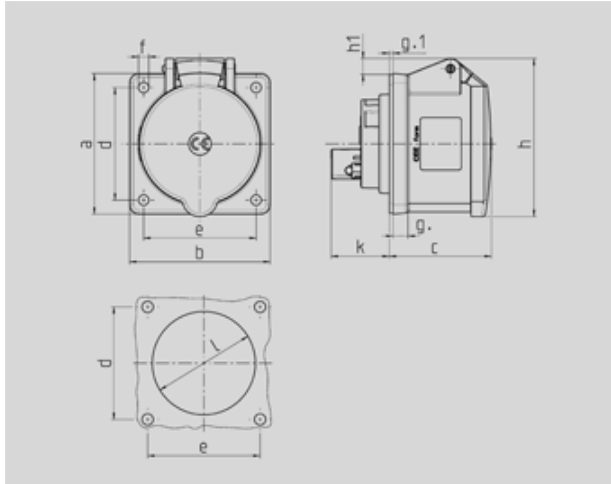

Bestell-Nr. : 1276

Anbausteckdose

mit Schraubkontakt, gerade Steckrichtung, Flansch: 75 x 75 mm, Bohrlochabstand: 60 x 60 mm



Zeichnung 1 MB 360	Amp. Pole	16			32		
		3	4	5	3	4	5
Maße in mm	a	75	75	75	75	75	75
	b	75	75	75	75	75	75
	c	53	53	55	64	64	64
	d	60	60	60	60	60	60
	e	60	60	60	60	60	60
	f	5,5	5,5	5,5	5,5	5,5	5,5
	g.	8	8	8	8	8	8
	g.1	2	2	2	2	2	2
	h	75	80	85	89	89	95
	h1		6	9	11	11	12
	k	31	32	32	39	39	17
	l	43	52	54	58	58	54
Klemmen für Leiterquerschnitt von bis mm ²		1,5	1,5	1,5	2,5	2,5	2,5
		-4	-4	-4	-10	-10	-10

Artikel-Gruppe : 1056

Spannung : 400V

Stromstärke : 32A

Polzahl : 5 polig







Schutzart : IP 44

Uhrzeit : 6h

Verpackungseinheit : 0010

Gewicht : 225 g

BESTELLNUMMERN

V	110V	230V	400V	500V	>50-500V	
Hz	50,60	50,60	50,60	50,60	100-300	300-500
Kennfarbe						
Amp.						
32 A	5	1274	1275	<u>1276</u>	3069	3089
					3090	