

22117-352 EURORACK 19" PANEL/SLIDE MOUNT, 20 U, ALZN

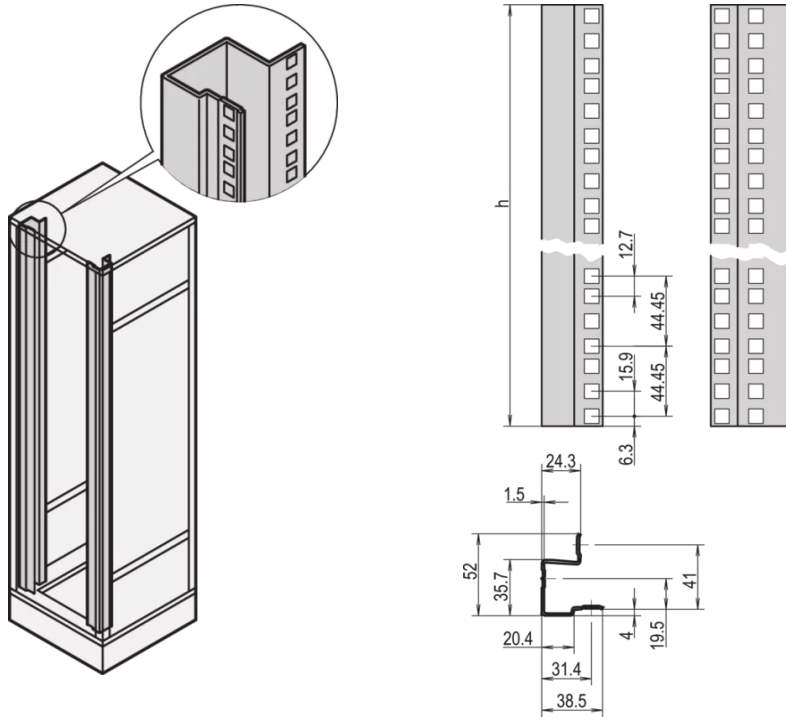

**KEY FEATURES**

For depth-adjustable mounting

St, 1.5 mm, with EIA cut-out

For the assembly of a third 19" plane 1-pair of 19" panel/slide mounts and 2-pairs-of depth members are needed

**PRODUCT ATTRIBUTES**

Product Type: Slide Mount

Product Family: Eurorack

Type: 19" Panel Slide Mount

Finish: Aluminum-Zinc Plated

Rack Height: 20 U

Height: 998 mm

## ADDITIONAL PRODUCT DETAILS

---

Slide mount with adjustable increments.

## CERTIFICATIONS

---



### North America

All locations  
+1.763.422.2661  
Chat with us:  
[schroff.nvent.com](https://schroff.nvent.com)

### Europe

Straubenhardt, Germany  
+49.7082.794.0  
Betschdorf, France  
+33.3.88.90.64.90  
Warsaw, Poland  
+48.22.209.98.35  
Assago, Italy  
+39.02.932.7141  
Chat with us:  
[schroff.nvent.com](https://schroff.nvent.com)

### Asia

Shanghai, China  
+86.21.2412.6943  
Qingdao, China  
+86.532.8771.6101  
Singapore  
+65.6768.5800  
Shin-Yokohama, Japan  
+81.45.476.0271  
Chat with us:  
[schroff.nvent.com](https://schroff.nvent.com)

### Middle East & India

Dubai, United Arab Emirates  
+971.4.378.1700  
Bangalore, India  
+91.80.6715.2001  
Istanbul, Turkey  
+90.216.250.7374  
Chat with us:  
[schroff.nvent.com](https://schroff.nvent.com)



Our powerful portfolio of brands:  
[nVent.com](https://nVent.com) **CADDY ERICO HOFFMAN RAYCHEM SCHROFF TRACER**

© 2023 nVent. All nVent marks and logos are owned or licensed by nVent Services GmbH or its affiliates. All other trademarks are the property of their respective owners.

nVent reserves the right to change specifications without notice.