

EVC119

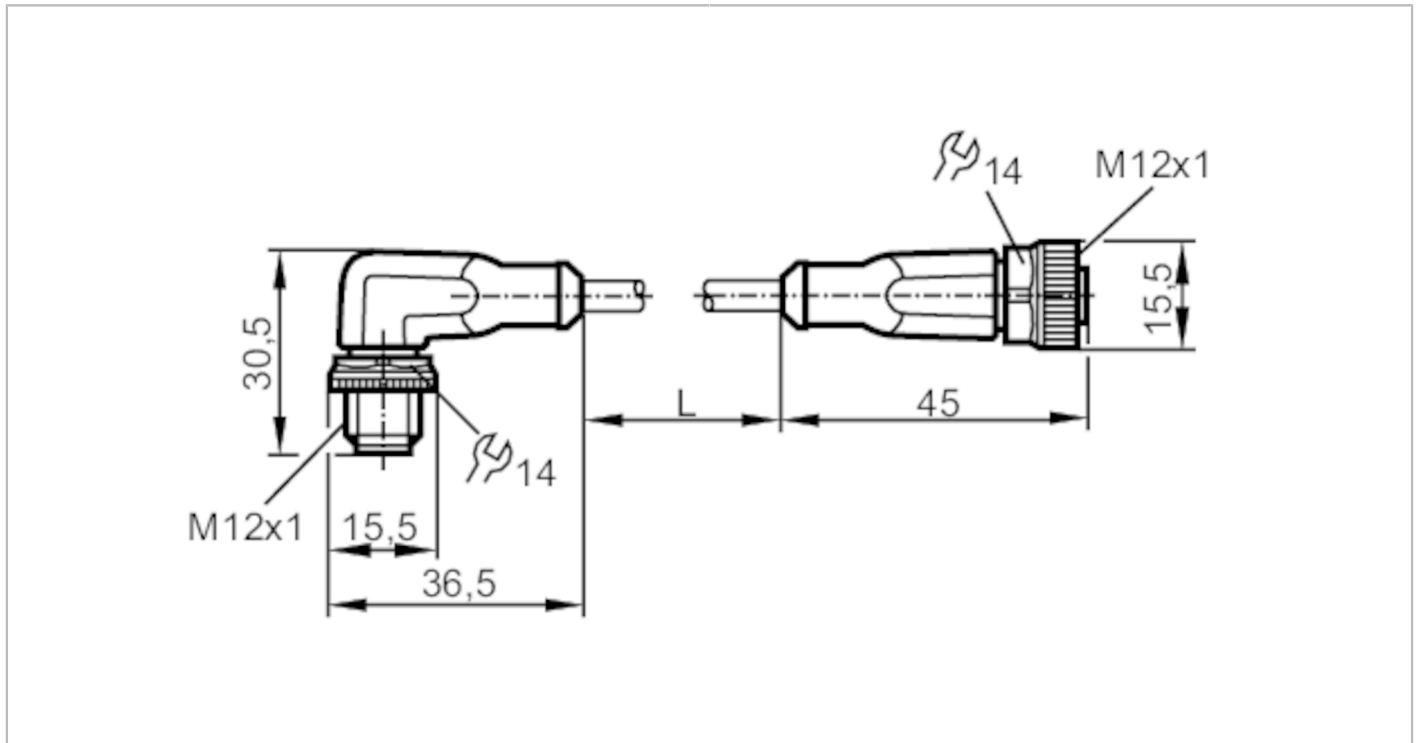

Connection cable

VDOGH040MSS00,7H04STAH040MSS



| Application | |
|--------------------------------------|--|
| Special feature | Free from silicone; Halogen-free; Gold-plated contacts; Drag chain suitability |
| Free from silicone | yes |
| Electrical data | |
| Operating voltage [V] | < 250 AC / < 300 DC |
| Protection class | II |
| Max. current load total [A] | 4 |
| Operating conditions | |
| Ambient temperature [°C] | -25...90 |
| Note on ambient temperature | cULus: ...75 |
| Ambient temperature (moving) [°C] | -25...90 |
| Note on ambient temperature (moving) | cULus: ...75 |
| Protection | IP 65; IP 67; IP 68; IP 69K |

EVC119



Connection cable

VDOGH040MSS00,7H04STAH040MSS

| Mechanical data | | |
|------------------------|---|--|
| Weight [g] | 59.2 | |
| Dimensions [mm] | 30.5 x 15.5 x 36.5 | |
| Materials | housing: TPU orange; Sealing: FKM | |
| Material nut | brass, nickel-plated / brass, nickel-plated | |
| Drag chain suitability | yes | |
| Drag chain suitability | bending radius for flexible use | min. 10 x cable diameter |
| | travel speed | max. 3.3 m/s for a horizontal travel length of 5 m and max. acceleration of 5 m/s ² |
| | bending cycles | > 5 Mio. |
| | torsional strain | ± 180 °/m |

| Remarks | |
|---------------|---|
| Notes | Please see the technical note under "Downloads" |
| Pack quantity | 1 pcs. |

Electrical connection - plug

Connector: 1 x M12, angled; Locking: brass, nickel-plated; Contacts: gold-plated; Tightening torque: 0.6...1.5 Nm



Electrical connection

Cable: 0.7 m, PUR, Halogen-free, black, Ø 4.3 mm; 4 x 0.34 mm² (42 x Ø 0.1 mm)

Connection

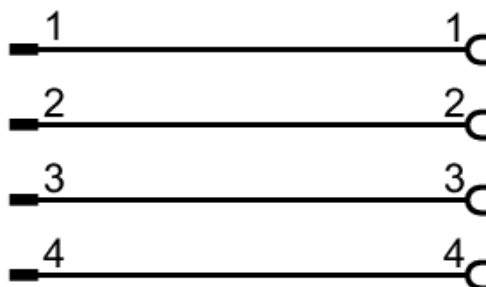

Electrical connection - socket

Connector: 1 x M12, straight; Locking: brass, nickel-plated; Contacts: gold-plated; Tightening torque: 0.6...1.5 Nm

EVC119



Connection cable

VDOGH040MSS00,7H04STAH040MSS



Diagrams and graphs

characteristic line for derating



Derating $I_{max} * 0.8$ (DIN EN 60512-5-2)

X Ambient temperature [°C]

Y Current [A]