

MET 1-PHASE CONTROL AND ISOLATION TRANSFORMER

P: 5000VA IN: 400VAC+/- 5% OUT: 230VAC

Single-phase - Control and Isolation Transformers
 5000 VA
 Spring clamp terminals
 Isolation class T 40/B

[Link to Product](#)

Illustration

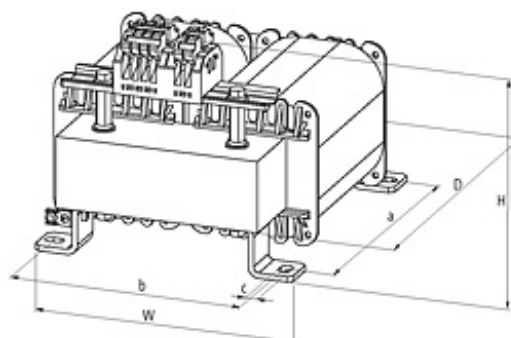
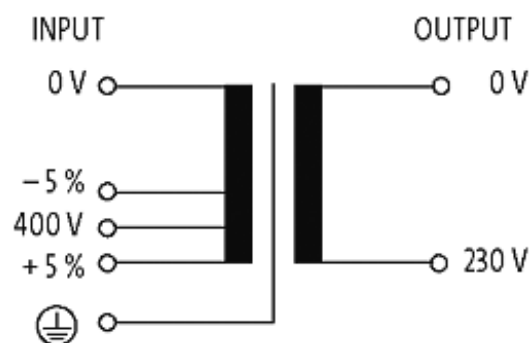

Product may differ from Image

Approvals



Input

Input voltage	400 V AC \pm 5 %
Frequency	50...60 Hz
Input current	12.86 A (400 V AC)
Short-circuit current	700.3 A (400 V AC)
Inrush current	254.2 A (400 V AC)

General data

Standards	(EN 61558-1), (EN 61558-2-4), (EN 62041 category 0)
Test isolation voltage	4 kV (prim./sec.)
Dimensions H x W x D	225x198x250 mm
Fixing centers a x b x c	200x174x9 mm
Drill hole \emptyset	9x14 mm
Mounting method	Long-hole mounting
Temperature range	-20...+40 °C, no condensation

Output

Output voltage	230 V AC
----------------	----------

Commercial data

country of origin	CZ
customs tariff number	85043200
minimum order quantity	1