

## MPL POWER SUPPLY 3-PHASE, SMOOTHED

IN: 400VAC+/- 5% OUT: 24V/60ADC

Current: 60 A

Output rating: 1440 W

### [Link to Product](#)

#### Illustration

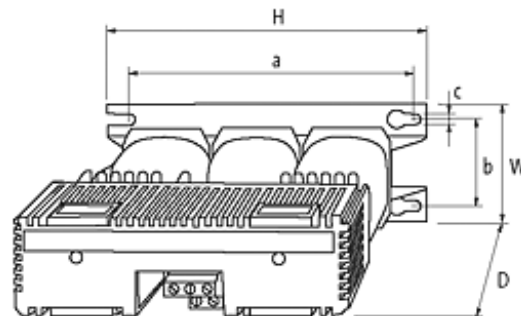
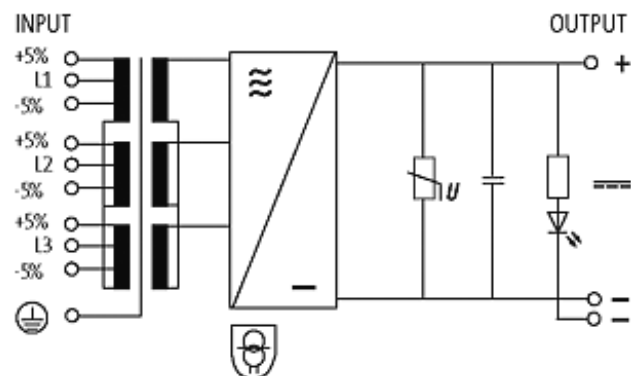

Product may differ from Image

#### Approvals

The information in this brochure has been compiled with the utmost care.

Liability for the correctness completeness and topicality of the information is restricted to gross negligence. Version: 05/15

Murrelektronik GmbH | Falkenstraße 3, 71570 Oppenweiler | Fon +49 (71 91) 47-0, Fax +49 (71 91) 47-491000 | shop@murrelektronik.de | shop.murrelektronik.de



### Input

Input voltage	3 × 400 V AC ±5 %
Input current	3.1 A (3 × 400 V AC)
Input fuse (external)	4 A (T)
Frequency	50...60 Hz

### General data

Standards	(EN 61558-2-6), (EN 62041 category I), (EN 55011 B), (EN 61000-3-2)
Temperature range	-20...+55 °C, for any mounting position at vertical wall, no condensation
Mounting method	Key-hole mounting
Efficiency	78 %
Dimensions H × W × D	280×154×313 mm
Fixing centers a × b × c	256.5×128×11 mm

### Output

Output voltage	24 V DC (SELV)
Output current	max. 60 A
Ripple	max. 2 %rms
Output fuse external	60 A (T)
Output filter	LED, VDR and smoothing capacitor

### Commercial data

country of origin	CZ
customs tariff number	85044090
minimum order quantity	1