

PRODUKTDATENBLATT

POLO-KAL NG Abzweig 50/40/45

Artikel-Nr. 02212

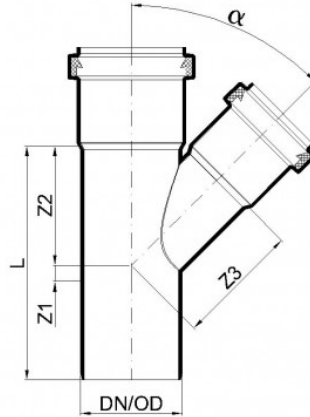
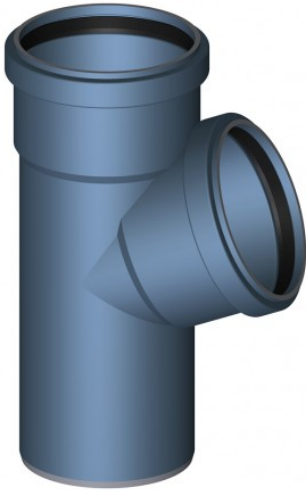

PURE
PROGRESS / poloplast

Technische Daten

DN/OD	50
DN/OD2	40
Winkel α	45°
Länge L	115 mm
Z1	8 mm
Z2	59 mm
Z3	61 mm
Gewicht	0,10 kg/Stk.
Verpackungseinheit	10 Stk.