

Actuator/sensor cable, PUR extension cable
PKW3M-0,6-RSC4T/TXL

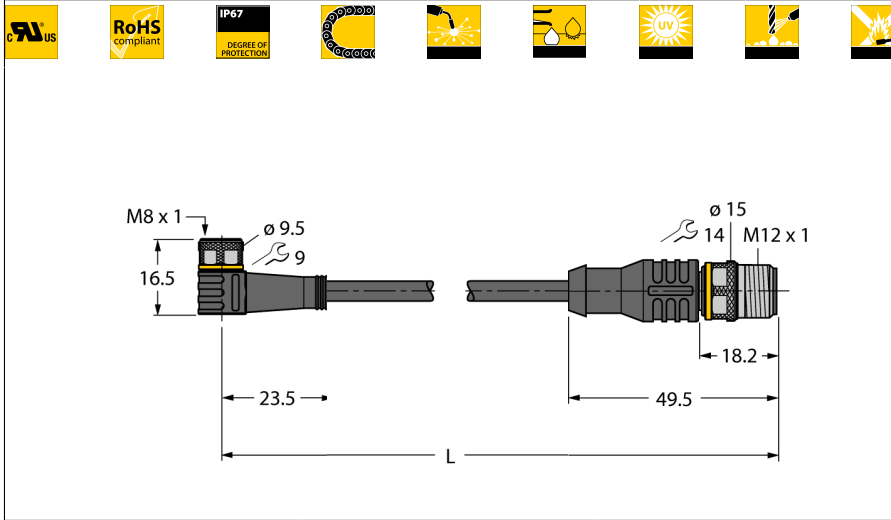

- Female M8, angled, 3-pin
- Male M12, straight, 3-pin
- Sheath material: PUR
- Sheath color: black
- Qualified for drag chain use
- Resistant to weld splatter
- Resistant to chemicals, UV radiation and oils
- Flame retardant
- Free from halogen, silicone, PVC and LABS
- Particularly resistant to abrasion
- Approval: cULus
- RoHS conform
- Protection class IP67
- Cable length: 0.6 m

Type designation PKW3M-0,6-RSC4T/TXL
Ident no. 6627104

Connector A side
 Number of pins Female connector, M8 ⤵ 1, Angled 3
 Contacts Brass, CuZn, Gold-plated
 Contact carriers Plastic, TPU, Black
 Grip Plastic, TPU, Black
 Coupling nut/screw Brass, CuZn, Nickel-plated
 Seal Plastic, FPM/FKM
 Protection class IP67, A + B side screwed together
 Mechanical lifespan > 100 Mating cycles
 Pollution degree 3
 Tightening torque 0.5 ... 0.6 Nm
 (observe max. torque of counter piece!)

Connector B side
 Number of pins Connector, M12 x 1, Straight 3 pins
 Contacts brass, CuZn, Gold-plated
 Contact carriers Plastic, TPU, Black
 Grip plastic, TPU, black
 Coupling nut/screw Brass, CuZn, Nickel-plated
 Protection class IP67, only in screwed state
 Mechanical lifespan > 100 Mating cycles
 Pollution degree 3
 Tightening torque 0.8 ... 1 Nm
 (observe max. torque of counter piece!)

General data
 Cable diameter 4.3 ± 0.20mm
 Cable length 0.6 m
 Cable quality PUR
 Cable color Black
 Core insulation PP
 Core colors BN, BU, BK
 Core cross-section 3x0.34mm²
 Arrangement of strands 42x0.1 mm

Electrical features at +20 °C
 Current 4 A
 Rated voltage 60 V
 Insulation resistance > 30.5 MΩ/km
 Test voltage 2000 V
 Forward resistance max. 57 Ω/km

Cable Cross-section

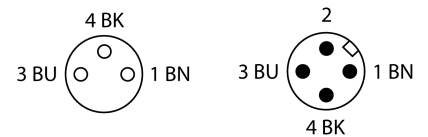
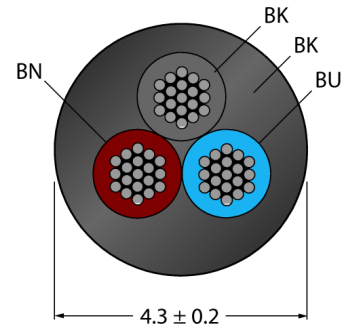

General information

Drawing shows design status including hexagon coupling nut
 (Start of production CW21/2016).

Circuit Diagram

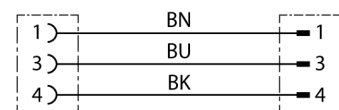

**Actuator/sensor cable, PUR
extension cable
PKW3M-0,6-RSC4T/TXL**

TURCK

Industrial
Automation

Mechanical and chemical properties

Max. tensile strength (static)	≤ 50 N/mm ²
Max. tensile strength (dynamic)	≤ 20 N/mm ²
Bending cycles	> 5 mil.
Bending radius (stationary laying)	> 5 x Ø
Bending radius (flexible use)	> 10 x Ø
Admissible acceleration	max. 5 m/s ²
Admissible travel path, horizontal	5 m (at 5 m/s ²)
Admissible travel path, vertical	2 m (at 5 m/s ²)
Admissible traversing speed	3.3 m/s
Torsional stress	± 180 °/m
Ambient temperature	
Stationary	-50...+80°C
In motion	-25...+80°C
Drag chain operation	-25...+60°C

**Actuator/sensor cable, PUR
extension cable
PKW3M-0,6-RSC4T/TXL**

TURCK

Industrial
Automation

Accessories

Type code	Ident no.	Description	
Torque-Wrench-Set-AS	6936170	Torque wrench set; handles with adjustable torque 0.4-1.0 Nm, torque wrench for M8 (SW9), fork wrench for M12 (SW 14)	
BLANK-LABEL-FOR-CORDESETS-TEL-TXL	6936206	Label for TEL and TXL cables, length: 18 mm, height: 4 mm, material: polycarbonate (PC), color: white, halogen-free and flame-retardant	