

TF-FUSE® Thin Film Surface Mount Fuses

FF Series (Very Fast Acting), 0603 Size

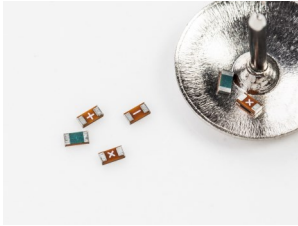

Features:

- Very fast acting at 200% overload current levels
- Low DCR
- High inrush current withstanding capability
- Fiberglass enforced epoxy fuse body
- Copper termination with nickel and tin plating
- Halogen free, RoHS compliance and lead-free

Applications:

- Notebook computers and tablets
- Digital cameras
- Memory cards
- Toys
- Bluetooth earphones
- Portable electronic devices

Shape and Dimensions:

Unit	Inch	mm
Length (L)	0.063 ± 0.004	1.60 ± 0.10
Width (W)	0.032 ± 0.004	0.81 ± 0.10
Thickness (T)	0.012 ± 0.004	0.30 ± 0.10
Termination bandwidth (b)	0.014 ± 0.004	0.36 ± 0.10

Clearing Time Characteristics:

% of Current Rating	Opening Time at 25°C
100%	4 hours min.
200%	5 seconds max.
300%	0.2 second max.

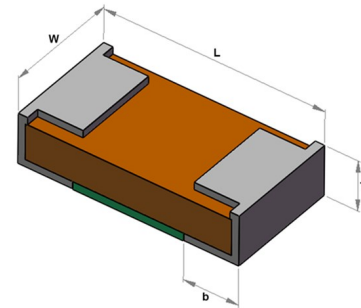

Agency Approval:

Recognized Under the Components Program of UL.
File Number: E232989.

Typical Ratings and Characteristics:

Operating temperature: -55 to +90°C

Part Number	Current Rating (A)	Voltage Rating (VDC)	Interrupting Rating	Nominal Cold DCR (Ω) ¹	Nominal I^2t (A ² s) ²	Marking
T0603FF0150TM	0.15	65	50A@35V DC/AC 13A@65V DC	2.2	0.0006	·
T0603FF0200TM	0.2	65		1.3	0.0014	..
T0603FF0250TM	0.25	65		1.1	0.0016	:
T0603FF0375TM	0.375	65		0.48	0.004	...
T0603FF0500TM	0.5	65		0.185	0.012	I
T0603FF0750TM	0.75	65		0.112	0.021	-
T0603FF1000TM	1	65		0.069	0.042	+
T0603FF1250TM	1.25	65	35A@35V DC/AC 13A@65V DC	0.048	0.052	×
T0603FF1500TM	1.5	65		0.037	0.071	
T0603FF1750TM	1.75	35	35A@35V DC/AC 50A@24V DC/AC	0.031	0.1	
T0603FF2000TM	2	35		0.026	0.14	=
T0603FF2500TM	2.5	35		0.021	0.24	H
T0603FF3000TM	3	35		0.0176	0.33	III
T0603FF3500TM	3.5	35		0.0148	0.49	HH
T0603FF4000TM	4	35		0.0125	0.63	□
T0603FF5000TM	5	35		0.0095	1.1	○

¹ Measured at $\leq 10\%$ of rated current and 25°C ambient. ² Melting I^2t at 0.001 sec.

TF-FUSE® Thin Film Surface Mount Fuses

FF Series (Very Fast Acting), 0603 Size

Average Pre-arcing Time Curves:

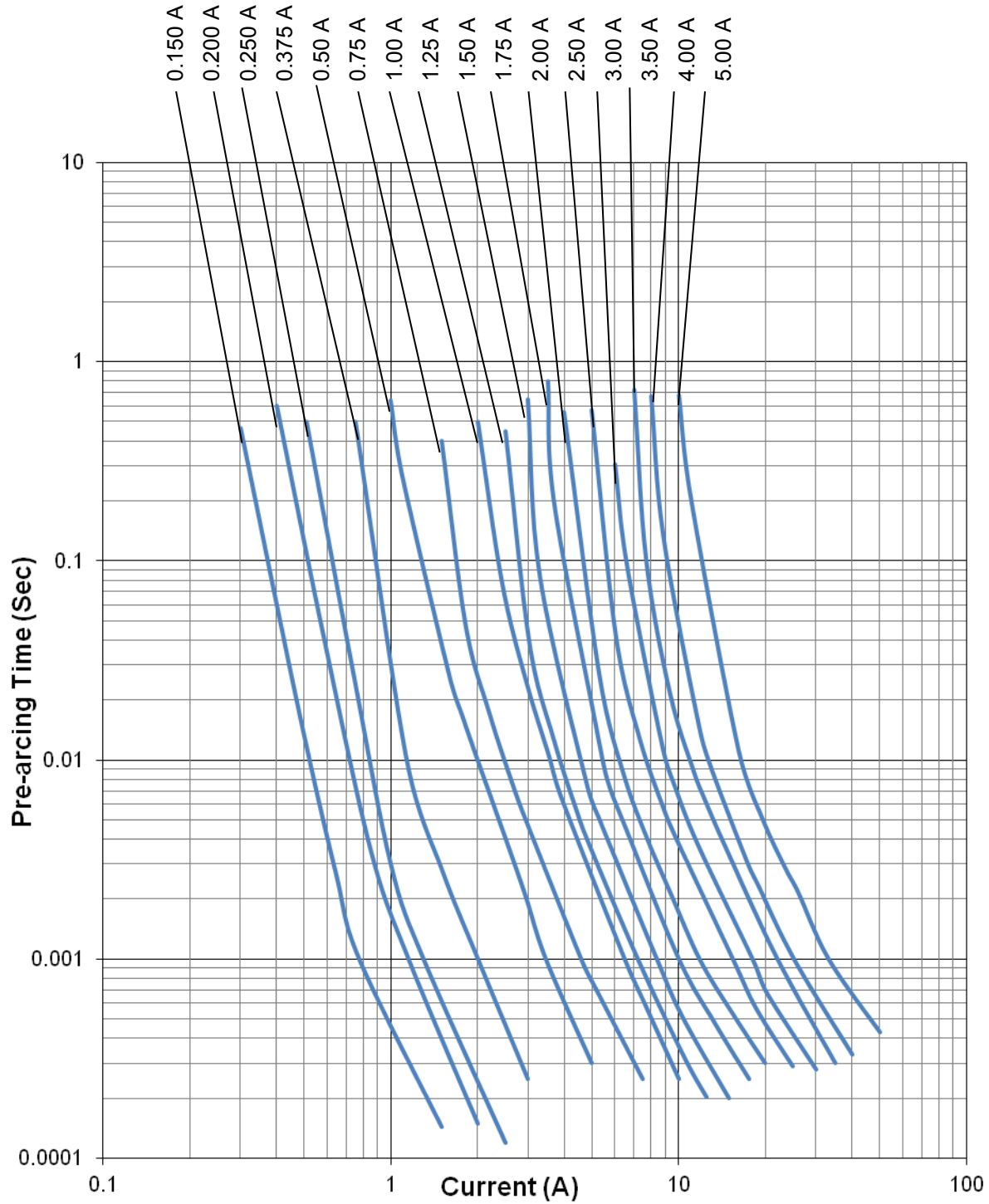

TF-FUSE® Thin Film Surface Mount Fuses

FF Series (Very Fast Acting), 0603 Size

Average I^2t vs. t Curves:

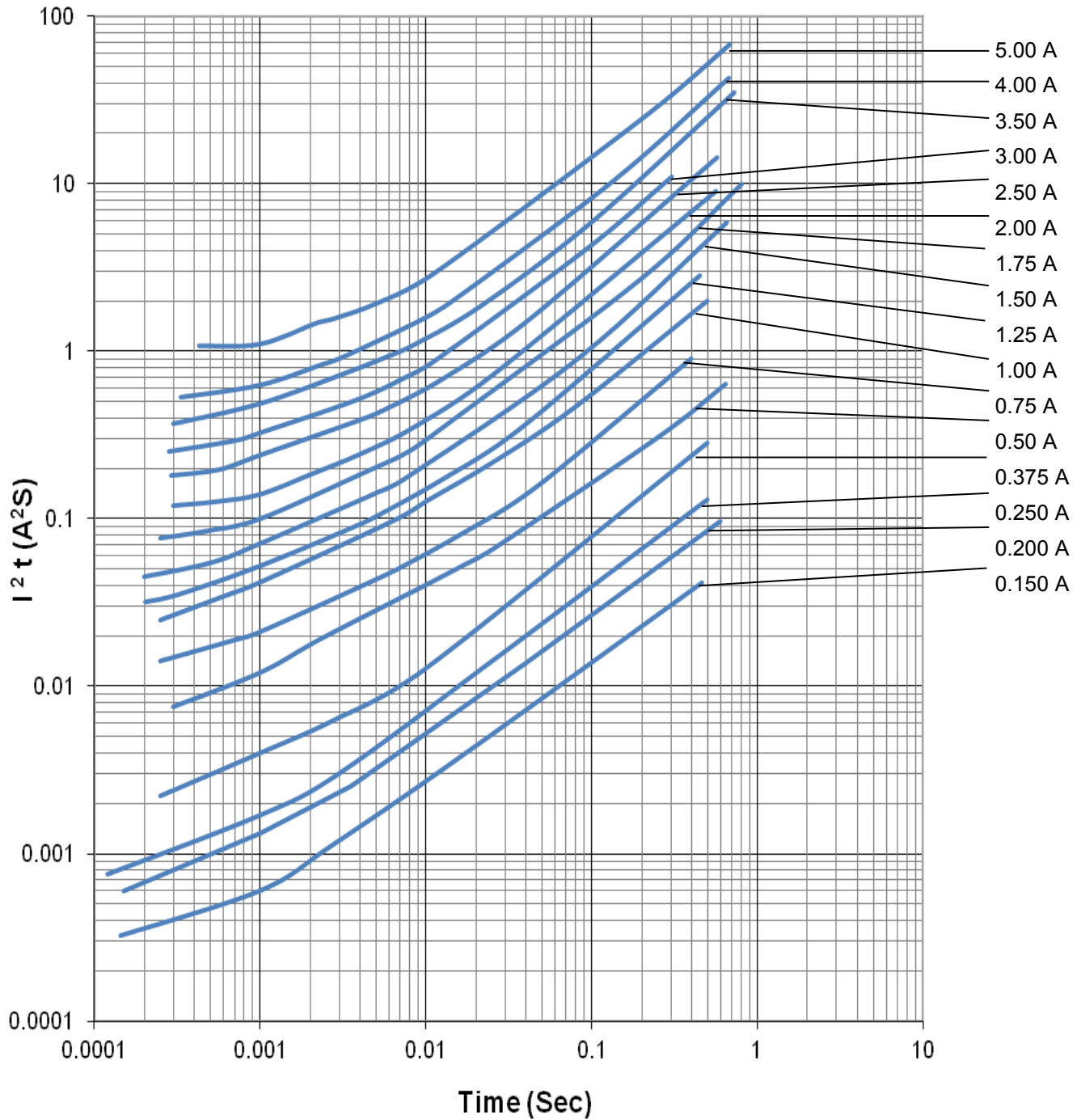

TF-FUSE® Thin Film Surface Mount Fuses

Product Identification:

T 0603 FF 1000 T M

(1) (2) (3) (4) (5) (6)

- (1) **Product Code:** T—Thin Film
- (2) **Size Code:** Standard EIA chip sizes
- (3) **Series Code:** FF—Very Fast Acting, HI—High Inrush
- (4) **Current Rating Code:** 0500—0.5A, 1000—1.0A
- (5) **Package Code:** T—Tape & Reel; B—Bulk

Environmental Tests:

No.	Test item	Requirement	Test condition	Reference
1	Bending	≤1A: 10% DCR change max. >1A: 20% DCR change max.	2mm	Refer to AEM QIQ034
2	Solderability	95% coverage min.	One dip at 255°C for 5 seconds	MIL-STD-202 Method 208
3	Thermal shock	DCR change within ±10% No mechanical damage	100 cycles between -55°C and +125°C	MIL-STD-202 Method 107
4	Moisture resistance	DCR change within ±10% No excessive corrosion	10 cycles	MIL-STD-202 Method 106
5	Salt spray	DCR change within ≤ ±10% No excessive corrosion	5% salt solution, 48 hour exposure	MIL-STD-202 Method 101
6	Mechanical vibration	DCR change within ≤ ±10% No mechanical damage	0.4" D.A. or 30G between 5 and 3000 Hz	MIL-STD-202 Method 204
7	Mechanical shock	DCR change within ≤ ±10% No mechanical damage	1500G, 0.5 ms, half sine shocks	MIL-STD-202 Method 213
8	Life	Change of voltage drop within ±10%, no open circuit	75% rated current, 2000 hours, ambient temperature +20°C to 30°C	Refer to AEM QIQ106

Packaging:

Chip Size	Parts on 7 inch (178mm) Reel
0603(1608)	8,000
0402(1005)	20,000

TF-FUSE® Thin Film Surface Mount Fuses

Temperature Effect on Current Rating:

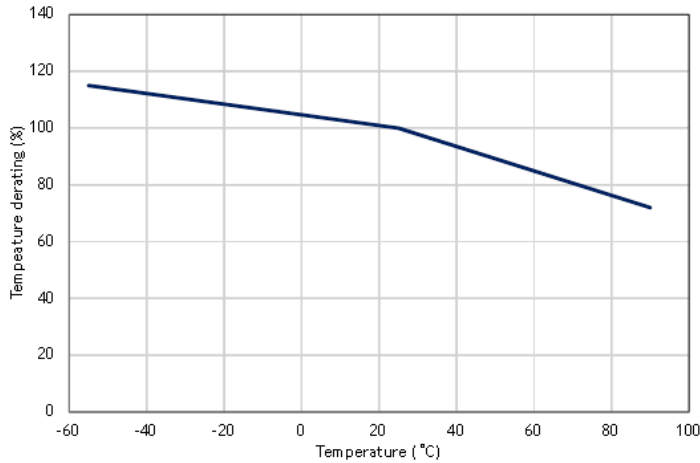

Recommended Reflow Soldering Profile:

Profile Feature	Pb-Free Assembly
Preheat/Soak	
Temperature Min (T_{smin})	150°C
Temperature Max (T_{smax})	200°C
Time (t_s) from (T_{smin} to T_{smax})	60~120 seconds
Ramp-up rate (T_L to T_p)	3°C/second max.
Liquidous temperature (T_L)	217°C
Time (t_L) maintained above T_L	60~150 seconds
Peak package body temperature (T_p)	260°C
Time (t_p)*within 5°C of the specified classification temperature (T_c)	30 seconds *
Ramp-down rate (T_p to T_L)	6°C/second max.
Time 25°C to peak temperature	8 minutes max.
* Tolerance for peak profile temperature (T_p) is defined as a supplier minimum and a user maximum	

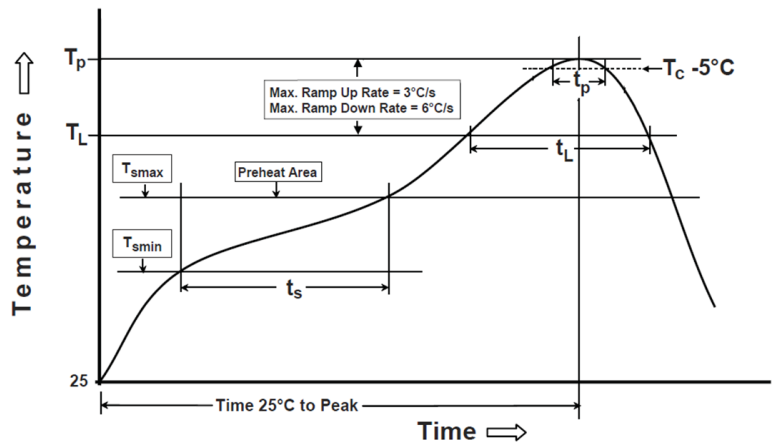

Thermal Shock When Making Correction with a Soldering Iron:

The temperature of soldering iron tip should be controlled under 350 °C and soldering time should be less than 3 sec. The soldering iron tip should not directly touch the top side termination of the component.

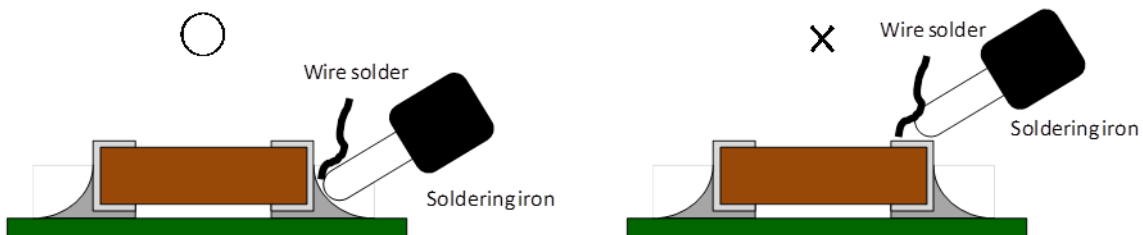

Fig 3 Correct handling method of soldering iron

Disclaimer

Specifications are subject to change without notice. AEM products are designed for specific applications and should not be used for any purpose (including, without limitation, automotive, aerospace, medical, life-saving applications, or any other application which requires especially high reliability for the prevention of such defect as may directly cause damage to the third party's life, body or property) not expressly set forth in applicable AEM product documentation. It is the customer's responsibility to validate that a particular product with the properties described in the product specification is suitable for use in a particular application. Warranties granted by AEM shall be deemed void for products used for any purpose not expressly set forth in applicable AEM product documentation. AEM shall not be liable for any claims or damages arising out of products used in applications not expressly intended by AEM as set forth in applicable AEM product documentation. The sale and use of AEM products is subject to AEM terms and conditions of sale. Please refer to AEM's website for updated catalog and terms and conditions of sale.