

Standard Recovery Diodes (Stud Version), 12 A



DO-203AA (DO-4)

FEATURES

- High surge current capability
- Stud cathode and stud anode version
- Wide current range
- Types up to 1200 V V_{RRM}
- RoHS compliant
- Designed and qualified for industrial and consumer level

RoHS
COMPLIANT

TYPICAL APPLICATIONS

- Battery charges
- Converters
- Power supplies
- Machine tool controls

PRODUCT SUMMARY

| | |
|-------------|------|
| $I_{F(AV)}$ | 12 A |
|-------------|------|

MAJOR RATINGS AND CHARACTERISTICS

| PARAMETER | TEST CONDITIONS | VALUES | UNITS |
|--------------|-----------------|-------------|------------------|
| $I_{F(AV)}$ | | 12 | A |
| | T_C | 144 | °C |
| $I_{F(RMS)}$ | | 19 | A |
| I_{FSM} | 50 Hz | 265 | A |
| | 60 Hz | 280 | |
| I^2t | 50 Hz | 351 | A ² s |
| | 60 Hz | 320 | |
| V_{RRM} | Range | 100 to 1200 | V |
| T_J | | - 65 to 175 | °C |

ELECTRICAL SPECIFICATIONS

VOLTAGE RATINGS

| TYPE NUMBER | VOLTAGE CODE | V_{RRM} , MAXIMUM REPETITIVE PEAK REVERSE VOLTAGE V | V_{RSM} , MAXIMUM NON-REPETITIVE PEAK VOLTAGE V | $V_{R(BR)}$, MINIMUM AVALANCHE VOLTAGE V ⁽¹⁾ | I_{RRM} MAXIMUM AT $T_J = 175$ °C mA |
|-------------|--------------|--|--|---|---|
| 12F(R) | 10 | 100 | 150 | - | 12 |
| | 20 | 200 | 275 | - | |
| | 40 | 400 | 500 | 500 | |
| | 60 | 600 | 725 | 750 | |
| | 80 | 800 | 950 | 950 | |
| | 100 | 1000 | 1200 | 1150 | |
| | 120 | 1200 | 1400 | 1350 | |

Note

⁽¹⁾ Avalanche version only available from V_{RRM} 400 V to 1200 V

12F(R) Series



Vishay High Power Products Standard Recovery Diodes (Stud Version), 12 A

| FORWARD CONDUCTION | | | | | |
|---|---------------|---|----------------------------|---|---------------------------|
| PARAMETER | SYMBOL | TEST CONDITIONS | | VALUES | UNITS |
| Maximum average forward current at case temperature | $I_{F(AV)}$ | 180° conduction, half sine wave | | 12 | A |
| | | | | 144 | °C |
| Maximum RMS forward current | $I_{F(RMS)}$ | | | 19 | A |
| Maximum on-repetitive peak reverse power | $P_R^{(1)}$ | 10 μ s square pulse, $T_J = T_J$ maximum | | 7 | K/W |
| Maximum peak, one-cycle forward, non-repetitive surge current | I_{FSM} | t = 10 ms | No voltage reappplied | Sinusoidal half wave, initial $T_J = T_J$ maximum | A |
| | | t = 8.3 ms | | | |
| | | t = 10 ms | 100 % V_{RRM} reappplied | | |
| | | t = 8.3 ms | | | |
| Maximum I^2t for fusing | I^2t | t = 10 ms | No voltage reappplied | A ² s | |
| | | t = 8.3 ms | | | |
| | | t = 10 ms | 100 % V_{RRM} reappplied | | |
| | | t = 8.3 ms | | | |
| Maximum $I^2\sqrt{t}$ for fusing | $I^2\sqrt{t}$ | t = 0.1 to 10 ms, no voltage reappplied | | 3510 | A ² \sqrt{s} |
| Low level value of threshold voltage | $V_{F(TO)1}$ | $(16.7\% \times \pi \times I_{F(AV)} < I < \pi \times I_{F(AV)})$, $T_J = T_J$ maximum | | 0.77 | V |
| High level value of threshold voltage | $V_{F(TO)2}$ | $(I > \pi \times I_{F(AV)})$, $T_J = T_J$ maximum | | 0.97 | |
| Low level value of forward slope resistance | r_{f1} | $(16.7\% \times \pi \times I_{F(AV)} < I < \pi \times I_{F(AV)})$, $T_J = T_J$ maximum | | 10.70 | m Ω |
| High level value of forward slope resistance | r_{f2} | $(I > \pi \times I_{F(AV)})$, $T_J = T_J$ maximum | | 6.20 | |
| Maximum forward voltage drop | V_{FM} | $I_{pk} = 38$ A, $T_J = 25$ °C, $t_p = 400$ μ s rectangular wave | | 1.26 | V |

Note

(1) Available only for avalanche version, all other parameters the same as 12F

| THERMAL AND MECHANICAL SPECIFICATIONS | | | | | |
|--|------------|---|--|-----------------|----------|
| PARAMETER | SYMBOL | TEST CONDITIONS | | VALUES | UNITS |
| Maximum junction operating temperature range | T_J | | | - 65 to 175 | °C |
| Maximum storage temperature range | T_{Stg} | | | - 65 to 200 | |
| Maximum thermal resistance, junction to case | R_{thJC} | DC operation | | 2 | K/W |
| Maximum thermal resistance, case to heatsink | R_{thCS} | Mounting surface, smooth, flat and greased | | 0.5 | |
| Allowable mounting torque | | Not lubricated threads | | 1.5 + 0 - 10 % | N · m |
| | | | | 13 | lbf · in |
| | | Lubricated threads | | 1.2 + 0 - 10 % | N · m |
| | | | | 10 | lbf · in |
| Approximate weight | | | | 7 | g |
| | | | | 0.25 | oz. |
| Case style | | See dimensions - link at the end of datasheet | | DO-203AA (DO-4) | |



| ΔR_{thJC} CONDUCTION | | | | |
|------------------------------|-----------------------|------------------------|---|-------|
| CONDUCTION ANGLE | SINUSOIDAL CONDUCTION | RECTANGULAR CONDUCTION | TEST CONDITIONS | UNITS |
| 180° | 0.33 | 0.26 | T _J = T _J maximum | K/W |
| 120° | 0.41 | 0.44 | | |
| 90° | 0.53 | 0.58 | | |
| 60° | 0.78 | 0.81 | | |
| 30° | 1.28 | 1.29 | | |

Note

- The table above shows the increment of thermal resistance R_{thJC} when devices operate at different conduction angles than DC

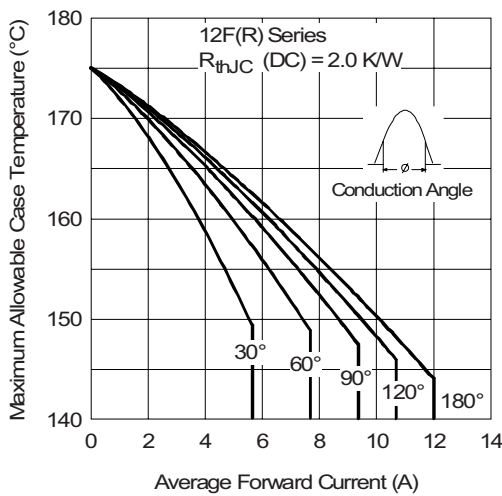

Fig. 1 - Current Ratings Characteristics

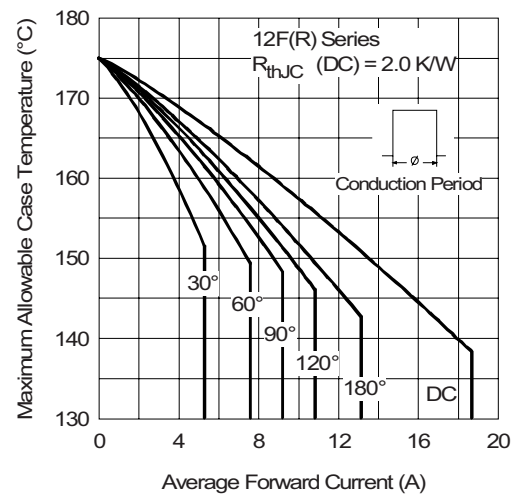

Fig. 2 - Current Ratings Characteristics

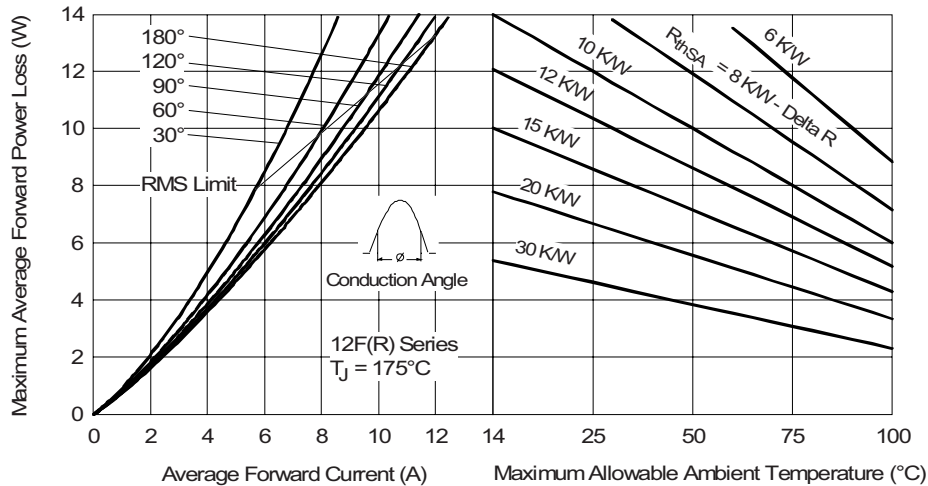

Fig. 3 - Forward Power Loss Characteristics

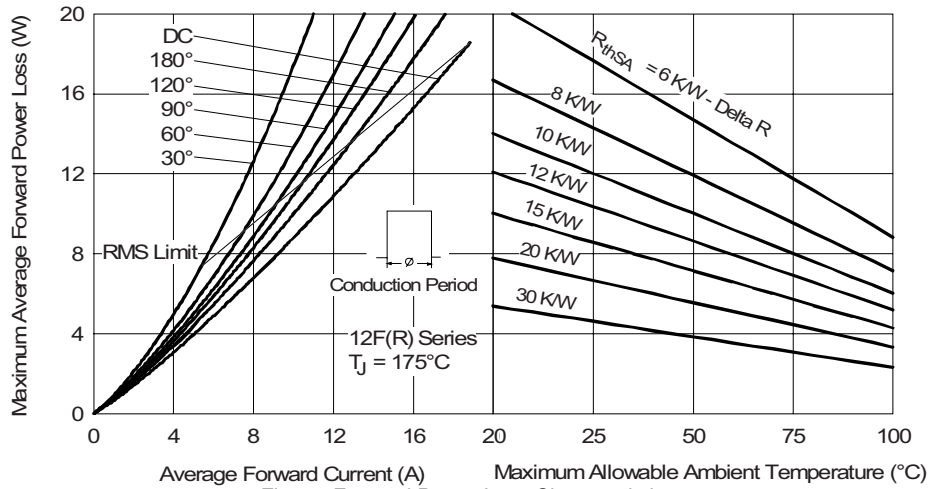

Fig. 4 - Forward Power Loss Characteristics

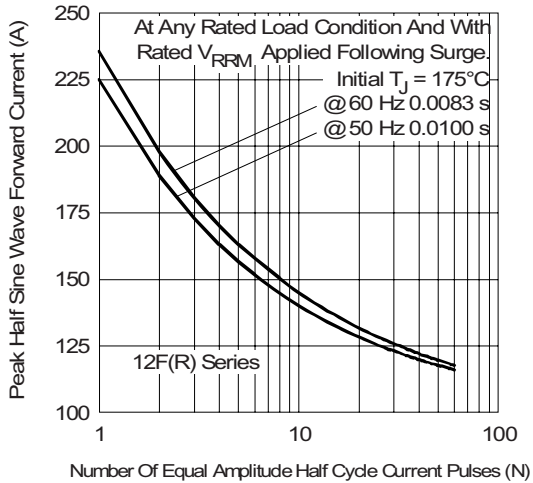

Fig. 5 - Maximum Non-Repetitive Surge Current

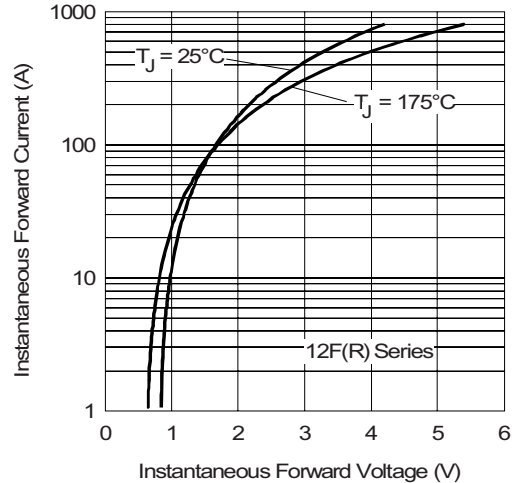

Fig. 7 - Forward Voltage Drop Characteristics

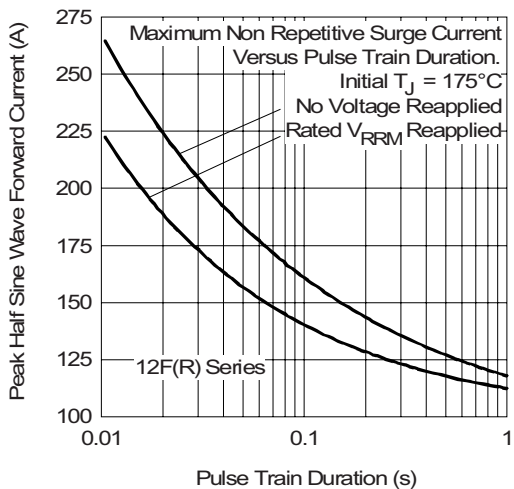

Fig. 6 - Maximum Non-Repetitive Surge Current

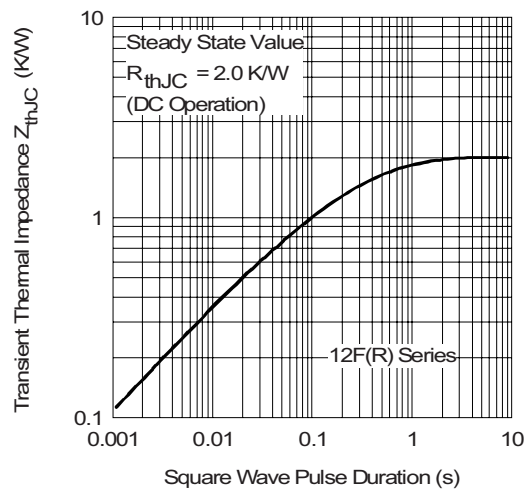
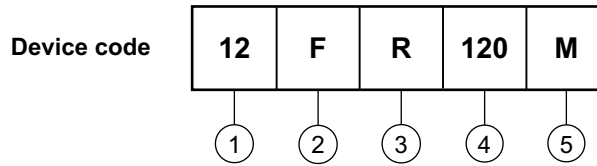

Fig. 8 - Thermal Impedance Z_{thJC} Characteristics



ORDERING INFORMATION TABLE



- 1** - Current rating: Code = $I_{F(AV)}$
- 2** - F = Standard device
- 3** - None = Stud normal polarity (cathode to stud)
R = Stud reverse polarity (anode to stud)
- 4** - Voltage code x 10 = V_{RRM} (see Voltage Ratings table)
- 5** - None = Stud base DO-203AA (DO-4) 10-32UNF-2A
M = Stud base DO-203AA (DO-4) M5 x 0.8
(not available for avalanche diodes)

| LINKS TO RELATED DOCUMENTS | |
|----------------------------|---|
| Dimensions | http://www.vishay.com/doc?95311 |

DO-203AA (DO-4)

DIMENSIONS in millimeters (inches)

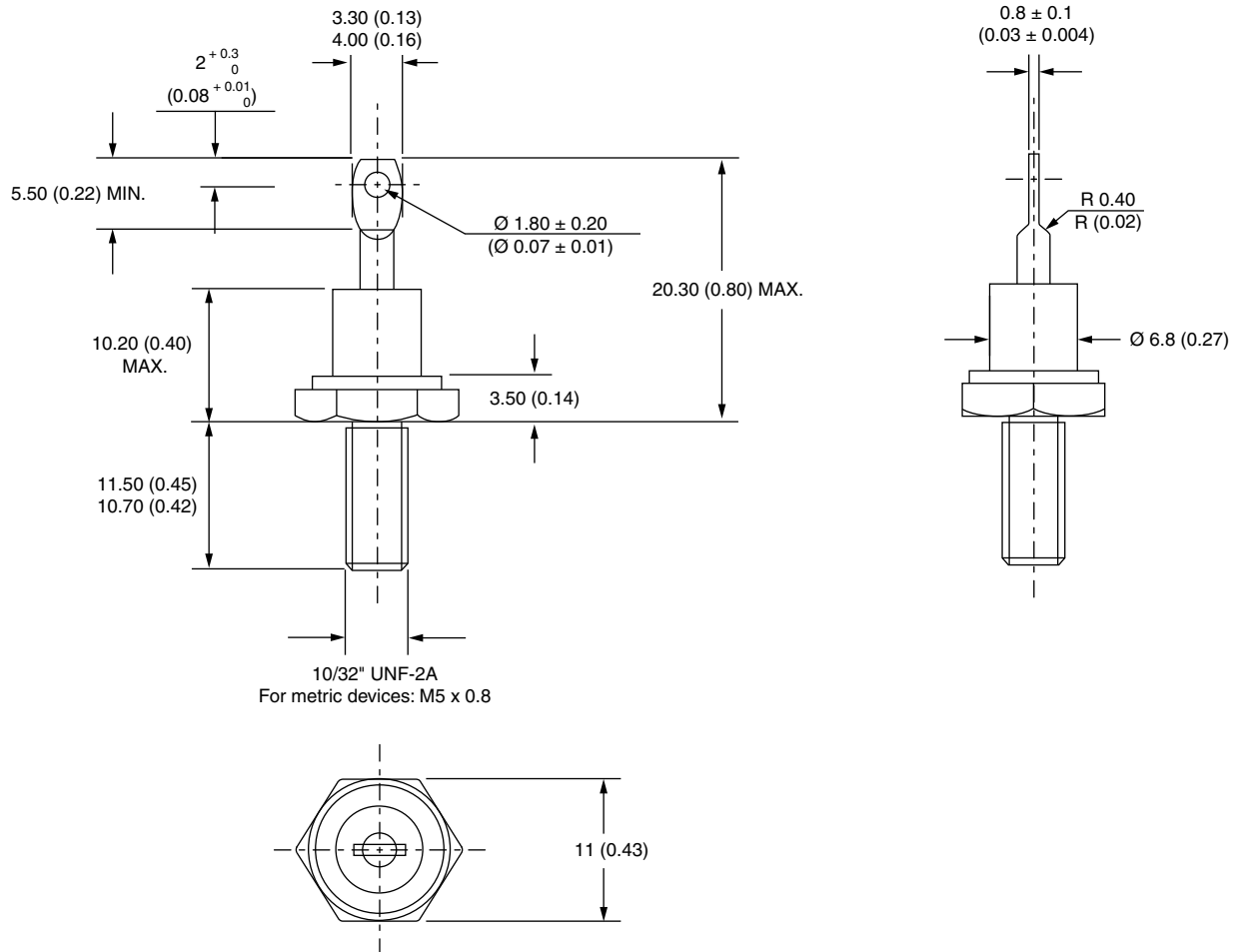



Disclaimer

ALL PRODUCT, PRODUCT SPECIFICATIONS AND DATA ARE SUBJECT TO CHANGE WITHOUT NOTICE TO IMPROVE RELIABILITY, FUNCTION OR DESIGN OR OTHERWISE.

Vishay Intertechnology, Inc., its affiliates, agents, and employees, and all persons acting on its or their behalf (collectively, "Vishay"), disclaim any and all liability for any errors, inaccuracies or incompleteness contained in any datasheet or in any other disclosure relating to any product.

Vishay makes no warranty, representation or guarantee regarding the suitability of the products for any particular purpose or the continuing production of any product. To the maximum extent permitted by applicable law, Vishay disclaims (i) any and all liability arising out of the application or use of any product, (ii) any and all liability, including without limitation special, consequential or incidental damages, and (iii) any and all implied warranties, including warranties of fitness for particular purpose, non-infringement and merchantability.

Statements regarding the suitability of products for certain types of applications are based on Vishay's knowledge of typical requirements that are often placed on Vishay products in generic applications. Such statements are not binding statements about the suitability of products for a particular application. It is the customer's responsibility to validate that a particular product with the properties described in the product specification is suitable for use in a particular application. Parameters provided in datasheets and/or specifications may vary in different applications and performance may vary over time. All operating parameters, including typical parameters, must be validated for each customer application by the customer's technical experts. Product specifications do not expand or otherwise modify Vishay's terms and conditions of purchase, including but not limited to the warranty expressed therein.

Except as expressly indicated in writing, Vishay products are not designed for use in medical, life-saving, or life-sustaining applications or for any other application in which the failure of the Vishay product could result in personal injury or death. Customers using or selling Vishay products not expressly indicated for use in such applications do so at their own risk and agree to fully indemnify and hold Vishay and its distributors harmless from and against any and all claims, liabilities, expenses and damages arising or resulting in connection with such use or sale, including attorneys fees, even if such claim alleges that Vishay or its distributor was negligent regarding the design or manufacture of the part. Please contact authorized Vishay personnel to obtain written terms and conditions regarding products designed for such applications.

No license, express or implied, by estoppel or otherwise, to any intellectual property rights is granted by this document or by any conduct of Vishay. Product names and markings noted herein may be trademarks of their respective owners.

Material Category Policy

Vishay Intertechnology, Inc. hereby certifies that all its products that are identified as RoHS-Compliant fulfill the definitions and restrictions defined under Directive 2011/65/EU of The European Parliament and of the Council of June 8, 2011 on the restriction of the use of certain hazardous substances in electrical and electronic equipment (EEE) - recast, unless otherwise specified as non-compliant.

Please note that some Vishay documentation may still make reference to RoHS Directive 2002/95/EC. We confirm that all the products identified as being compliant to Directive 2002/95/EC conform to Directive 2011/65/EU.