

O6E302

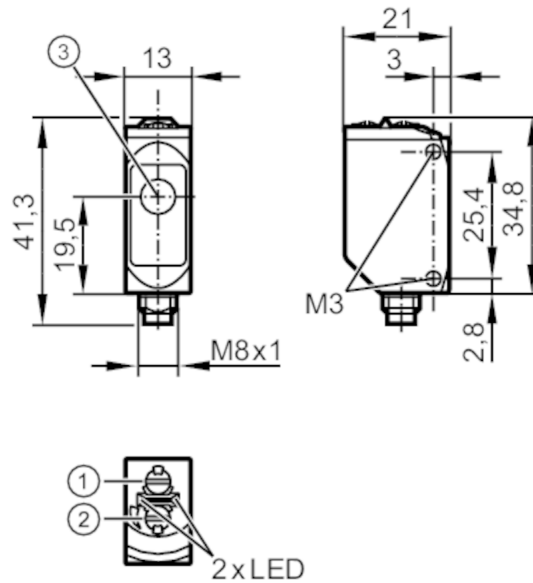

Through-beam sensor receiver

O6E-FPKG/AS/3P



- 1: output function switch
- 2: potentiometer sensitivity
- 3: Light incidence



Product characteristics

Type of light	red light
Housing	rectangular
Dimensions [mm]	34.8 x 13 x 21

Application

Function principle	Through-beam sensor
--------------------	---------------------

Electrical data

Operating voltage [V]	10...30 DC
Current consumption [mA]	7; ((24 V))
Protection class	III
Reverse polarity protection	yes
Type of light	red light
Wave length [nm]	633

Outputs

Electrical design	PNP
Output function	light-on/dark-on mode; (selectable)
Max. voltage drop switching output DC [V]	2.5
Permanent current rating of switching output DC [mA]	100
Switching frequency DC [Hz]	1000
Short-circuit protection	yes
Type of short-circuit protection	pulsed

O6E302



Through-beam sensor receiver

O6E-FPKG/AS/3P

Detection zone		
Transmitter / receiver		receiver
Range [m]		< 10
Range adjustable		yes
Operating conditions		
Ambient temperature [°C]		-25...80
Protection		IP 65; IP 67; IP 68; IP 69K
Tests / approvals		
EMC	EN 60947-5-2	
MTTF [years]		1014
UL approval	UL Approval no.	E001
Mechanical data		
Weight [g]		33.5
Housing		rectangular
Dimensions [mm]		34.8 x 13 x 21
Materials		housing: stainless steel (1.4404 / 316L); plastics: PPSU; Sealing: EPDM
Lens material		PMMA
Lens alignment		side lens
Displays / operating elements		
Display	switching status	1 x LED, yellow
	operation	1 x LED, green
Remarks		
Remarks		operating voltage "supply class 2" according to cULus
Pack quantity		1 pcs.
Electrical connection		
Connector: 1 x M8		

Through-beam sensor receiver

O6E-FPKG/AS/3P

Connection



Diagrams and graphs

excess gain graph

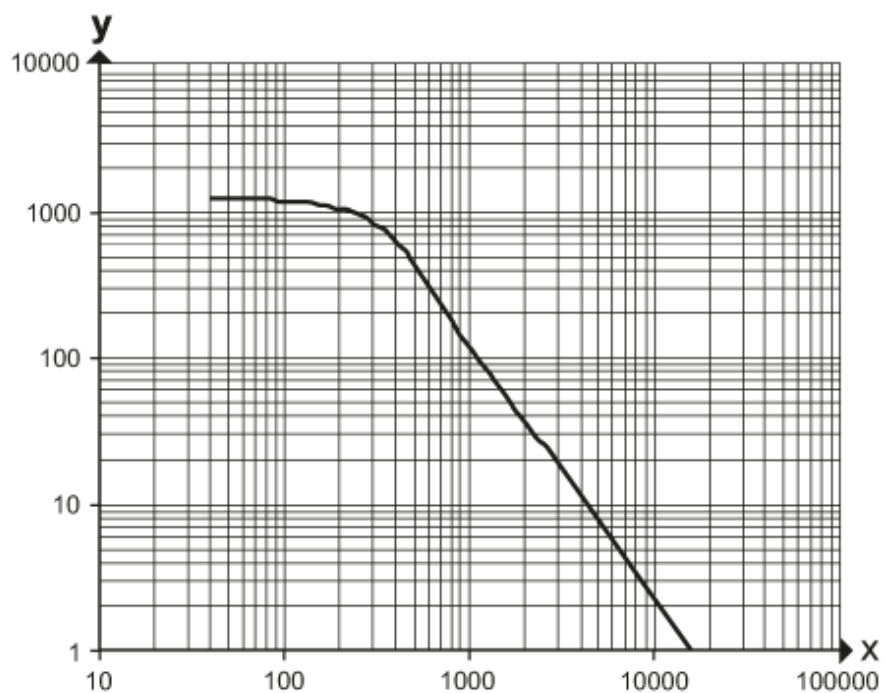

x: distance [mm]

y: excess gain factor