

### Description

The 2016L Series device provides surface mount overcurrent protection for low voltage ( $\leq 60V$ ) applications where resettable protection is desired.



### Features

- RoHS compliant and lead-free
- High voltage
- Fast response to fault currents
- Low-profile



### Applications

- IEE1394 port protection
- Powered ethernet port protection (IEEE 802.3 af)
- Automotive electronic control module protection
- Low voltage telecom equipment protection

### Agency Approvals

AGENCY	AGENCY FILE NUMBER
	E183209
	R50119118

### Electrical Characteristics

Part Number	Marking	$I_{hold}$ (A)	$I_{trip}$ (A)	$V_{max}$ (Vdc)	$I_{max}$ (A)	$P_d$ max. (W)	Maximum Time To Trip		Resistance			Agency Approvals	
							Current (A)	Time (Sec.)	$R_{min}$ ( $\Omega$ )	$R_{typ}$ ( $\Omega$ )	$R_{1max}$ ( $\Omega$ )		
2016L030	LF030	0.30	0.60	60	20	1.40	1.50	3.00	0.500	1.400	2.300	X	X
2016L050	LF050	0.55	1.10	60	20	1.40	2.50	5.00	0.200	0.700	1.000	X	X
2016L100	LF100	1.10	2.20	15	40	1.40	8.00	0.50	0.100	0.250	0.400	X	X
2016L100/33	LF100-33	1.10	2.20	33	40	1.40	8.00	0.50	0.100	0.250	0.400	X	X
2016L150	LF150	1.50	3.00	15	40	1.40	8.00	1.00	0.070	0.130	0.180	X	X
2016L200	LF200	2.00	4.20	6	40	1.40	8.00	3.00	0.048	0.070	0.100	X	X

$I_{hold}$  = Hold current: maximum current device will pass without tripping in 20°C still air.

$I_{trip}$  = Trip current: minimum current at which the device will trip in 20°C still air.

$V_{max}$  = Maximum voltage device can withstand without damage at rated current ( $I_{max}$ )

$I_{max}$  = Maximum fault current device can withstand without damage at rated voltage ( $V_{max}$ )

$P_d$  = Power dissipated from device when in the tripped state at 20°C still air.

$R_{min}$  = Minimum resistance of device in initial (un-soldered) state.

$R_{typ}$  = Typical resistance of device in initial (un-soldered) state.

$R_{1max}$  = Maximum resistance of device at 20°C measured one hour after tripping or reflow soldering of 260°C for 20 sec.

**Caution:** Operation beyond the specified rating may result in damage and possible arcing and flame.

**Temperature Rerating**

Part Number	Ambient Operation Temperature								
	-40°C	-20°C	0°C	23°C	40°C	50°C	60°C	70°C	85°C
2016L030	0.45	0.40	0.35	0.30	0.25	0.23	0.20	0.18	0.14
2016L050	0.93	0.80	0.65	0.50	0.38	0.32	0.25	0.19	0.09
2016L100	1.66	1.47	1.29	1.10	0.91	0.83	0.73	0.64	0.50
2016L100/33	1.66	1.47	1.29	1.10	0.91	0.83	0.73	0.64	0.50
2016L150	2.26	2.00	1.76	1.50	1.24	1.13	1.00	0.87	0.68
2016L200	2.80	2.50	2.19	2.00	1.84	1.74	1.50	1.34	1.14

**Average Time Current Curves**

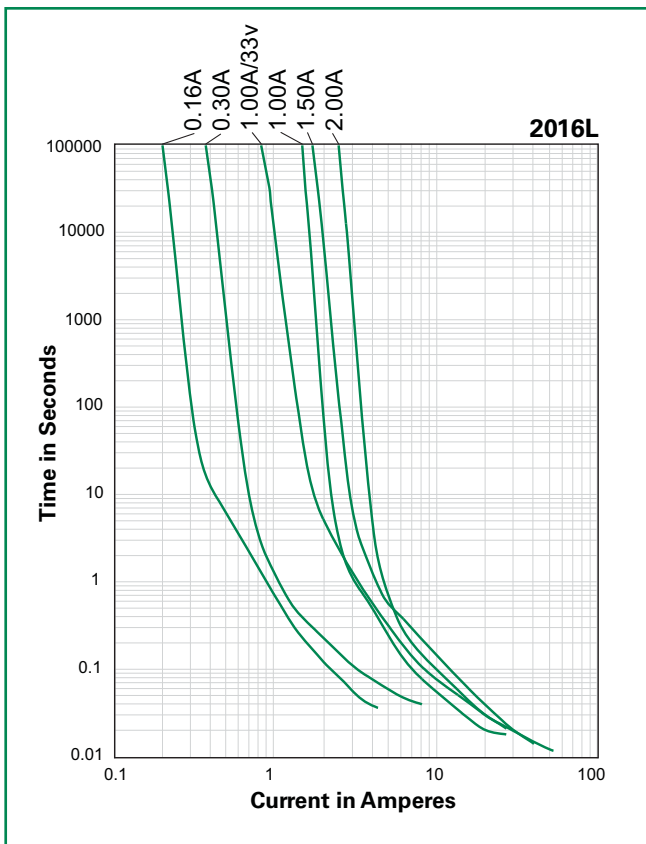

**Temperature Rerating Curve**

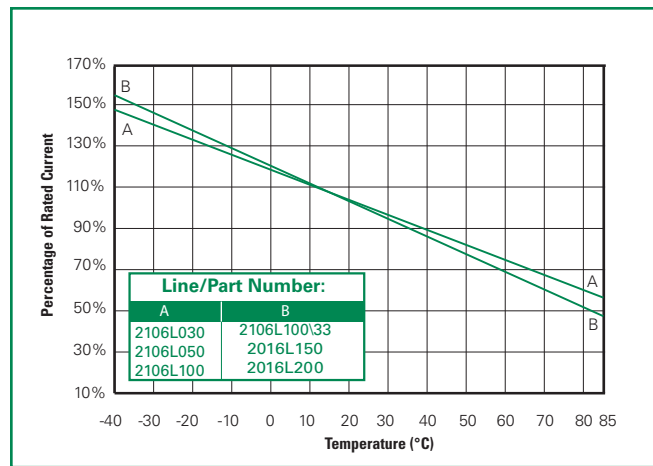

The average time current curves and Temperature Rerating curve performance is affected by a number of variables, and these curves provided as guidance only. Customer must verify the performance in their application.

### Soldering Parameters

Condition	Reflow
Peak Temp/ Duration Time	260°C / 10 Sec
Time above liquids (TAL) 220°C	60 Sec ~ 100 Sec
Preheat 120°C~ 180°C	50 Sec ~ 150 Sec
Storage Condition	0°C~35°C, ≤70%RH

- Recommended reflow methods: IR, vapor phase oven, hot air oven, N<sub>2</sub> environment for lead-free
- Recommended maximum paste thickness is 0.25mm (0.010 inch)
- Devices can be cleaned using standard industry methods and solvents.

**Note:** If reflow temperatures exceed the recommended profile, devices may not meet the performance requirements.

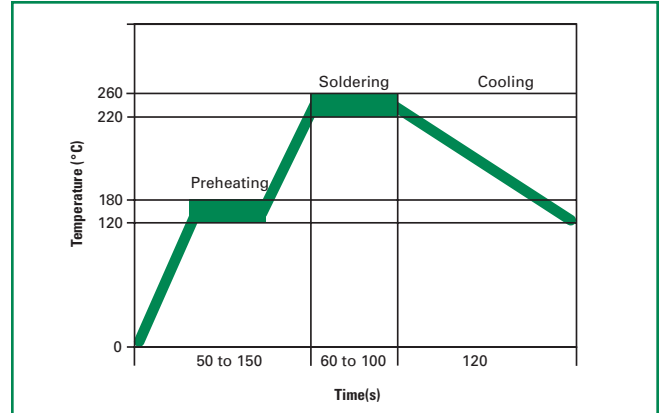

### Physical Specifications

Terminal Material	Solder-Plated Copper (Solder Material: Matte Tin(Sn))
Lead Solderability	Meets EIA Specification RS186-9E, ANSI/J-STD-002 Category 3.

### Environmental Specifications

Operating/Storage Temperature	-40°C to +85°C
Maximum Device Surface Temperature in Tripped State	125°C
Passive Aging	+85°C, 1000 hours -/+5% typical resistance change
Humidity Aging	+85°C, 85%, R.H., 1000 hours -/+5% typical resistance change
Thermal Shock	MIL-STD-202, Method 107G +85°C/-40°C 20 times -30% typical resistance change
Solvent Resistance	MIL-STD-202, Method 215 No change
Vibration	MIL-STD-883C, Method 2007.1, Condition A No change
Moisture Sensitivity Level	Level 2, J-STD-020C

**Dimensions (mm)**

MARKING CODE VARIES  
WITH AMPERAGE AND VOLTAGE RATING  
SEE ELECTRICAL CHARACTERISTICS CHART  
SHOWN ARE:  
- 1.1A/15V RATING (LEFT)  
- 1.1A/33V RATING (RIGHT)

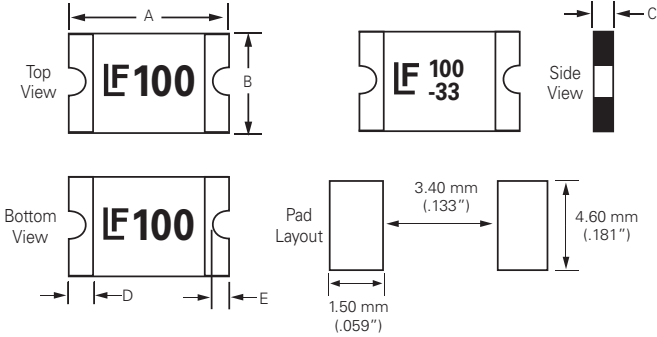

Part Number	A				B				C				D		E			
	Inches		mm		Inches		mm		Inches		mm		Inches	mm	Inches	mm	Inches	mm
	Min.	Max.	Min.	Max.	Min.	Max.	Min.	Max.	Min.	Max.	Min.	Max.	Min.	Max.	Min.	Max.	Min.	Max.
2016L030	0.19	0.21	4.72	5.44	0.15	0.17	3.7	4.43	0.03	0.05	0.75	1.25	0.01	0.30	0.01	0.03	0.25	0.65
2016L050	0.19	0.21	4.72	5.44	0.15	0.17	3.7	4.43	0.05	0.08	1.2	2	0.01	0.30	0.01	0.03	0.25	0.65
2016L100	0.19	0.21	4.72	5.44	0.15	0.17	3.7	4.43	0.02	0.03	0.5	0.75	0.01	0.30	0.01	0.03	0.25	0.65
2016L100/33	0.19	0.21	4.72	5.44	0.15	0.17	3.7	4.43	0.03	0.05	0.75	1.25	0.01	0.30	0.01	0.03	0.25	0.65
2016L150	0.19	0.21	4.72	5.44	0.15	0.17	3.7	4.43	0.03	0.06	0.75	1.55	0.01	0.30	0.01	0.03	0.25	0.65
2016L200	0.19	0.21	4.72	5.44	0.15	0.17	3.7	4.43	0.02	0.03	0.5	0.75	0.01	0.30	0.01	0.03	0.25	0.65

**Part Ordering Number System**

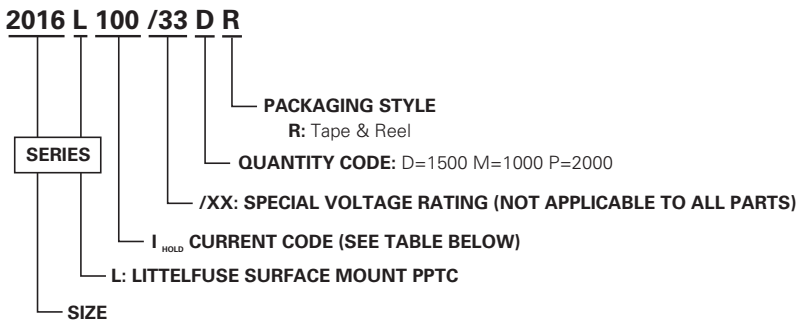

**Packaging**

Part Number	Ordering Number	I <sub>hold</sub> (A)	I <sub>hold</sub> Code	Voltage Option	Packaging Option	Quantity	Quantity & Packaging Codes
2016L030	2016L030DR	0.30	030		Tape and Reel	1500	DR
2016L050	2016L050MR	0.55	050		Tape and Reel	1000	MR
2016L100	2016L100PR	1.10	110		Tape and Reel	2000	PR
2016L100/33	2016L100/33DR	1.10	110	/33	Tape and Reel	1500	DR
2016L150	2016L150DR	1.50	150		Tape and Reel	1500	DR
2016L200	2016L200PR	2.00	200		Tape and Reel	2000	PR

**Tape and Reel Specifications**

TAPE SPECIFICATIONS: EIA-481-1 (mm)			
	2016L100 2016L200	2016L030 2016L100/33 2016L150	2016L050
<b>W</b>	12.0+/-0.30	12.0+/-0.30	12.0+/-0.30
<b>F</b>	5.50+/-0.05	5.50+/-0.05	5.50+/-0.05
<b>E<sub>1</sub></b>	1.75+/-0.10	1.75+/-0.10	1.75+/-0.10
<b>D<sub>0</sub></b>	1.55+/-0.05	1.55+/-0.05	1.55+/-0.05
<b>D<sub>1</sub></b>	1.50 (MIN)	1.50 (MIN)	1.50 (MIN)
<b>P<sub>0</sub></b>	4.0+/-0.10	4.0+/-0.10	4.0+/-0.10
<b>P<sub>1</sub></b>	8.0+/-0.10	8.0+/-0.10	8.0+/-0.10
<b>P<sub>2</sub></b>	2.0+/-0.05	2.0+/-0.05	2.0+/-0.05
<b>A<sub>0</sub></b>	4.40+/-0.10	4.48+/-0.10	4.45+/-0.10
<b>B<sub>0</sub></b>	5.50+/-0.10	5.40+/-0.10	5.48+/-0.10
<b>T</b>	0.25+/-0.10	0.25+/-0.10	0.25+/-0.10
<b>K<sub>0</sub></b>	0.80+/-0.10	1.36+/-0.10	1.86+/-0.10
<i>Leader Min.</i>	390	390	390
<i>Trailer Min.</i>	160	160	160

REEL DIMENSIONS: EIA-481-1 (mm)	
<b>H</b>	12.0+/-0.05
<b>W</b>	9.0+/-0.5
<b>D</b>	Ø 60+0.5
<b>F</b>	Ø13.0+/-0.2
<b>C</b>	Ø178+/-1.0
<b>H<sub>1</sub></b>	11+/-0.5
<b>W<sub>1</sub></b>	2.2+/-0.5
<b>W<sub>2</sub></b>	3.0+0.5
<b>W<sub>3</sub></b>	4.0+0.5
<b>W<sub>4</sub></b>	5.5+0.5

2016L Series

**Tape and Reel Diagram**

