



# EV2651-VT-00A

## I<sup>2</sup>C-Controlled 1-Cell to 4-Cell Buck-Boost Charger with Reverse Source Mode Evaluation Board

### DESCRIPTION

The EV2651-VT-00A is an evaluation board designed to demonstrate the capabilities of the MP2651, a buck-boost charger IC designed for battery packs with 1 cell to 4 cells in series. The device can accept a wide 4V to 22V input voltage ( $V_{IN}$ ) range to charge the battery. It also supplies a wide 3V to 21V voltage range at the IN pin in source mode. This function is compliant to the USB PD specifications.

When input power is present, the board charges the battery with a maximum 6A charge current. When source mode is enabled, the device has an output current ( $I_{OUT}$ ) limit up to 6A.

With the I<sup>2</sup>C/SMBus interface, the MP2651 can flexibly configure the charge and discharge parameters. The I<sup>2</sup>C interface can also provide the device and fault statuses through the registers.

### PERFORMANCE SUMMARY <sup>(1) (2)</sup>

Specifications are at  $T_A = 25^\circ\text{C}$ , unless otherwise noted.

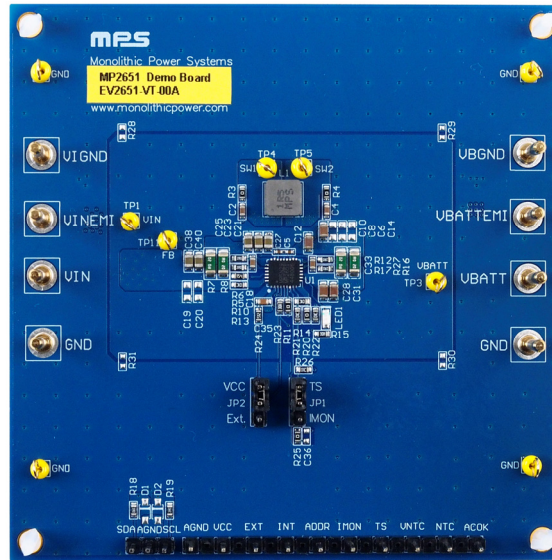
Parameters	Conditions	Value
Input voltage ( $V_{IN}$ ) range		4V to 22V
Battery charge regulation voltage ( $V_{BATT\_REG}$ )	2 cells	8.4V (I <sup>2</sup> C-configurable)
Fast charge current ( $I_{CC}$ )	$V_{IN} = 9\text{V to }22\text{V}$	2A (I <sup>2</sup> C-configurable)
Output voltage in source mode ( $V_{IN\_SRC}$ ) range		3V to 21V
Output voltage in source mode ( $V_{IN\_SRC}$ )		4.98V (I <sup>2</sup> C-configurable)
Output current limit in source mode ( $I_{IN\_SRC}$ )		2A (I <sup>2</sup> C-configurable)
Charge typical efficiency	$V_{IN} = 20\text{V}, V_{BATT} = 8\text{V}, I_{CC} = 2\text{A}$	93.09%
Charge peak efficiency	$V_{IN} = 12\text{V}, V_{BATT} = 8\text{V}, I_{CC} = 2\text{A}$	96.27%
Source mode typical efficiency	$V_{BATT} = 7.4\text{V}, V_{IN\_SRC} = 20\text{V}, I_{IN\_SRC} = 1.5\text{A}$	93.5%
Source mode peak efficiency	$V_{BATT} = 8.4\text{V}, V_{IN\_SRC} = 12\text{V}, I_{IN\_SRC} = 1.5\text{A}$	96.37%
Switching frequency ( $f_{SW}$ )		600kHz (I <sup>2</sup> C-configurable)

**Note:**

1) Refer to the MP2651 datasheet for more details.

 Optimized Performance with the MPS Inductor MPL-AL5030 Series

EVALUATION BOARD



LxWxH (8.9cmx8.9cmx0.8cm)

Board Number	MPS IC Number
EV2651-VT-00A	MP2651GVT-000A

## QUICK START GUIDE

This evaluation board is designed for MP2651 when the MP2651 is used as a buck-boost charger to charge a 2-cell battery pack. Its layout accommodates most commonly used resistors and capacitors. This board is preset for charge mode, and the full-charge voltage is preset to 8.4V. In charge mode, the IC can work in buck or buck-boost mode automatically, according to the input and battery voltages.

Follow the steps below to prepare the evaluation board:

1. Ensure that the computer has at least one USB port and a USB cable. The MP2651 evaluation software must be properly installed.
2. Connect the USB-to-I<sup>2</sup>C communication kit (EVKT-USBI2C-02) (see Figure 1).



**Figure 1: USB-to-I<sup>2</sup>C Communication Kit**

3. To enable the software, double-click on the “MP2651 Evaluation Kit” .exe file to run the MP2651 evaluation software. The software supports Windows 7 and Windows 10 operating systems.

The MP2651 evaluation kit.exe file can be downloaded from the MPS website.

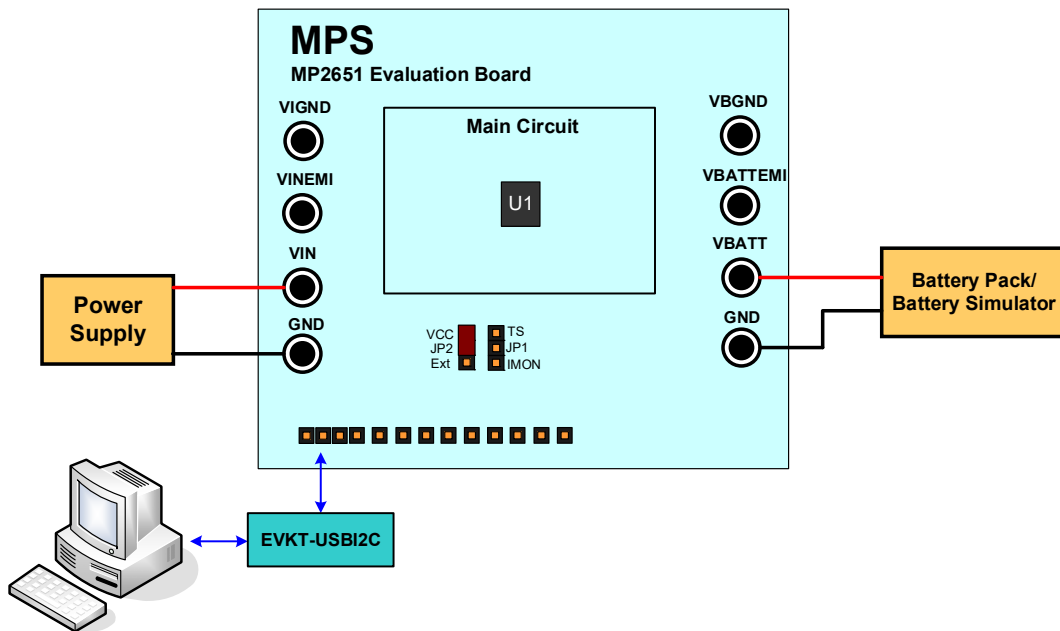
### Original Test Set-Up for the MP2651

1. Connect the battery terminals to:
  - a. Positive (+): VBATT
  - b. Negative (-): GNDIf using a battery simulator, preset the battery voltage between 0V and 8.4V, then turn the battery off. Connect the battery simulator outputs to the VBATT and GND pins, respectively.
2. Ensure that the battery voltage is present (if using a battery simulator, turn the simulator on after making the connection).
3. For charge mode testing, connect the input terminals to:
  - a. Positive (+): VIN
  - b. Negative (-): GND
4. For source mode testing, connect the load terminals to:
  - a. Positive (+): VIN
  - b. Negative (-): GND
5. For EMI testing, connect the input or load terminals to:
  - a. Positive (+): VINEMI
  - b. Negative (-): VIGND
6. For EMI testing, connect the battery terminals to:
  - a. Positive (+): VBATTEMI

b. Negative (-): VBGND

7. Remove all other connectors (VIN, GND, VBATT, and GND) and pin headers.

Figure 2 shows the charge mode testing set-up.



**Figure 2: MP2651 Charge Mode Test Set-Up**

Table 1 shows how to set the jumpers.

**Table 1: Jumper Connections**

Jack	Description	Default Setting
JP1 <sup>(2)</sup>	To select the pull-voltage, pull JP1 up to VCC or an external power source.	Pull JP1 up to VCC
JP2 <sup>(3)</sup>	For the TS/IMON connection, connect pin 7 to different external circuitry depending on the TS/IMON selection.	Open

**Notes:**

- 2) If JP1 is pulled up to an external source, add an external power source (e.g. 3.3V) to AGND. Otherwise, no other actions are required.
- 3) If TS/IMON has different external circuitry, connect the TS/IMON pin to the corresponding circuit with I<sup>2</sup>C control.

8. Launch the MP2651 evaluation software. The main software window should show up on the screen (see Figure 3 on page 5).

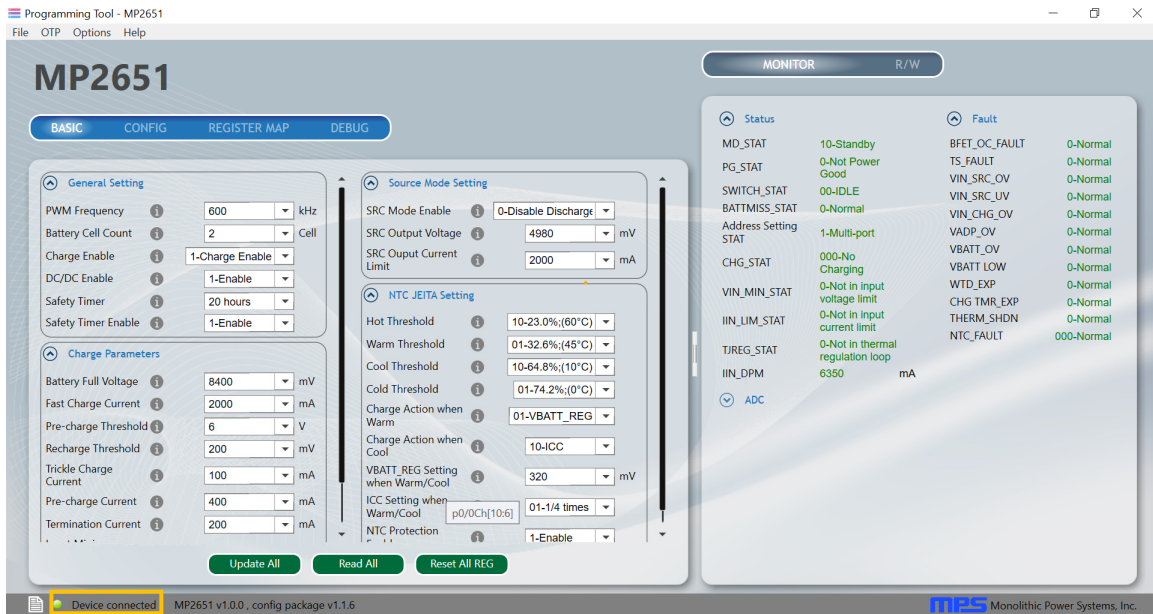


Figure 3: MP2651 Evaluation Software

9. Turn on the VIN pin. The MP2651 should work to charge the battery with the default settings.

### Modifying Parameters via the GUI

To use MPS’s GUI, ensure that all connections are successful, such as the connections between the computer, USB-to-I<sup>2</sup>C communication kit, and the evaluation board.

### BASIC Page

Figure 4 shows the MP2651’s basic settings.



Figure 4: MP2651 Basic Settings

The general settings include the PWM switching frequency, battery cell count, safety charge timer, the charge mode control and DC/DC converter control (see Figure 5).

General Setting	
PWM Frequency	600 kHz
Battery Cell Count	2 Cell
Charge Enable	1-Charge Enable
DC/DC Enable	1-Enable
Safety Timer	20 hours
Safety Timer Enable	1-Enable

**Figure 5: General Settings**

Note that the recommended switching frequency ( $f_{sw}$ ) is between 500kHz and 800kHz.

### Charge Mode Settings

The charge mode parameters include the battery-full voltage, fast charge current, pre-charge threshold, recharge threshold, trickle charge current, pre-charge current, and termination current. The power path management parameters include the input minimum voltage limit and input current limit (see Figure 6).

Charge Parameters	
Battery Full Voltage	8400 mV
Fast Charge Current	2000 mA
Pre-charge Threshold	6 V
Recharge Threshold	200 mV
Trickle Charge Current	100 mA
Pre-charge Current	400 mA
Termination Current	200 mA
Input Minimum Voltage Limit	4560 mV
Input Current Limit	500 mA

**Figure 6: Charge Mode Settings**

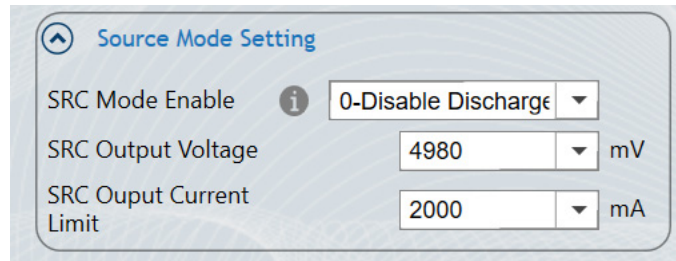
All parameters can be input using the keyboard. Figure 7 shows the JEITA parameters for battery thermal protection.

NTC JEITA Setting	
Hot Threshold	10-23.0%;(60°C)
Warm Threshold	01-32.6%;(45°C)
Cool Threshold	10-64.8%;(10°C)
Cold Threshold	01-74.2%;(0°C)
Charge Action when Warm	01-VBATT_REG
Charge Action when Cool	10-ICC
VBATT_REG Setting when Warm/Cool	320 mV
ICC Setting when Warm/Cool	01-1/4 times
NTC Protection Enable	1-Enable

**Figure 7: Battery Thermal Protection Parameters**

### Source Mode Settings

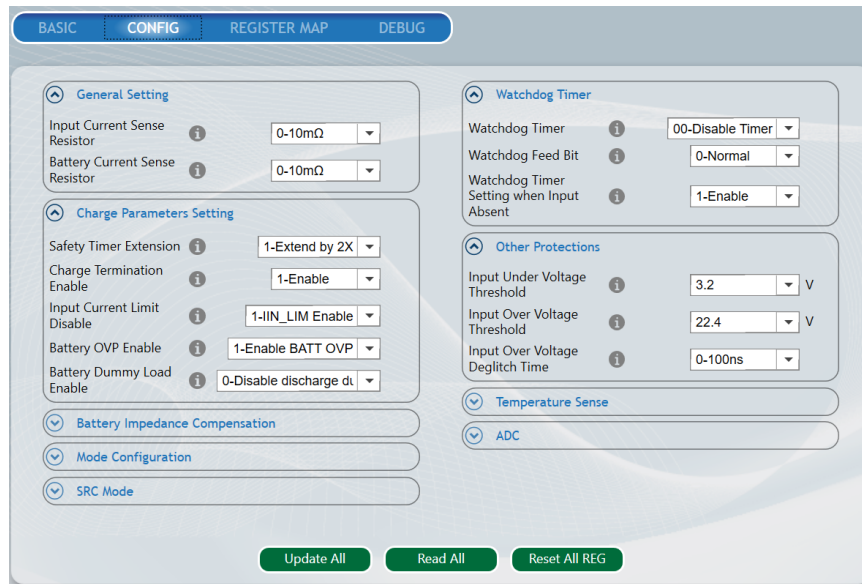
The MP2651 can work in source mode. In source mode, the battery supplies power to the IN pin. The discharge parameters include the SRC mode (enabled or disabled), SRC output voltage, and SRC output current limit (see Figure 8).



**Figure 8: Discharge Parameters**

### CONFIG Page

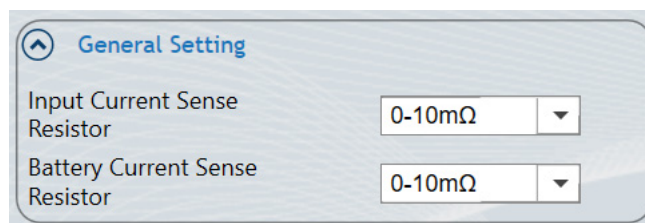
Figure 9 shows the MP2651’s configuration settings.



**Figure 9: MP2651 Configuration Settings**

### General Settings

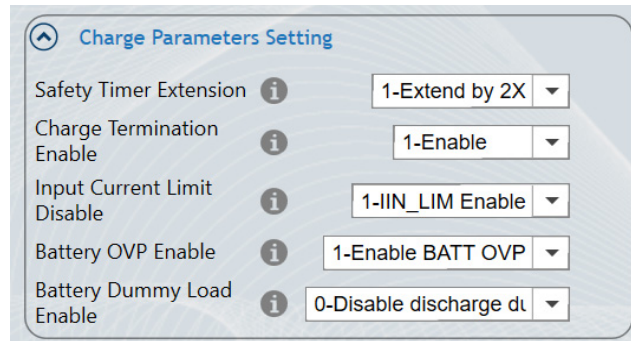
Figure 10 shows how to select the current-sense resistors.



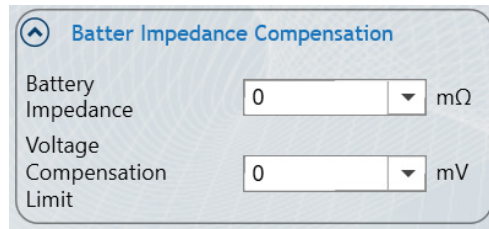
**Figure 10: Setting the Current-Sense Resistors**

### Charge Protection Settings

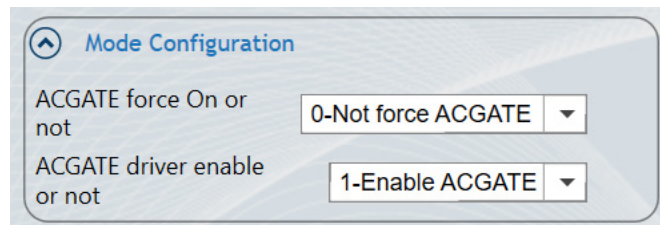
Safety timer extension control enables the user to control parameters such as charge termination, the input current limit, battery over-voltage protection (OVP), and the battery dummy load (when  $V_{BATT}$  is below 10V) (see Figure 11 on page 8).


**Figure 11: Charge Parameter Settings**

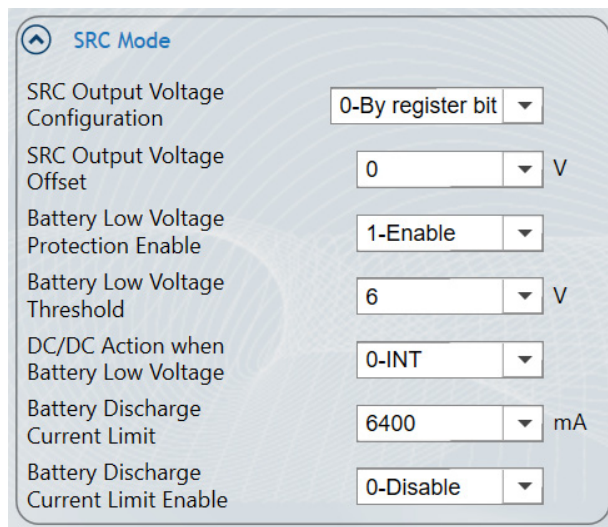
1. Select the battery impedance compensation and the voltage limit (see Figure 12).


**Figure 12: Battery Impedance Compensation**

2. Select the external MOSFET mode configuration (input connection) (see Figure 13).

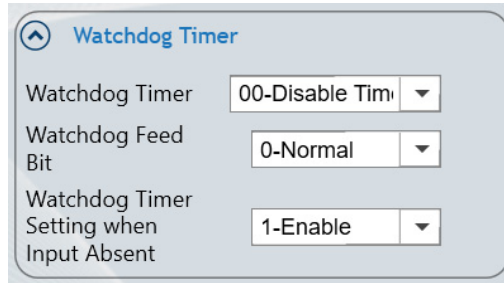

**Figure 13: External MOSFET Mode Configuration**

3. Select the parameters for SRC mode control, such as the SRC output voltage configuration and additional protections (see Figure 14).


**Figure 14: SRC Mode Configurations**



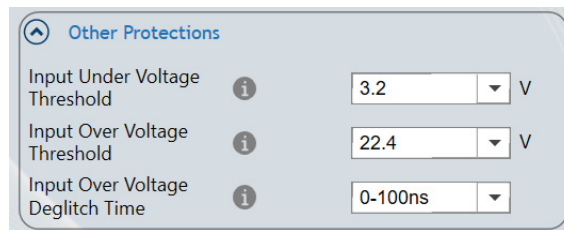
4. Select the watchdog timer settings (see Figure 15).



**Figure 15: Watchdog Timer Settings**

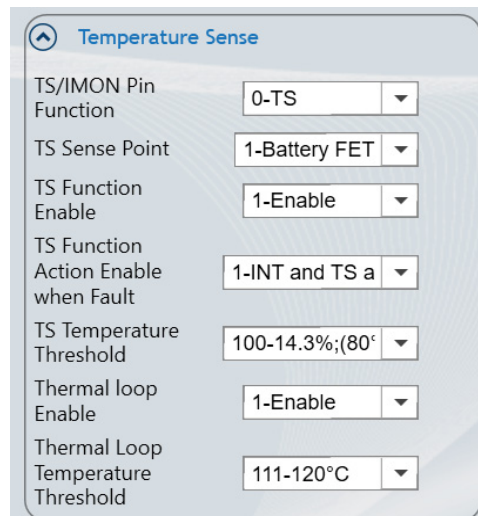
**Additional Protections**

Additional threshold settings, such as the input under-voltage threshold, input over-voltage threshold, and input over-voltage deglitch time, can also be set (see Figure 16)



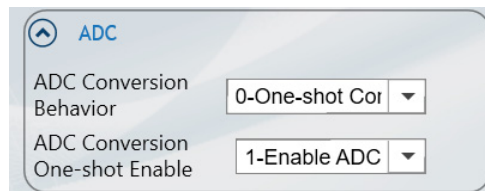
**Figure 16: Additional Protections**

1. Select the parameters for temperature-sense control. The TS/IMON pin can be set as either the temperature-sense pin (TS) or the battery monitor pin (IMON) (see Figure 17).



**Figure 17: Temperature-Sense Settings**

2. Select the ADC operation mode settings (Figure 18).



**Figure 18: ADC Settings**

### REGISTER MAP Page

The REGISTER MAP page shows all the registers results, which are matched with the display on BASIC and CONFIG page (see Figure 19).

Command code	Command name	Register Value
05H	Device Address Setting	0208
06H	Input Minimum Voltage Limit Setting	0039
07H	Minimum System Voltage Threshold	001E
08H	Input Current Limit Setting	000A
09H	Output Voltage Setting	00F9
0AH	Battery Impedance Compensation and Output Current Limit Setting	0028
0BH	Battery Low Voltage Setting and Battery Discharge Current Regulation	3080
0CH	JEITA Action Setting	3410
0DH	Temperature Protection Setting	B399
0EH	Configuration Register 0	0010
0FH	Configuration Register 1	F244
10H	Configuration Register 2	0A40
11H	Configuration Register 3	60E8
12H	Configuration Register 4	3C53
14H	Charge Current Setting	0A00

Figure 19: MP2651 Register Map Sheet

### MONITOR Page

The MONITOR page reports certain devices statuses (see Figure 20).

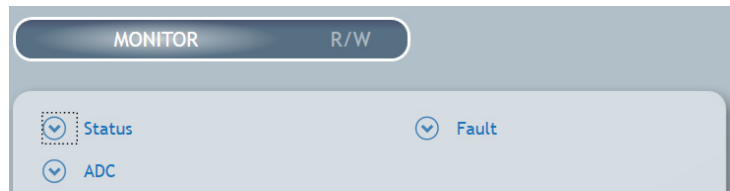


Figure 20: MP2651 Monitor Sheet

The MONITOR page indicates the general statuses (see Figure 21 on page 11).

Status		
MD_STAT	01-Operation Mode	
PG_STAT	1-Power Good	
SWITCH_STAT	11-BOOST	
BATTMISS_STAT	0-Normal	
Address Setting STAT	0-Single port	
CHG_STAT	011-CC charge	
VIN_MIN_STAT	0-Not in input voltage limit	
IIN_LIM_STAT	1-In input current limit	
TJREG_STAT	0-Not in thermal regulation loop	
IIN_DPM	500	mA

**Figure 21: General Statuses**

The MONITOR page also reports the fault statuses (see Figure 22).

Fault	
BFET_OC_FAULT	0-Normal
TS_FAULT	0-Normal
VIN_SRC_OV	0-Normal
VIN_SRC_UV	0-Normal
VIN_CHG_OV	0-Normal
VADP_OV	0-Normal
VBATT_OV	0-Normal
VBATT_LOW	0-Normal
WTD_EXP	0-Normal
CHG_TMR_EXP	0-Normal
THERM_SHDN	0-Normal
NTC_FAULT	000-Normal

**Figure 22: Fault Statuses**

The MONITOR page indicates the ADC statuses (see Figure 23).

ADC		
VIN	4800	mV
IIN	525	mA
VBATT	8050	mV
IBATT	237.5	mA
NTC	48.044	%
TS	47.946	%
TJ	29.991	°C
IBATT_DIS	175	mA
VIN_SRC	0	mV
IIN_SRC	0	mA

**Figure 23: ADC Statuses**

# EVALUATION BOARD SCHEMATIC

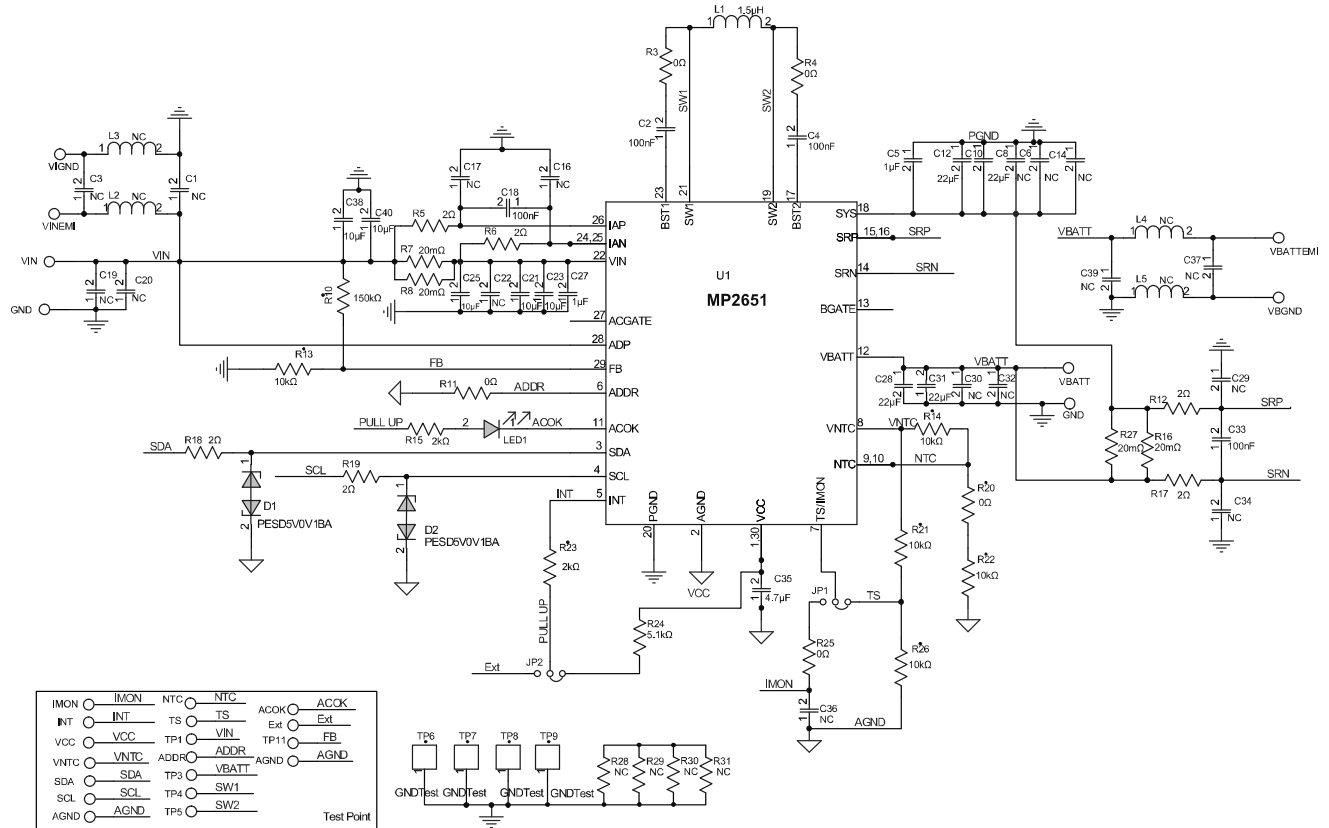


Figure 24: Evaluation Board Schematic

**EV2651-VT-00A BILL OF MATERIALS**

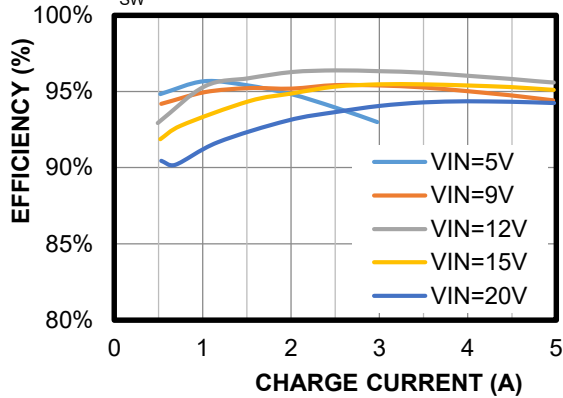
Qty	Ref	Value	Description	Package	Manufacturer	Manufacturer PN
4	L2, L3, L4, L5	NC				
5	R3, R4, R11, R20, R25	0Ω	Film resistor, 5%;	0603	Yageo	RC0603JR-070RL
6	R5, R6, R12, R17, R18, R19	2Ω	Film resistor, 5%;	0603	Liz	CR0603JA02R0G
4	R7, R8, R16, R27	20mΩ	Film resistor, 1%, 1/4W	1206	Cyntec	RL1632H-R020-FN
1	R10	150kΩ	Film resistor, 5%, 1/10W	0603	Yageo	RC0603JR-07150KL
5	R13, R14, R21, R22, R26	10kΩ	Film resistor, 1%, 1/10W	0603	Yageo	RC0603FR-0710KL
2	R15, R23	2kΩ	Film resistor, 1%	0603	Yageo	RC0603FR-072KL
1	R24	5.1kΩ	Film resistor, 5%	0603	Yageo	RC0603JR-075K1L
4	R28, R29, R30, R31	NC				
10	C1, C3, C16, C17, C22, C29, C34, C36, C37, C39	NC				
4	C2, C4, C18, C33	100nF	Ceramic capacitor, 25V, X7R	0603	Wurth	885012206071
2	C5, C27	1μF	Ceramic capacitor, 25V, X5R	0402	Murata	GRM155R61E105K A12
7	C6, C8, C14, C19, C20, C30, C32	NC				
4	C10, C12, C28, C31	22μF	Ceramic capacitor, 25V, X5R	0805	Murata	GRM21BR61E226M E44L
5	C21, C23, C25, C38, C40	10μF	Ceramic capacitor, 25V, X7S	0805	Murata	GRM21BC7E106KE 11L
1	C35	4.7μF	Capacitor, 25V, X5R	0603	Murata	GRM188R61E475K E11D
1	LED1	Red	Red LED	0805	Bright LED	BL-HUE35A-AV-TRB
2	D1, D2	NC				
13	ACOK, ADDR, AGND, AGND, Ext, IMON, INT, NTC, TS, VCC, VNTC, SCL, SDA	2.54mm	Pin header	DIP	Any	
9	TP6 (GND), TP7 (GND), TP8 (GND), TP9 (GND), TP1, TP11, TP4, TP5, TP3	TH	Test point	DIP	Any	
4	VIN, VBATT, GND, GND	2mm	Connector	DIP	Any	
4*	VINEMI, VBATTEMI, VIGND, VBGND	2mm	Connector	DIP	Any	
2	JP1, JP2	2.54mm	Pin header	DIP	Any	
2	JP1, JP2	2.54mm	Mini jumper	Shunt	Any	
1	U1	MP2651	Buck-boost charger	TQFN-30 (4mmx 5mm)	MPS	MP2651GVT-000A
1	L1	1.5μH	Inductor, 1.5μH, 9.7mΩ, 9A	SMD	MPS	MPL-AL5030-1R5

## EVB TEST RESULTS

Performance curves and waveforms are tested on the evaluation board. The default setting is for a 2-cell battery,  $I_{IN\_LIM} = 3A$ ,  $V_{BATT} = 7.4V$ ,  $I_{CC} = 3A$ ,  $T_A = 25^{\circ}C$ , unless otherwise noted.

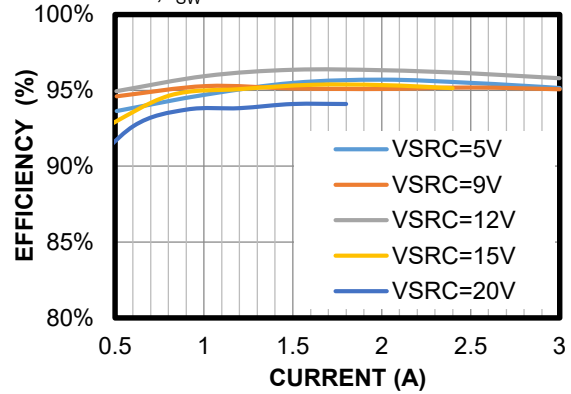
### Efficiency vs. Charge Current

Charge mode, 2-cell battery,  
 $V_{BATT} = 8V$ ,  $V_{IN} = 5V, 9V, 12V, 15V, \text{ or } 20V$ ,  
 $f_{SW} = 600kHz$



### Efficiency vs. Source Current

Source mode, 2-cell battery,  
 $V_{BATT} = 8.4V$ ,  $V_{SRC} = 5V, 9V, 12V, 15V, \text{ or } 20V$ ,  
 $f_{SW} = 600kHz$

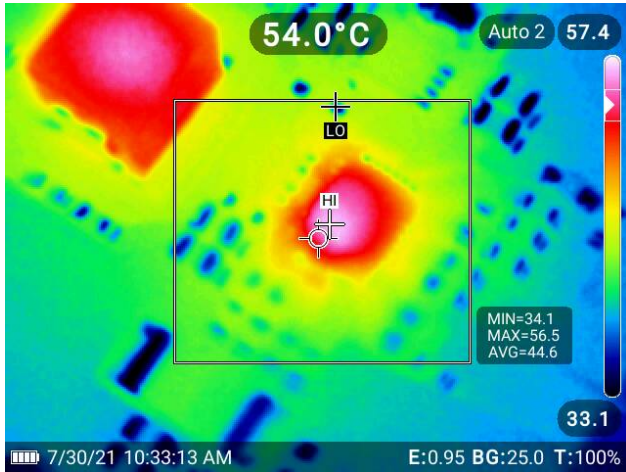


### EVB TEST RESULTS *(continued)*

Performance curves and waveforms are tested on the evaluation board. The default setting is for a 2-cell battery,  $I_{IN\_LIM} = 3A$ ,  $V_{BATT} = 7.4V$ ,  $I_{CC} = 3A$ ,  $T_A = 25^{\circ}C$ , unless otherwise noted.

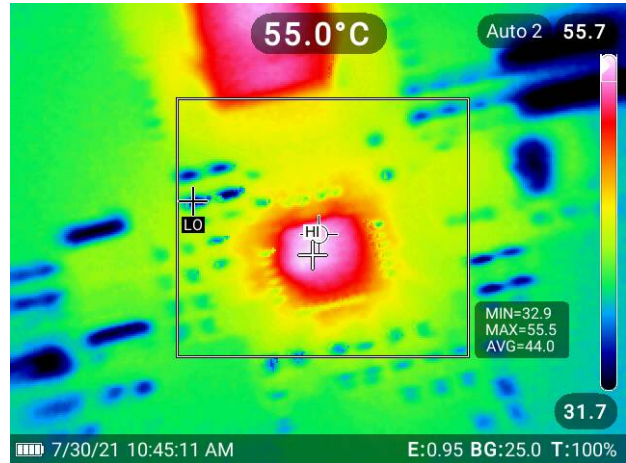
#### Thermal Performance

Charge mode,  $V_{IN} = 20V$ ,  $V_{BATT} = 8.2V$ ,  $I_{CC} = 5A$ , no forced airflow,  $T_{CASE} = 56.5^{\circ}C$



#### Thermal Performance

Source mode,  $V_{BATT} = 8.2V$ ,  $V_{IN\_SRC} = 20V$ ,  $I_{IN\_SRC} = 1.8A$ , no forced airflow,  $T_{CASE} = 55.5^{\circ}C$

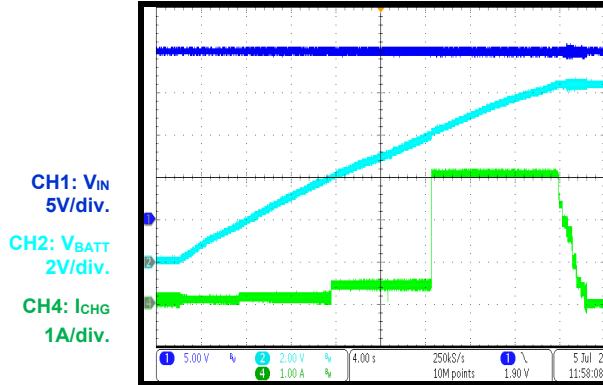


### EVB TEST RESULTS (continued)

Performance curves and waveforms are tested on the evaluation board. The default setting is for a 2-cell battery,  $I_{IN\_LIM} = 3A$ ,  $V_{BATT} = 7.4V$ ,  $I_{CC} = 3A$ ,  $T_A = 25^{\circ}C$ , unless otherwise noted.

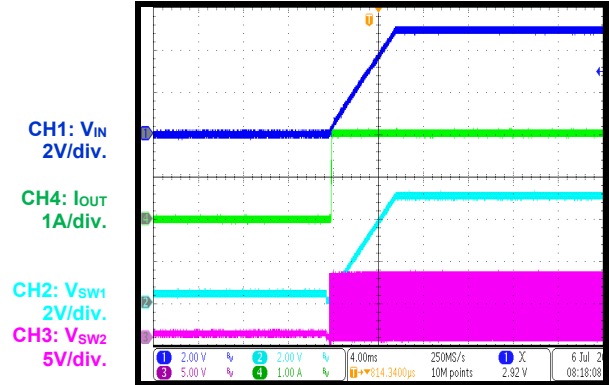
#### Charge Profile

$V_{IN} = 20V$ ,  $V_{BATT\_REG} = 8.4V$



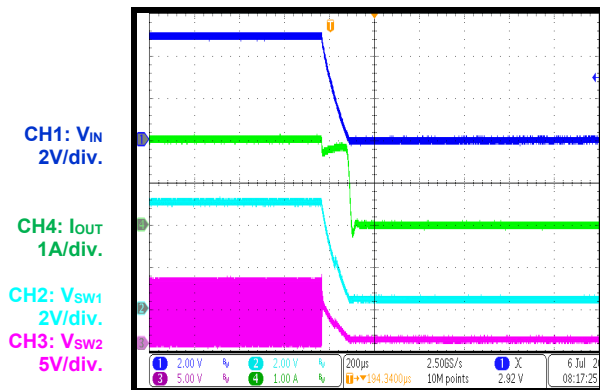
#### Source Mode Enabled

$V_{IN\_SRC} = 5V$ ,  $I_{IN\_SRC} = 2A$  (CC load).



#### Source Mode Disabled

$V_{IN\_SRC} = 5V$ ,  $I_{IN\_SRC} = 2A$  (CC load).





## PCB LAYOUT

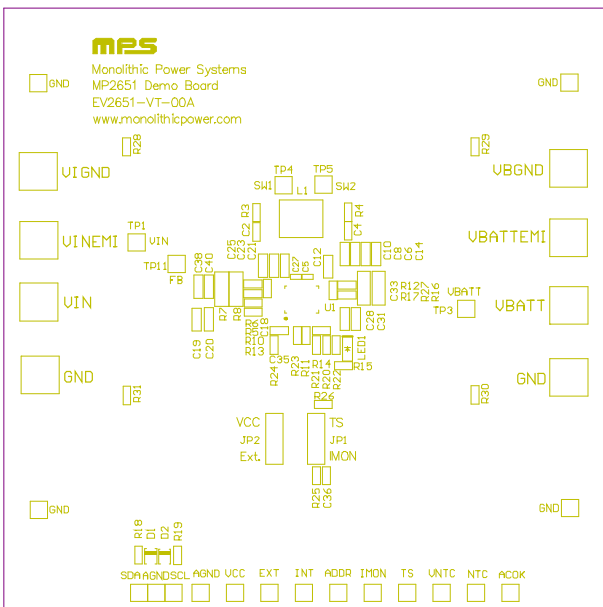


Figure 25: Top Silk

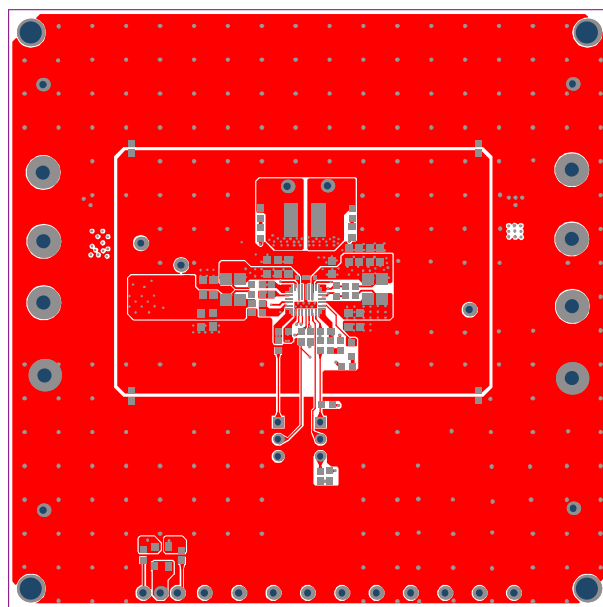


Figure 26: Top Layer

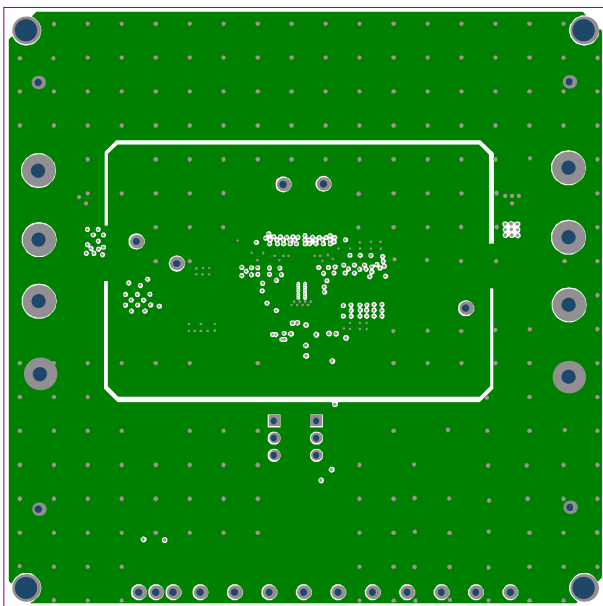


Figure 27: Mid-Layer 1

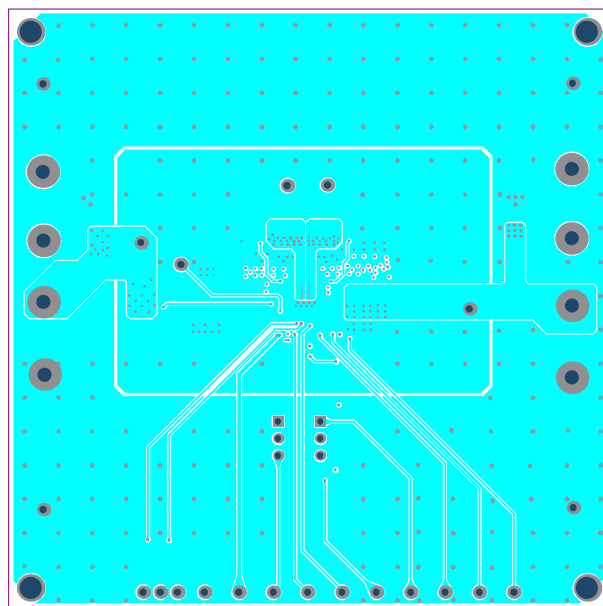


Figure 28: Mid-Layer 2

PCB LAYOUT (continued)

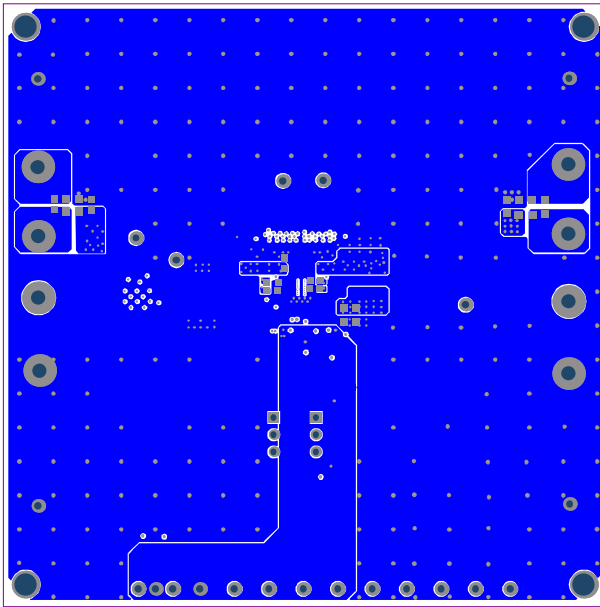


Figure 29: Bottom Layer



Figure 30: Bottom Silk

**REVISION HISTORY**

Revision #	Revision Date	Description	Pages Updated
1.0	2/15/2022	Initial Release	-
1.1	1/26/2024	Updated the MPS IC Number from MP2651GVT-0000 to MP2651GVT-000A.	2
		Updated the following in Figure 24 to be consistent with the EVB images and BOM: <ul style="list-style-type: none"> <li>• C25 = 10<math>\mu</math>F</li> <li>• R14 = 10k<math>\Omega</math></li> <li>• R20 = 0<math>\Omega</math></li> <li>• Updated the VBEMI connector to VBATTEMI</li> <li>• Updated the PGND connectors to GND</li> <li>• Updated FB to TP11</li> <li>• Updated TP2 to ADDR</li> <li>• Added the test points, TP4 (SW1) and TP5 (SW2)</li> <li>• Removed the ACGATE test point</li> <li>• Added R28 = R29 = R30 = R31 = NC</li> </ul>	12
		Updated GND (4) to TP6 (GND), TP7 (GND), TP8 (GND), and TP9 (GND), and updated the MP2651's manufacturer PN from MP2651GVT-0000 to MP2651GVT-000A in the EV2651-VT-00A Bill of Materials section.	13

**Notice:** The information in this document is subject to change without notice. Please contact MPS for current specifications. Users should warrant and guarantee that third-party Intellectual Property rights are not infringed upon when integrating MPS products into any application. MPS will not assume any legal responsibility for any said applications.