

- ▼ Capable of 1.2V Low Gate Drive
- ▼ Lower Gate Charge
- ▼ Fast Switching Performance
- ▼ RoHS Compliant & Halogen-Free

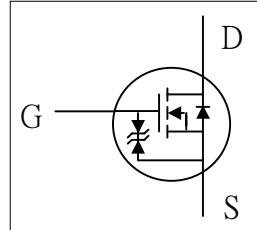

BV_{DSS}	20V
$R_{DS(ON)}$	1.2 Ω
I_D	200mA
HBM ESD	2KV

Description

XP2N1K2E series are innovated design and silicon process technology to achieve the lowest possible on-resistance and fast switching performance. It provides the designer with an extreme efficient device for use in a wide range of power applications.

The SOT-723 Package with very small footprint is suitable for all commercial-industrial surface mount application.

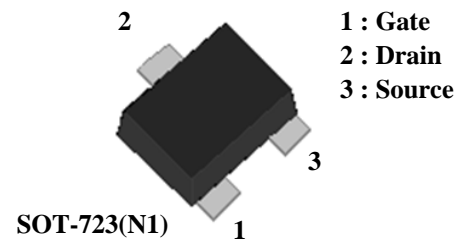

Absolute Maximum Ratings @ $T_J=25^\circ\text{C}$ (unless otherwise specified)

Symbol	Parameter	Rating	Units
V_{DS}	Drain-Source Voltage	20	V
V_{GS}	Gate-Source Voltage	± 8	V
$I_D @ T_A=25^\circ\text{C}$	Drain Current ³ , V_{GS} @ 2.5V	200	mA
I_{DM}	Pulsed Drain Current ¹	400	mA
$I_S @ T_A=25^\circ\text{C}$	Source Current (Body Diode)	125	mA
I_{SM}	Pulsed Source Current ¹ (Body Diode)	800	mA
$P_D @ T_A=25^\circ\text{C}$	Total Power Dissipation	0.15	W
T_{STG}	Storage Temperature Range	-55 to 150	$^\circ\text{C}$
T_J	Operating Junction Temperature Range	-55 to 150	$^\circ\text{C}$

Thermal Data

Symbol	Parameter	Value	Unit
Rthj-a	Maximum Thermal Resistance, Junction-ambient ³	833	$^\circ\text{C}/\text{W}$

Electrical Characteristics @T_j=25°C(unless otherwise specified)

Symbol	Parameter	Test Conditions	Min.	Typ.	Max.	Units
BV _{DSS}	Drain-Source Breakdown Voltage	V _{GS} =0V, I _D =250uA	20	-	-	V
R _{DS(ON)}	Static Drain-Source On-Resistance ²	V _{GS} =2.5V, I _D =200mA	-	-	1.2	Ω
		V _{GS} =1.8V, I _D =200mA	-	-	1.4	Ω
		V _{GS} =1.5V, I _D =40mA	-	-	2.4	Ω
		V _{GS} =1.2V, I _D =20mA	-	-	4.8	Ω
V _{GS(th)}	Gate Threshold Voltage	V _{DS} =V _{GS} , I _D =1mA	0.3	-	1	V
g _{fs}	Forward Transconductance	V _{DS} =10V, I _D =200mA	-	1.8	-	S
I _{DSS}	Drain-Source Leakage Current	V _{DS} =16V, V _{GS} =0V	-	-	10	uA
I _{GSS}	Gate-Source Leakage	V _{GS} =±8V, V _{DS} =0V	-	-	±30	uA
Q _g	Total Gate Charge	I _D =200mA	-	0.7	-	nC
Q _{gs}	Gate-Source Charge	V _{DS} =10V	-	0.2	-	nC
Q _{gd}	Gate-Drain ("Miller") Charge	V _{GS} =2.5V	-	0.2	-	nC
t _{d(on)}	Turn-on Delay Time	V _{DS} =10V	-	2	-	ns
t _r	Rise Time	I _D =150mA	-	10	-	ns
t _{d(off)}	Turn-off Delay Time	R _G =10Ω	-	30	-	ns
t _f	Fall Time	V _{GS} =5V	-	16	-	ns
C _{iss}	Input Capacitance	V _{GS} =0V	-	44	-	pF
C _{oss}	Output Capacitance	V _{DS} =10V	-	14	-	pF
C _{riss}	Reverse Transfer Capacitance	f=1.0MHz	-	10	-	pF

Source-Drain Diode

Symbol	Parameter	Test Conditions	Min.	Typ.	Max.	Units
V _{SD}	Forward On Voltage ²	I _S =0.13A, V _{GS} =0V	-	-	1.2	V

Notes:

- 1.Pulse width limited by Max. junction temperature.
- 2.Pulse test
- 3.Surface mounted on min. copper pad of FR4 board

THIS PRODUCT IS SENSITIVE TO ELECTROSTATIC DISCHARGE, PLEASE HANDLE WITH CAUTION.

USE OF THIS PRODUCT AS A CRITICAL COMPONENT IN LIFE SUPPORT OR OTHER SIMILAR SYSTEMS IS NOT AUTHORIZED.

XSEMI DOES NOT ASSUME ANY LIABILITY ARISING OUT OF THE APPLICATION OR USE OF ANY PRODUCT OR CIRCUIT DESCRIBED HEREIN; NEITHER DOES IT CONVEY ANY LICENSE UNDER ITS PATENT RIGHTS, NOR THE RIGHTS OF OTHERS.

XSEMI RESERVES THE RIGHT TO MAKE CHANGES WITHOUT FURTHER NOTICE TO ANY PRODUCTS HEREIN TO IMPROVE RELIABILITY, FUNCTION OR DESIGN.

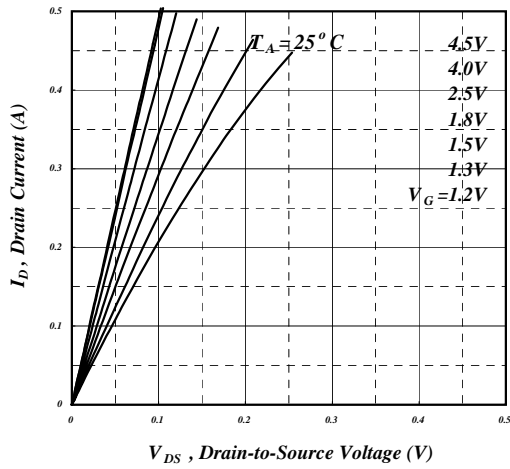

Fig 1. Typical Output Characteristics

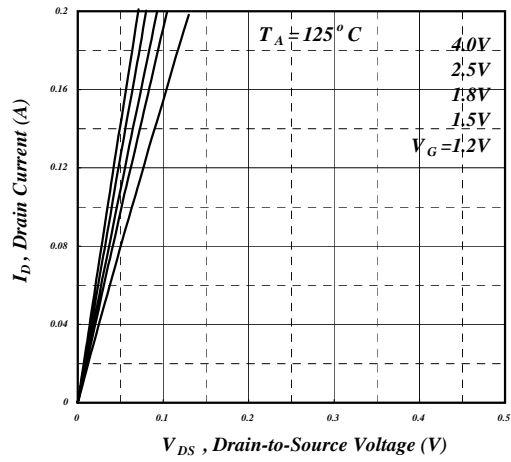

Fig 2. Typical Output Characteristics

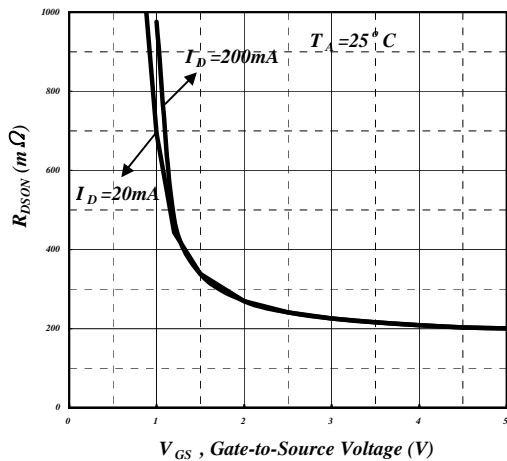

Fig 3. On-Resistance v.s. Gate Voltage

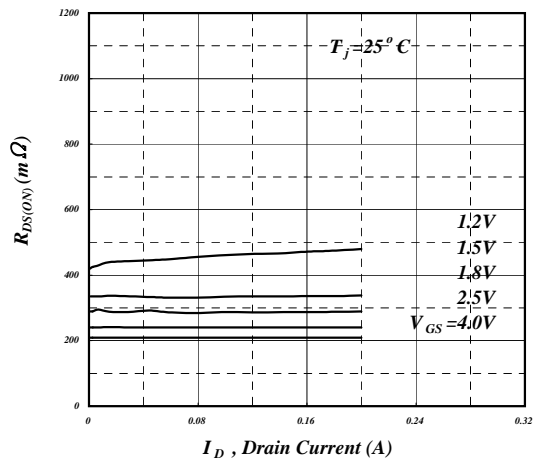

Fig 4. Typ. Drain-Source on State Resistance

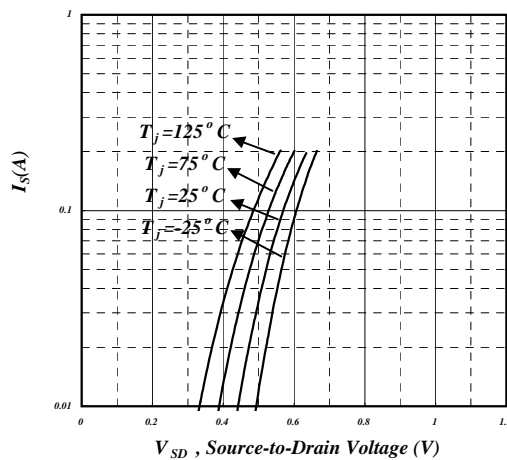

Fig 5. Forward Characteristic of Reverse Diode

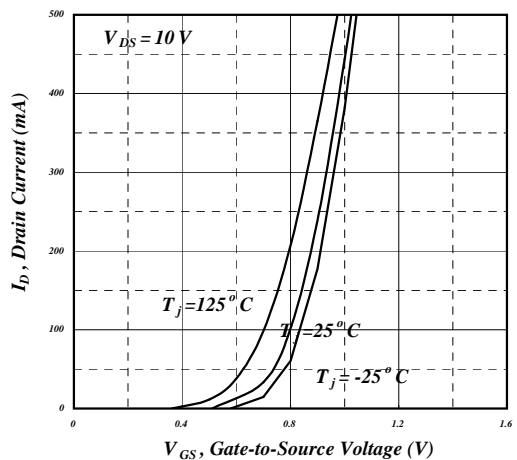

Fig 6. Transfer Characteristics

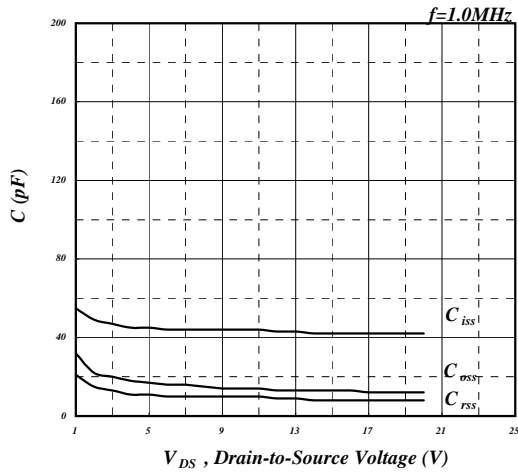

Fig 7. Typical Capacitance Characteristics

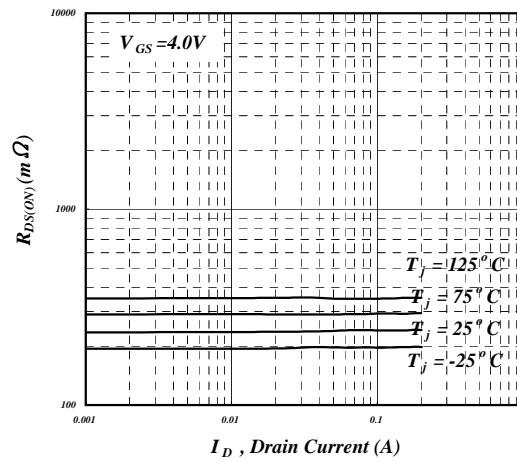

Fig 8. Static Drain-Source On-State Resistance vs. Drain Current

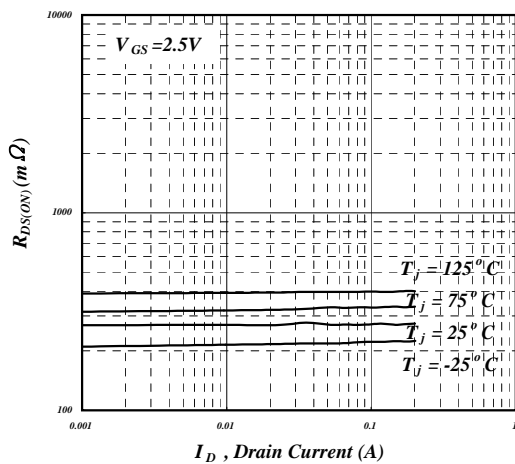

Fig 9. Static Drain-Source On-State Resistance vs. Drain Current

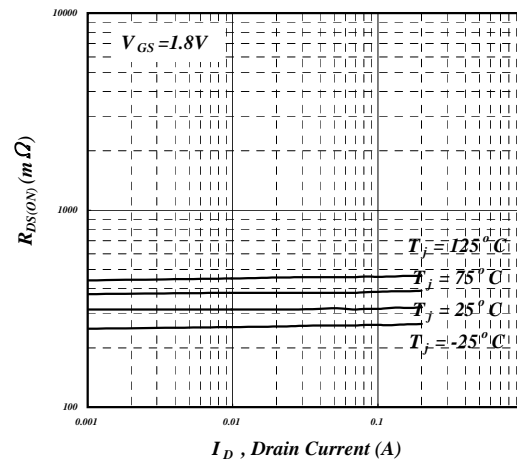

Fig 10. Static Drain-Source On-State Resistance vs. Drain Current

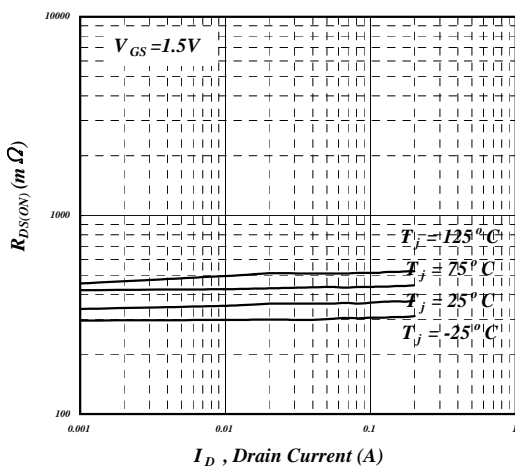

Fig 11. Static Drain-Source On-State Resistance vs. Drain Current

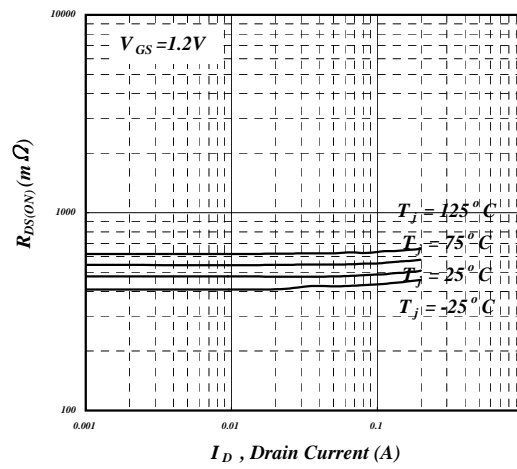
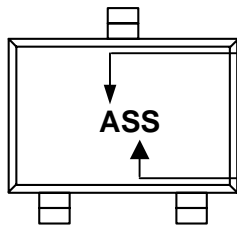

Fig 12. Static Drain-Source On-State Resistance vs. Drain Current

MARKING INFORMATION



Part Number : A

Date Code : SS

SS:2004,2008,2012,2016,2020,2024...

SS:2003,2007,2011,2015,2019,2023...

SS:2002,2006,2010,2014,2018,2022...

SS:2001,2005,2009,2013,2017,2021...

Package Outline : SOT-723

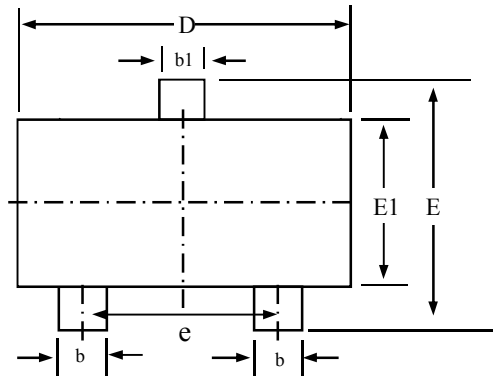

SYMBOLS	Millimeters		
	MIN	NOM	MAX
A	0.34	0.44	0.54
A1	0.00	0.03	0.05
b	0.17	0.22	0.27
b1	0.22	0.30	0.37
c	0.01	0.08	0.15
D	1.10	1.20	1.30
E	1.10	1.20	1.30
E1	0.70	0.80	0.90
e	0.80 (Typ)		
θ	7° (ref.)		

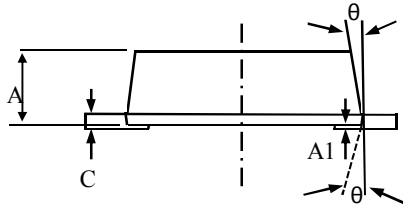

- 1.All Dimension Are In Millimeters.
- 2.Dimension Does Not Include Mold Protrusions.

SOT-723 FOOTPRINT :

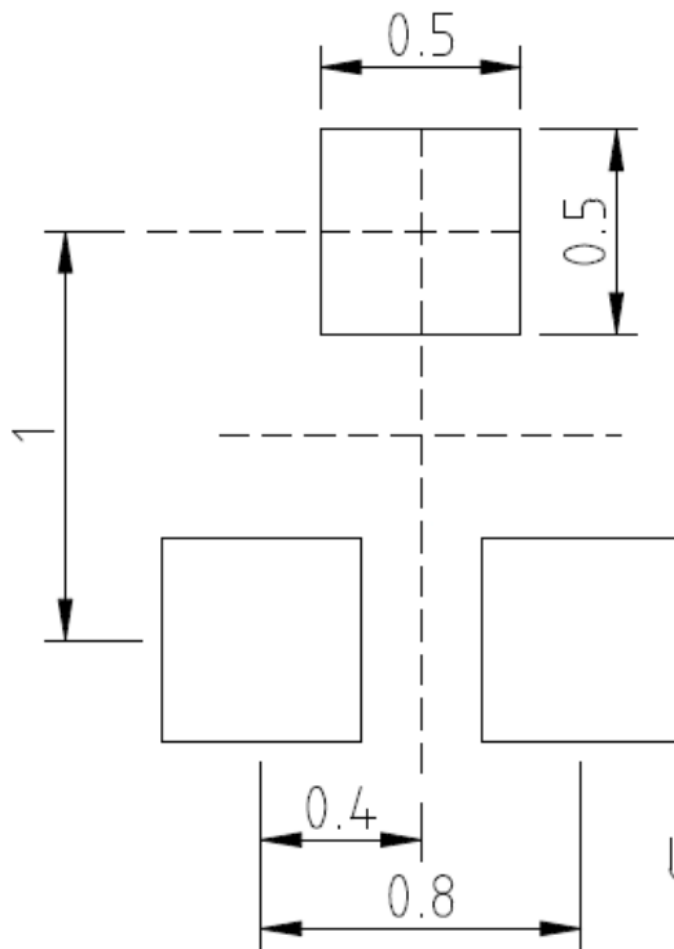

UNIT: mm