



EVERLIGHT ELECTRONICS CO.,LTD.

Device Number : DLE-033-762 REV: 1.0

T-1 3/4 (5mm) Round Shape LEDs

MODEL NO : 333-2SURC/S400-A6 ECN : _____ Page: 1/4

■ Features :

- Popular T-1 3/4 diameter package.
- Choice of various viewing angles.
- Available on tape and reel.
- Reliable and robust.

■ Description :

- The series is specially designs for applications require higher brightness than that achievable with standard lamp.
- The LED lamps are available with different colors,intensities, epoxy colors, etc.

■ Package Dimension:

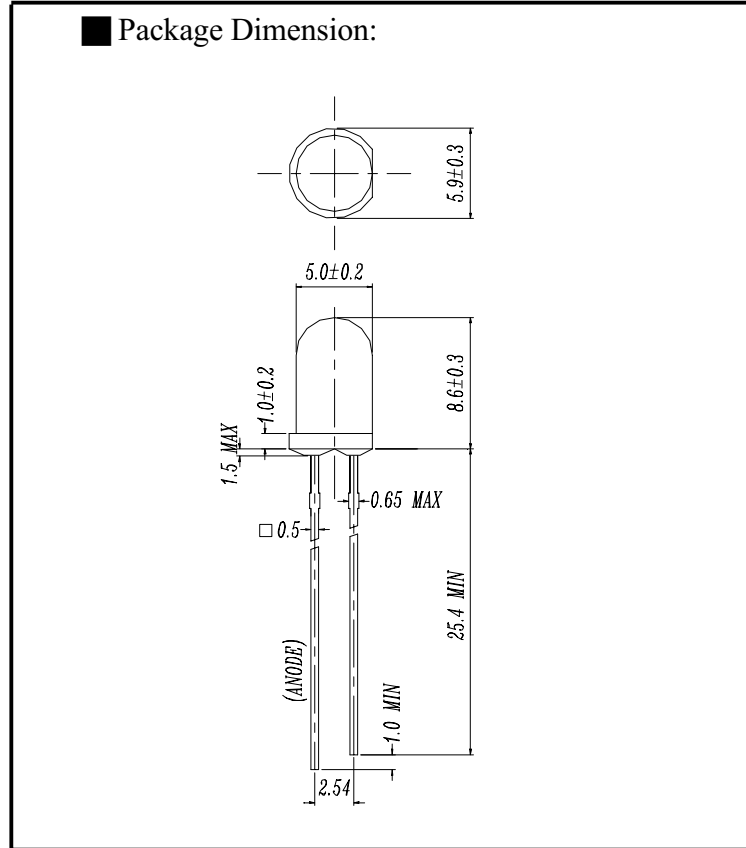

■ Applications :

- TV Set
- Monitor
- Telephone
- Computer

■ NOTES :

- 1.All dimensions are in millimeters.
- 2.An epoxy meniscus may extend about 1.5mm(0.059") down to the lead.

| PART NO | CHIP | | Lens Color |
|-------------------|----------|---------------|-------------|
| | Material | Emitted Color | |
| 333-2SURC/S400-A6 | AlGaInP | Hyper Red | Water Clear |

| DESIGNER | CHECKER | APPROVER |
|----------|---------|----------|
| | | |

Office : NO 25,Lane 76,Chung Yang Rd,Sec.3
Tucheng,Taipei 236,Taiwan,R.O.C.

TEL : 886-2-2267-2000,2267-9936(22 Lines)
FAX : 886-2-2267-6189



EVERLIGHT ELECTRONICS CO.,LTD.

Device Number : DLE-033-762 REV: 1.0

T-1 3/4 (5mm) Round Shape LEDs

MODEL NO : 333-2SURC/S400-A6 ECN : _____ Page: 2/4

■ Absolute Maximum Ratings at $T_A = 25^\circ\text{C}$

| Parameter | Symbol | Rating | Unit |
|--|----------|-------------|------------------|
| Forward Current | If | 50 | mA |
| Operating Temperature | Topr | -40 to +85 | $^\circ\text{C}$ |
| Storage Temperature | Tstg | -40 to +100 | $^\circ\text{C}$ |
| Soldering Temperature | Tsol | 260 ± 5 | $^\circ\text{C}$ |
| Power Dissipation | Pd | 120 | mW |
| Peak Forward Current(Duty 1/10 @ 1KHZ) | If(Peak) | 200 | mA |
| Reverse voltage | Vr | 5 | V |

■ Electronic Optical Characteristics :

| Parameter | Symbol | MIN. | TYP. | MAX. | Unit | Condition |
|------------------------------|-----------------|--------------|-------------|------|---------------|-------------------|
| Luminous intensity | Iv | ---- 1810 | 186 3100 | --- | mcd | If=2mA If=20mA |
| Viewing Angle | 2θ 1/2 | ---- | 10 | ---- | deg | If=20mA |
| Peak Wavelength | λ_p | ---- | 632 | ---- | nm | If=20mA |
| Dominant Wavelength | λ_d | ---- | 624 | ---- | nm | If=20mA |
| Spectrum Radiation Bandwidth | $\Delta\lambda$ | ---- | 20 | ---- | nm | If=20mA |
| Forward Voltage | Vf | ---- | 2.0 | 2.4 | V | If=20mA |
| Reverse Current | Ir | ---- | ---- | 10 | μA | Vr=5V |

ESD:2000V



EVERLIGHT ELECTRONICS CO.,LTD.

Device Number : DLE-033-762 REV: 1.0

T-1 3/4 (5mm) Round Shape LEDs

MODEL NO 333-2SURC/S400-A6 ECN : _____ Page: 3/4

■ Typical Electro-Optical Characteristic Curves

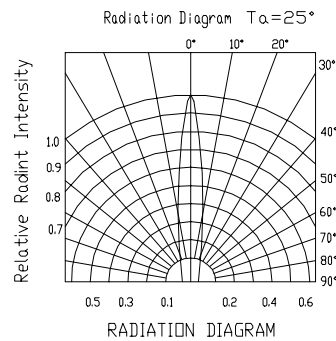
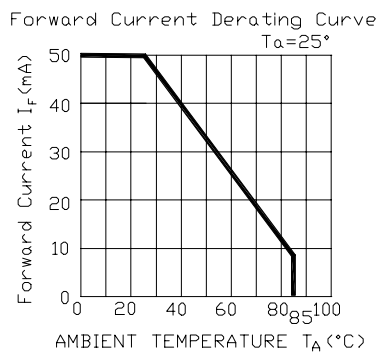
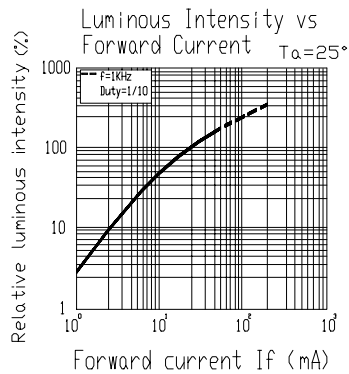
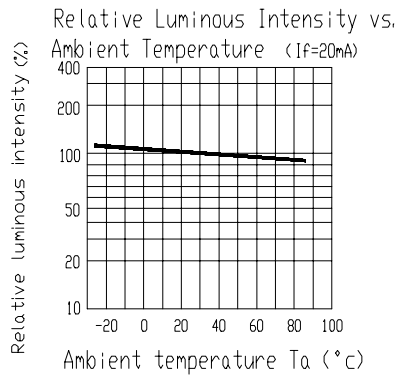
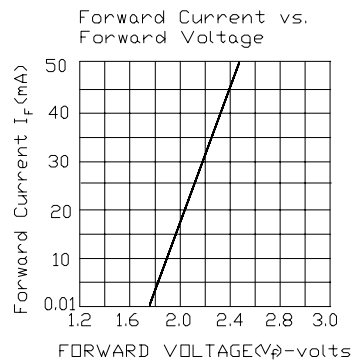
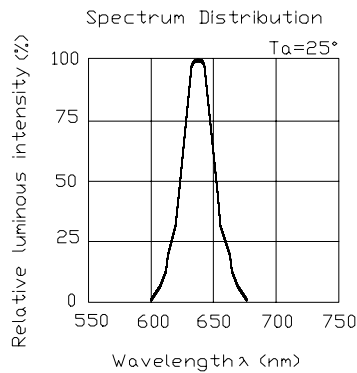



EVERLIGHT ELECTRONICS CO.,LTD.

Device Number : DLE-033-762 REV: 1.0

T-1 3/4 (5mm) Round Shape LEDs

MODEL NO 333-2SURC/S400-A6 ECN : _____ Page: 4/4

■ Reliability test items and conditions

| NO | Item | Test Conditions | Test Hours/Cycle | Sample Size | Ac/Re |
|----|----------------------------------|---|------------------|-------------|-------|
| 1 | Soldering Heat | TEMP : 260°C ± 5 °C | 10±1 SEC | 76 Pcs | 0/1 |
| 2 | Solderability | TEMP : 230°C ± 5 °C | 5±1 SEC | 76 Pcs | 0/1 |
| 3 | Temperature Cycle | H : +85°C 30min ∫ 5 min L : -55°C 30min | 50 CYCLE | 76 Pcs | 0/1 |
| 4 | Thermal Shock | H : +100°C 5min ∫ 10 sec L : -10°C 5min | 50 CYCLE | 76 Pcs | 0/1 |
| 5 | High Temperature Storage | TEMP : 100°C | 1000 HRS | 76 Pcs | 0/1 |
| 6 | Low Temperature Storage | TEMP : -55°C | 1000 HRS | 76 Pcs | 0/1 |
| 7 | DC Operating Life | If = 20 mA | 1000 HRS | 76 Pcs | 0/1 |
| 8 | High Temperature / High Humidity | 85°C/85% RH | 1000 HRS | 76 Pcs | 0/1 |