

Support Legs

22593.2195



Product Description

The support legs are universally usable as adjustable legs. The plate is screwed to the threaded pin and nut by a stainless steel fastening screw, and is also glued.

Material

Grub Screw

- Stainless steel 1.4305

Lock nut

- Stainless Steel A2, ISO 4032

Pad

- Stainless steel 1.4301, vibratory ground

More information

Further products

- Support Legs, protected against slipping

Drawing

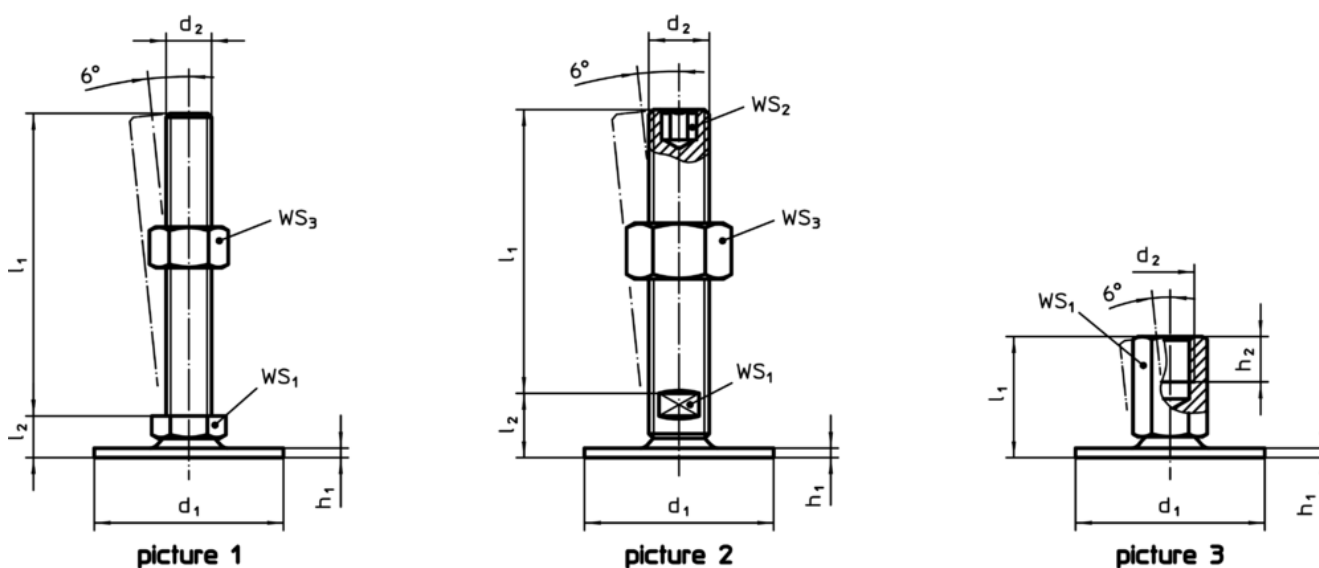

Order information

Dimensions		WS ₁	WS ₂	WS ₃		Art. No.
d ₁	d ₂	l ₁	h ₁	l ₂	[g]	
[mm]		[mm]	[mm]	[mm]		
with screw – picture 2, stainless steel						
80	M16	150	3	18	349	22593.2195

Compliance

RoHS compliant

Compliant according to Directive 2011/65/EU and Directive 2015/863

Does not contain SVHC substances

No SVHC substances with more than 0.1% w/w contained - SVHC list [REACH] as of 10.06.2022

Does not contain Proposition 65 substances

No Proposition 65 substances included

<https://www.P65Warnings.ca.gov/>

Free from Conflict Minerals

This product does not contain any substances designated as "conflict minerals" such as tantalum, tin, gold or tungsten from the Democratic Republic of Congo or adjacent countries.