

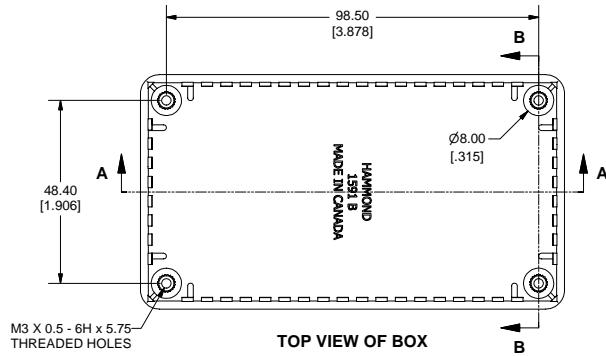

SIDE VIEW OF BOX

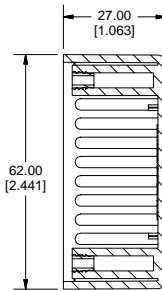

TOP VIEW OF BOX



SECTION B-B  
SCALE 1 : 1

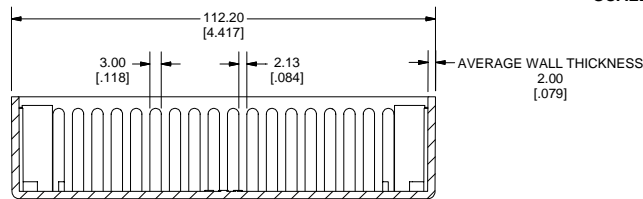

SECTION A-A  
SCALE 1 : 1



SIDE OF LID

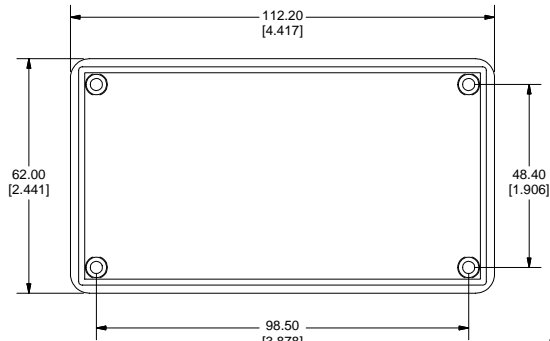

BOTTOM OF LID

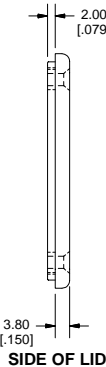

SIDE OF LID

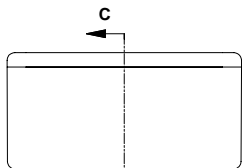

END VIEW OF ASSEMBLY

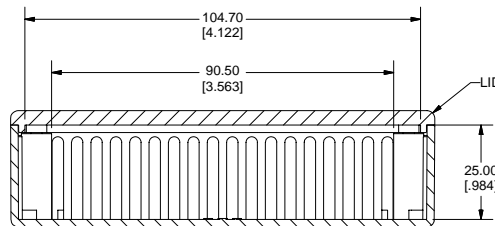

SECTION C-C  
SCALE 1 : 1

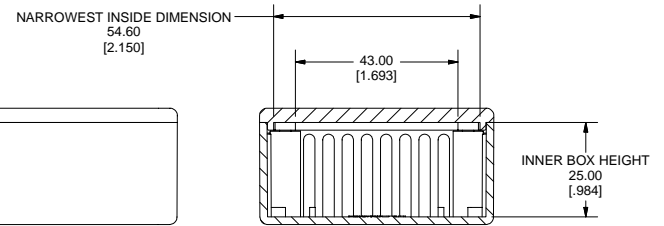

SECTION D-D  
SCALE 1 : 1

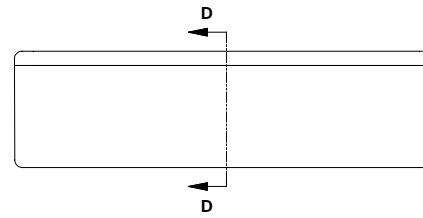

SIDE VIEW OF ASSEMBLY

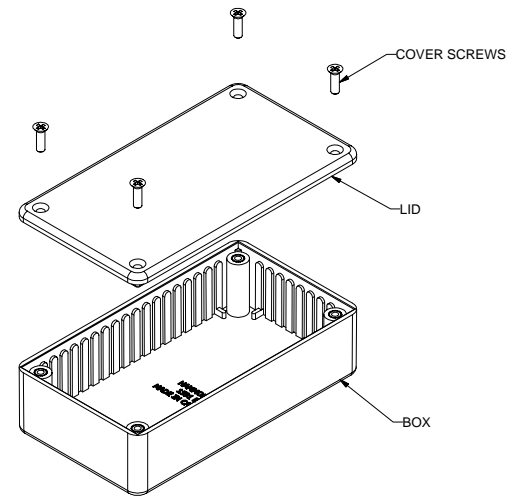

# 1591B

PART NUMBERS				
1591B Enclosures				
Material	Colour	Part Number		
ABS	Beige	1591BBC		
	Black	1591BSK		
	Blue	1591BBU		
	Grey	1591BGY		
	Black Shielded	1591RBBK		
GP ABS	Black	1591BSBK		
Translucent Polycarbonate	Ice Blue	1591BTBU		
	IR Red	1591BTRD		
	Crystal Clear	1591BTCL		
Accessories				
Description	Part Number			
Used with ABS and Translucent Polycarbonate Enclosures	PC Board Card Adapters	See Accessories Section		
	Flange Kits	See Accessories Section		
	Replacement Screws, nickel plated M3 - 0.5 x 10mm, Pack of 100,	1591MS100		
	Belt/Pocket Clip, w/ nylon screws (insulated to avoid interference) and mounting template	1599CLIP - Black 1599CLIPGY - Grey		
	Clear Lids - clear, flame retardant polycarbonate - Lid ONLY	1591BC		
	Used with GP ABS Enclosure	PC Board Card Adapters	See Accessories Section	
		Flange Kits	See Accessories Section	
		Belt/Pocket Clip, w/ nylon screws (insulated to avoid interference) and mounting template	1599CLIP - Black 1599CLIPGY - Grey	
		Replacement Screws, self tapping, black oxide, #4 x 0.5, Pack of 100	1591TS100BK	
	Clear Lids - clear, flame retardant polycarbonate - Lid ONLY	1591BC		
Required Torque on Fasteners (no lubrication)				
M3 - 0.5 x 10mm Screws	30-40 cN*m			
#4 x 0.5 Screws	30-40 cN*m			



www.hammondmfg.com