



POWER SUPPLY

- 100-240V Wide Range Input
- NEC Class 2 Compliant
- Adjustable Output Voltage
- Efficiency up to 77.2%
- Compact Design, Width only 22.5mm
- Full Output Power Between -10°C and +60°C
- Large International Approval Package
- 3 Year Warranty

GENERAL DESCRIPTION

A compact size, light weight, simple mounting onto the DIN-rail and the utilization of only quality components are what makes the MiniLine power supplies so easy to use and install within seconds.

A rugged electrical and mechanical design as well as a high immunity against electrical disturbances on the mains provides reliable output power. This offers superior protection for equipment which is connected to the public mains network or is exposed to a critical industrial environment.

The MiniLine series offers output voltages from 5 to 56Vdc and a power rating from 15W to 100W.

The supplementary MiniLine decoupling diode module MLY02.100 allows building of redundant systems or to protect against back-feed voltages.

ML15

Related products

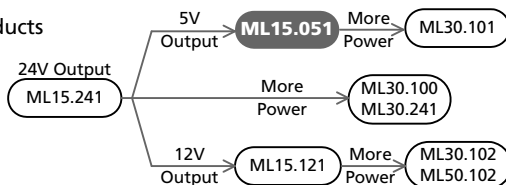

SHORT-FORM DATA

Output voltage	DC 5V	
Adjustment range	5 – 5.5V	
Output current	3A at 5V	
Output power	15W	
Output ripple	< 50mVpp	20Hz to 20MHz
Input voltage	AC 100-240V	wide-range input
Mains frequency	50-60Hz	±6%
AC Input current	0.28 / 0.17A	at 120 / 230Vac
Power factor	0.51 / 0.44	at 120 / 230Vac
AC Inrush current	typ. 16 / 31A	peak value at 120/230Vac, 40°C and cold start
DC Input	85-375Vdc	
Efficiency	76.8 / 77.2%	at 120 / 230Vac
Losses	4.6 / 4.5W	at 120 / 230Vac
Temperature range	-10°C to +70°C	operational
Derating	0.4W/°C	+60 to +70°C
Hold-up time	typ. 45 / 186ms	at 120 / 230Vac
Dimensions	22.5x75x91mm	WxHxD

ORDER NUMBERS

Power Supply **ML15.051** 5V Standard unit

MARKINGS



INDEX

	Page		Page
1. Intended Use	3	18. Approvals	14
2. Installation Requirements.....	3	19. Fulfilled Standards.....	14
3. AC-Input.....	4	20. Used Substances	14
4. DC-Input.....	5	21. Physical Dimensions and Weight	15
5. Input Inrush Current	5	22. Application Notes	16
6. Output	6	22.1. Peak Current Capability	16
7. Hold-up Time.....	7	22.2. Back-feeding Loads	16
8. Efficiency and Power Losses.....	8	22.3. External Input Protection.....	17
9. Functional Diagram.....	9	22.4. Parallel Use to Increase Output Power....	17
10. Front Side and User Elements.....	9	22.5. Parallel Use for Redundancy.....	18
11. Terminals and Wiring.....	10	22.6. Series Operation	18
12. Reliability.....	10	22.7. Inductive and Capacitive Loads.....	18
13. EMC.....	11	22.8. Operation on Two Phases	19
14. Environment	12	22.9. Use Without PE on the Input	19
15. Protection Features	12	22.10. Use in a Tightly Sealed Enclosure	20
16. Safety Features.....	13	22.11. Mounting Orientations	21
17. Dielectric Strength	13		

The information presented in this document is believed to be accurate and reliable and may change without notice.

The housing is patent by PULS (US patent No US D442,923S)

No part of this document may be reproduced or utilized in any form without permission in writing from the publisher.

TERMINOLOGY AND ABBREVIATIONS

PE and \oplus symbol	PE is the abbreviation for Protective Earth and has the same meaning as the symbol \oplus .
Earth, Ground	This document uses the term "earth" which is the same as the U.S. term "ground".
T.b.d.	To be defined, value or description will follow later.
AC 230V	A figure displayed with the AC or DC before the value represents a nominal voltage with standard tolerances (usually $\pm 15\%$) included. E.g.: DC 12V describes a 12V battery disregarding whether it is full (13.7V) or flat (10V)
230Vac	A figure with the unit (Vac) at the end is a momentary figure without any additional tolerances included.
50Hz vs. 60Hz	As long as not otherwise stated, AC 100V and AC 230V parameters are valid at 50Hz and AC 120V parameters are valid at 60Hz mains frequency.

1. INTENDED USE

This device is designed for installation in an enclosure and is intended for the general use such as in industrial control, office, communication, and instrumentation equipment.

Do not use this power supply in aircrafts, trains and nuclear equipment where malfunction may cause severe personal injury or threaten human life.

This device is designed for use in hazardous, non-hazardous, ordinary or unclassified locations.

2. INSTALLATION REQUIREMENTS

This device may only be installed and put into operation by qualified personnel.

This device does not contain serviceable parts. The tripping of an internal fuse is caused by an internal defect.

If damage or malfunction should occur during installation or operation, immediately turn power off and send unit to the factory for inspection.

Mount the unit on a DIN-rail so that the output terminals are located on top and input terminal on the bottom. For other mounting orientations see de-rating requirements in this document.

This device is designed for convection cooling and does not require an external fan. Do not obstruct airflow and do not cover ventilation grid (e.g. cable conduits) by more than 30%!

Keep the following installation clearances:

40mm on top, 20mm on the bottom

15mm on the left or right sides in case the adjacent device is a heat source (e.g. another power supply).

⚠ WARNING Risk of electrical shock, fire, personal injury or death.

- Do not use the power supply without proper grounding (Protective Earth). Use the terminal on the input block for earth connection and not one of the screws on the housing.
- Turn power off before working on the device. Protect against inadvertent re-powering.
- Make sure that the wiring is correct by following all local and national codes.
- Do not modify or repair the unit.
- Do not open the unit as high voltages are present inside.
- Use caution to prevent any foreign objects from entering into the housing.
- Do not use in wet locations or in areas where moisture or condensation can be expected.
- Do not touch during power-on, and immediately after power-off. Hot surface may cause burns.

3. AC-INPUT

AC input	nom.	AC 100-240V	
AC input range		85-264Vac	continuous operation
		264-300Vac	< 0.5s
Allowed voltage L or N to earth	max.	300Vac	
Input frequency	nom.	50-60Hz	±6%
Turn-on voltage	typ.	59Vac	steady-state value, see Fig. 3-1
Shut-down voltage	typ.	54Vac	steady-state value, see Fig. 3-1

		AC 100V	AC 120V	AC 230V	
Input current (rms)	typ.	0.34A	0.28A	0.17A	at 5V, 3A see Fig. 3-3
Power factor *)	typ.	0.52	0.51	0.44	at 5V, 3A see Fig. 3-4
Crest factor **)	typ.	3.45	3.53	3.94	at 5V, 3A
Start-up delay	typ.	630ms	630ms	630ms	see Fig. 5 2
Rise time	typ.	10ms	10ms	10ms	at 5V, 3A, see Fig. 3-2
Turn-on overshoot	max.	100mV	100mV	100mV	see Fig. 3-2

*) The power factor is the ratio of the true (or real) power to the apparent power in an AC circuit.

**) The crest factor is the mathematical ratio of the peak value to RMS value of the input current waveform.

Fig. 3-1 Input voltage range

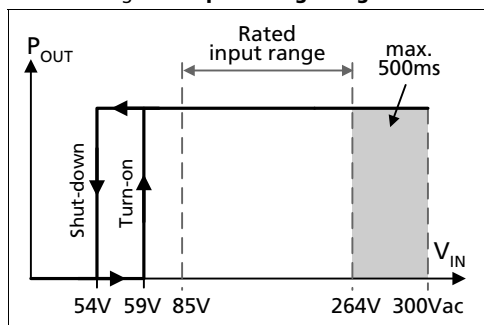

Fig. 3-2 Turn-on behavior, definitions

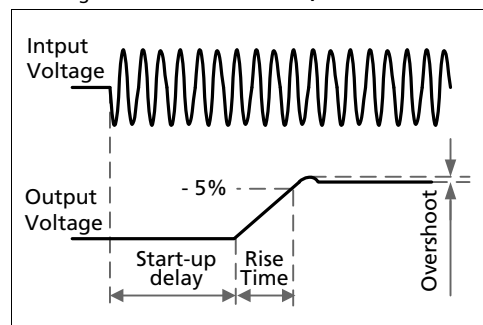

Fig. 3-3 Input current vs. output load

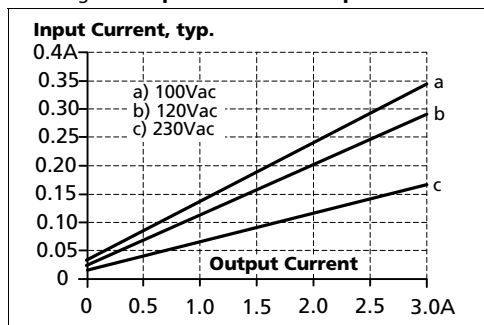
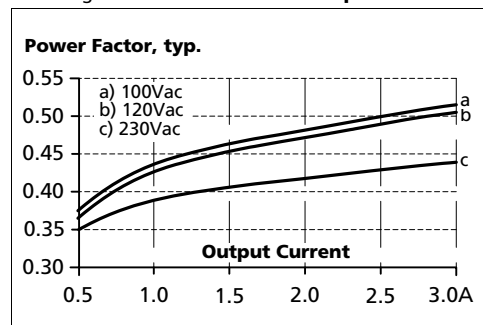

Fig. 3-4 Power factor vs. output load



4. DC-INPUT

DC input	nom.	DC 110-290V	-25% +30%
DC input range	min.	85-375Vdc	continuous operation
DC input current	typ.	0.16A / 0.057A	110Vdc / 300Vdc, at 5V, 3A
Turn-on voltage	typ.	80Vdc	steady state value
Shut-down voltage	typ.	60Vdc	steady state value

Fig. 4-1 Wiring for DC Input

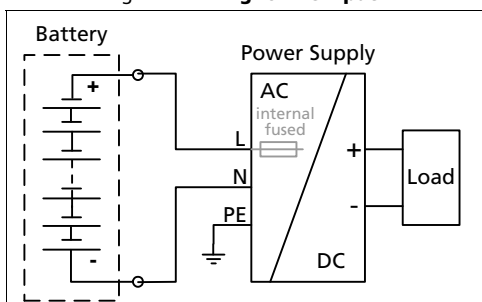

Instructions for DC use:

- Use a battery or similar DC source.
For other sources contact PULS
- Connect +pole to L and -pole to N.
- Connect the PE terminal to an earth wire or to the machine ground.

5. INPUT INRUSH CURRENT

A NTC limits the input inrush current after turn-on of the input voltage. The inrush current is input voltage and ambient temperature dependent.

The charging current into EMI suppression capacitors is disregarded in the first microseconds after switch-on.

		AC 100V	AC 120V	AC 230V	
Inrush current	max.	13A _{peak}	16A _{peak}	31A _{peak}	40°C ambient, cold start
	typ.	11A _{peak}	13A _{peak}	26A _{peak}	40°C ambient, cold start
Inrush energy	max.	0.1A ² s	0.1A ² s	0.4A ² s	40°C ambient, cold start

Fig. 5-1 Input inrush current, typical behavior

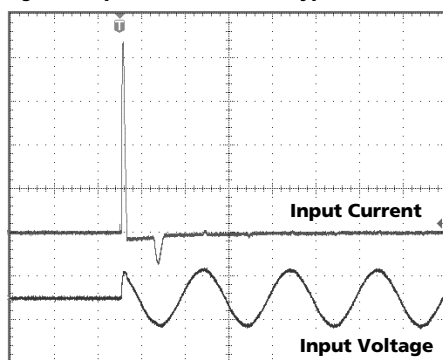

Input: 230Vac
 Output: 5V, 3A
 Ambient: 25°C
 Upper curve: Input current 5A/DIV
 Lower curve: Input voltage 500V/DIV
 Time basis: 10ms / DIV

Fig. 5-2 Input inrush current, zoom into first peak

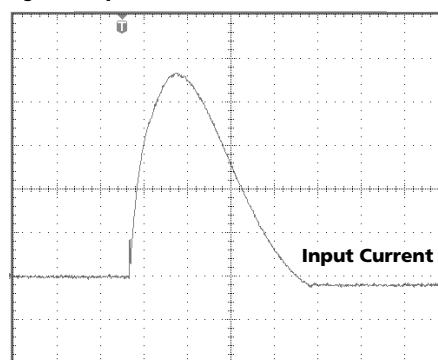

Input: 230Vac
 Output: 5V, 3A
 Ambient: 25°C
 Input current curve: 5A/DIV, 500µs / DIV
I_{peak} 23A

6. OUTPUT

Output voltage	nom.	5V	
Adjustment range	min.	5-5.5V	guaranteed
	max.	6V	at clockwise end position of potentiometer
Factory setting		5.1V	±0.2%, at full load, cold unit
Line regulation	max.	10mV	85-264Vac
Load regulation	max.	100mV	static value, 0A → 3A
Ripple and noise voltage	max.	50mVpp	20Hz to 20MHz, 50Ohm
Output capacitance	typ.	4 800µF	
Output current	nom.	3A	at 5V, see Fig. 6-1
	nom.	2.72A	at 5.5V, see Fig. 6-1
Output power	nom.	15W	
Short-circuit current	min.	hiccup mode, see Fig. 6-2	
	max.	hiccup mode, see Fig. 6-2	

Fig. 6-1 **Output voltage vs. output current, typ.**

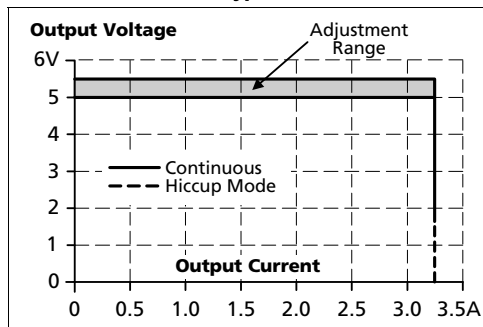
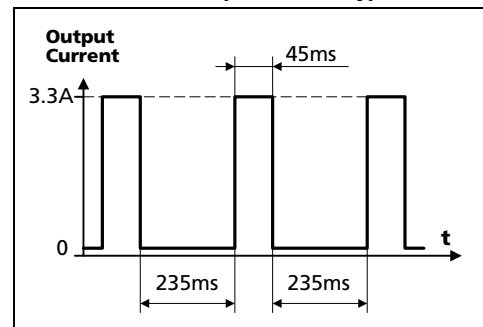

Fig. 6-2 **Hiccup mode; output current at shorted output, 230Vac, typ.**



Peak current capability (up to several milliseconds)

The power supply can deliver a peak current which is higher than the specified short term current. This helps to start current demanding loads or to safely operate subsequent circuit breakers.

The extra current is supplied by the output capacitors inside the power supply. During this event, the capacitors will be discharged and causes a voltage dip on the output. Detailed curves can be found in chapter 22.1.

Peak current voltage dips	typ.	from 5V to 2.4V	at 6A for 50ms, resistive load
	typ.	from 5V to 1.0V	at 15A for 2ms, resistive load
	typ.	from 5V to 0.8V	at 15A for 5ms, resistive load

7. HOLD-UP TIME

		AC 100V	AC 120V	AC 230V	
Hold-up Time	typ.	61ms	93ms	340ms	at 5V, 1.5A, see Fig. 7-1
	typ.	29.5ms	45ms	186ms	at 5V, 3A, see Fig. 7-1

Note: At no load, the hold-up time can be up to several seconds. The green DC-ok lamp is also on during this time

Fig. 7-1 Hold-up time vs. input voltage

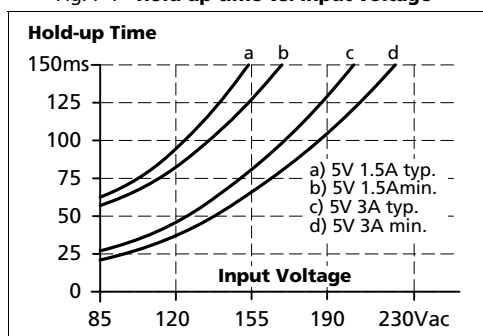
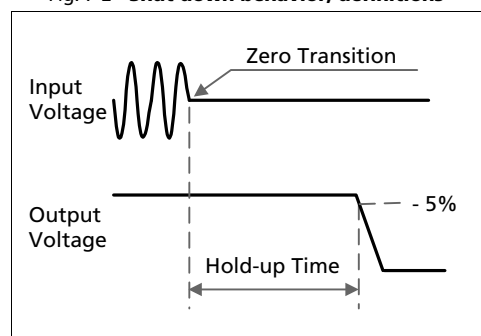

Fig. 7-2 Shut-down behavior, definitions



8. EFFICIENCY AND POWER LOSSES

		AC 100V	AC 120V	AC 230V	
Efficiency	typ.	75.8%	76.8%	77.2%	at 5V, 3A (full load)
Power losses	typ.	0.2W	0.3W	0.6W	at 0A
	typ.	2.3W	2.3W	2.4W	at 5V, 1.5A (half load)
	typ.	4.9W	4.6W	4.5W	at 5V, 3A (full load)

Fig. 8-1 Efficiency vs. output current at 5V, typ.

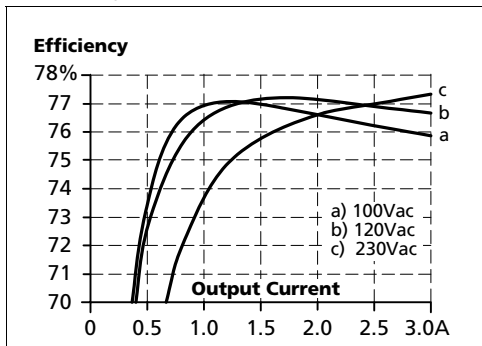

Fig. 8-2 Losses vs. output current at 5V, typ.

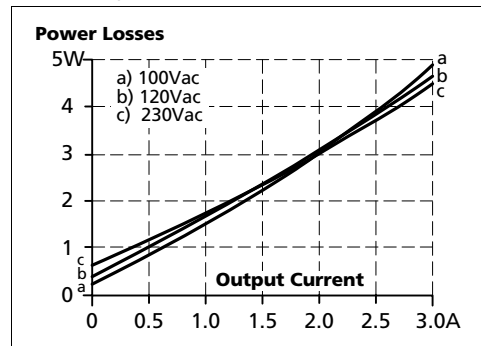

Fig. 8-3 Efficiency vs. input voltage at 5V, 3A, typ.

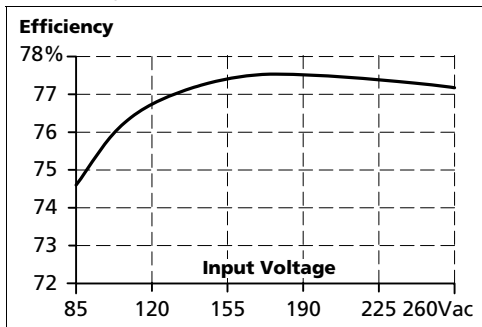
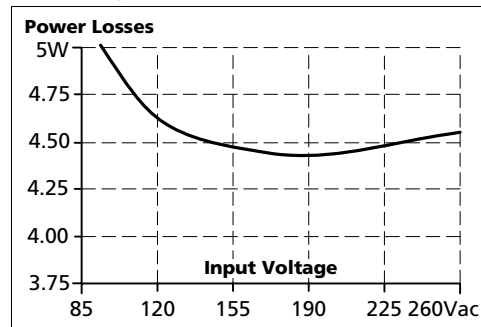
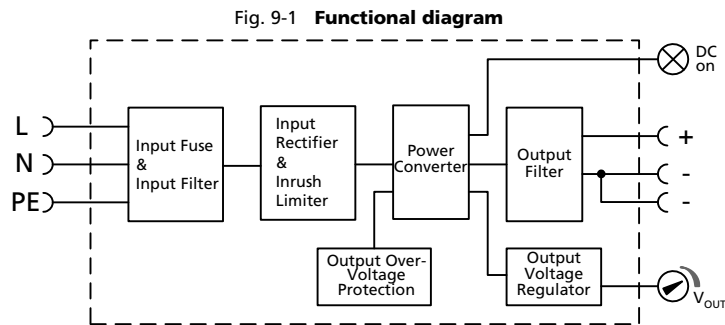

Fig. 8-4 Losses vs. input voltage at 5V, 3A, typ.



9. FUNCTIONAL DIAGRAM



10. FRONT SIDE AND USER ELEMENTS

Fig. 10-1 **Front side**



- A** Output Terminals
Screw terminals,
Dual terminals for the negative pole allows an easy earthing of the output voltage
+ Positive output
- Negative (return) output
- B** Input Terminals
Screw terminals
L Phase (Line) input
N Neutral conductor input
⊕ PE (Protective Earth) input
- C** DC-ON LED (green)
On when the voltage on the output terminals is > 2V
- D** Output voltage potentiometer
Turn to set the output voltage. Factory set: 5.1V

11. TERMINALS AND WIRING

All terminals are easy to access when mounted on the panel. Input and output terminals are separated from each other (input below, output above) to help in error-free wiring.

	Input	Output
Type	screw terminals	screw terminals
Solid wire	0.5-6mm ²	0.5-6mm ²
Stranded wire	0.5-4mm ²	0.5-4mm ²
American Wire Gauge	20-10 AWG	20-10 AWG
Wire stripping length	7mm / 0.275inch	7mm / 0.275inch
Screwdriver	3.5mm slotted or Pozidrive No 2	3.5mm slotted or Pozidrive No 2
Recommended tightening torque	1Nm, 9lb.in	1Nm, 9lb.in

Instructions:

- Use appropriate copper cables that are designed for minimum operating temperatures of: 60°C for ambient up to 45°C and 75°C for ambient up to 60°C minimum.
- Follow national installation codes and installation regulations!
- Ensure that all strands of a stranded wire enter the terminal connection!
- Up to two stranded wires with the same cross section are permitted in one connection point (except PE wire).
- Do not use the unit without PE connection.
- Screws of unused terminal compartments should be securely tightened.
- Ferrules are allowed, but not required

12. RELIABILITY

These units are extremely reliable and use only the highest quality materials. The number of critical components such as electrolytic capacitors has been reduced.

	AC 100V	AC 120V	AC 230V	
Lifetime expectancy *)	66 000h	70 000h	93 000h	at 5V, 3A and 40°C
	> 15 years	> 15 years	> 15 years	at 5V, 1.5A and 40°C
	> 15 years	> 15 years	> 15 years	at 5V, 3A and 25°C
MTBF **) SN 29500, IEC 61709	2 479 000h	2 838 000h	2 686 000h	at 5V, 3A and 40°C
	4 066 000h	4 654 000h	4 405 000h	at 5V, 3A and 25°C
MTBF **) MIL HDBK 217F	1 175 000h	1 251 000h	1 145 000h	at 5V, 3A and 40°C; Ground Benign GB40
	1 575 000h	1 676 000h	1 534 000h	at 5V, 3A and 25°C; Ground Benign GB25

*) The **Lifetime expectancy** shown in the table indicates the minimum operating hours (service life) and is determined by the lifetime expectancy of the built-in electrolytic capacitors. Lifetime expectancy is specified in operational hours and is calculated according to the capacitor's manufacturer specification. The prediction model allows only a calculation of up to 15 years from date of shipment.

) **MTBF stands for **Mean Time Between Failure**, which is calculated according to statistical device failures, and indicates reliability of a device. It is the statistical representation of the likelihood of a unit to fail and does not necessarily represent the life of a product.

13. EMC

The power supply is suitable for applications in industrial environment as well as in residential, commercial and light industry environment without any restrictions. The CE mark indicates conformance with EMC guideline 89/336/EEC, 93/68/EEC and 2004/108/EC and the low-voltage directive (LVD) 73/23/EWG and 2006/95/EC. A detailed EMC report is available on request.

EMC Immunity	Generic standards: EN 61000-6-1 and EN 61000-6-2			
Electrostatic discharge	EN 61000-4-2	Contact discharge	8kV	Criterion A
		Air discharge	8kV	Criterion A
Electromagnetic RF field	EN 61000-4-3	80MHz-2.7GHz	10V/m	Criterion A
Fast transients (Burst)	EN 61000-4-4	Input lines	4kV	Criterion A
		Output lines	2kV	Criterion A
Surge voltage on input	EN 61000-4-5	L → N	2kV	Criterion A
Surge voltage on input	EN 61000-4-5	N → PE, L → PE	4kV	Criterion A
Surge voltage on output	EN 61000-4-5	+ → -	500V	Criterion A
		+ → PE, - → PE	500V	Criterion A
Conducted disturbance	EN 61000-4-6	0.15-80MHz	10V	Criterion A
Mains voltage dips	EN 61000-4-11	0% of 100Vac	0Vac, 20ms	Criterion A
		40% of 100Vac	40Vac, 200ms	Criterion C
		70% of 100Vac	70Vac, 500ms	Criterion A
		0% of 200Vac	0Vac, 20ms	Criterion A
		40% of 200Vac	80Vac, 200ms	Criterion A
		70% of 200Vac	140Vac, 500ms	Criterion A
Voltage interruptions	EN 61000-4-11		0Vac, 5000ms	Criterion C
Input voltage swells	PULS internal standard		300Vac, 500ms	Criterion A
Powerful transients	VDE 0160	over entire load range	750V, 1.3ms	Criterion A

Criteria:

- A:** Power supply shows normal operation behavior within the defined limits.
- C:** Temporary loss of function is possible. Power supply may shut-down and restarts by itself. No damage or hazards for the power supply will occur.

EMC Emission	Generic standards: EN 61000-6-3 and EN 61000-6-4		
Conducted emission	EN 55011, EN 55022, FCC Part 15, CISPR 11, CISPR 22 EN 55022	Class B, input lines	
		Class B, output lines	
Radiated emission	EN 55011, EN 55022	Class B	
Harmonic input current	EN 61000-3-2	Not applicable, below 75W input power	
Voltage fluctuations, flicker	EN 61000-3-3	fulfilled	

This device complies with FCC Part 15 rules.

Operation is subjected to following two conditions: (1) this device may not cause harmful interference, and (2) this device must accept any interference received, including interference that may cause undesired operation.

Switching frequency	Constant, typ. 65kHz
----------------------------	----------------------

14. ENVIRONMENT

Operational temperature *)	-10°C to +70°C (14°F to 158°F)	Reduce output power according Fig. 14-1
Storage temperature	-40 to +85°C (-40°F to 185°F)	For storage and transportation
Output de-rating	0.4W/°C	60-70°C (140°F to 158°F)
Humidity **)	5 to 95% r.H.	IEC 60068-2-30
Vibration sinusoidal	2-17.8Hz: ±1.6mm; 17.8-500Hz: 2g 2 hours / axis	IEC 60068-2-6
Shock	30g 6ms, 20g 11ms 3 bumps / direction, 18 bumps in total	IEC 60068-2-27
Altitude	0 to 6000m (0 to 20 000ft)	Reduce output power or ambient temperature above 2000m sea level.
Altitude de-rating	1W/1000m or 5°C/1000m	above 2000m (6500ft), see Fig. 14-2
Over-voltage category	III II	IEC 62103, EN 50178, altitudes up to 2000m Altitudes from 2000m to 6000m
Degree of pollution	2	IEC 62103, EN 50178, not conductive

*) Operational temperature is the same as the ambient temperature and is defined as the air temperature 2cm below the unit.

***) Do not energize while condensation is present

Fig. 14-1 Output current vs. ambient temp.

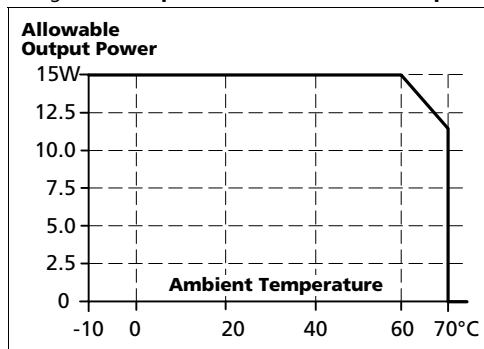
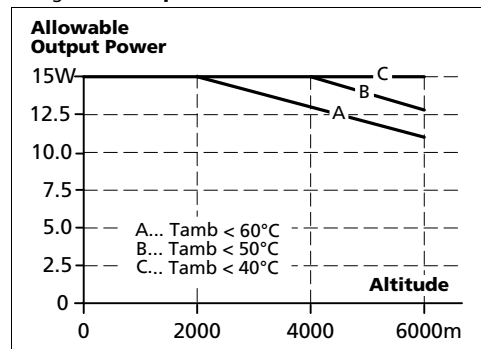

Fig. 14-2 Output current vs. altitude at 24V



15. PROTECTION FEATURES

Output protection	Electronically protected against overload, no-load and short-circuits *)	
Output over-voltage protection	typ. 8.7Vdc max. 9.6Vdc	In case of an internal power supply fault, a redundant circuit limits the maximum output voltage. In such a case, the output shuts down and stays down until the input voltage is turned off and on again.
Output over-current protection	electronically limited	see Fig. 6-2
Degree of protection	IP 20	EN/IEC 60529
Penetration protection	> 2.5mm in diameter	e.g. screws, small parts
Over-temperature protection	Not included	
Input transient protection	MOV	Metal Oxide Varistor
Internal input fuse	T3.15A H.B.C.	not user replaceable

*) In case of a protection event, audible noise may occur.

16. SAFETY FEATURES

Input / output separation *)	SELV PELV	IEC/EN 60950-1 IEC/EN 60204-1, EN 50178, IEC 62103, IEC 60364-4-41
Class of protection	I II (with restrictions)	PE (Protective Earth) connection required for use without PE connection contact PULS
Isolation resistance	> 5MΩ	Input to output, 500Vdc
Touch current (leakage current)	typ. 0.17mA typ. 0.25mA typ. 0.39mA < 0.21mA < 0.30mA < 0.55mA	100Vac, 50Hz, TN mains 120Vac, 60Hz, TN mains 230Vac, 50Hz, TN mains 110Vac, 50Hz, TN mains 132Vac, 60Hz, TN mains 264Vac, 50Hz, TN mains

*) Double or reinforced insulation

17. DIELECTRIC STRENGTH

The output voltage is floating and has no ohmic connection to the ground. Type and factory tests are conducted by the manufacturer. Field tests may be conducted in the field using the appropriate test equipment which applies the voltage with a slow ramp (2s up and 2s down). Connect all phase-terminals together as well as all output poles before conducting the test. When testing, set the cut-off current settings to the value in the table below.

Fig. 17-1 Dielectric strength

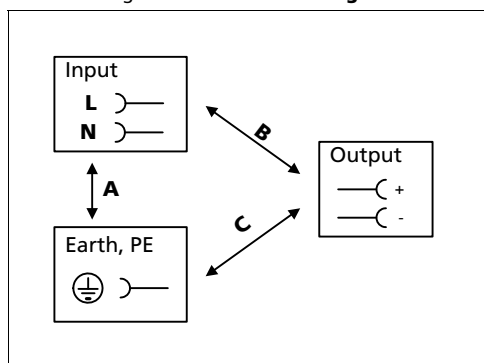

		A	B	C
Type test	60s	2500Vac	3000Vac	500Vac
Factory test	5s	2500Vac	2500Vac	500Vac
Field test	5s	2000Vac	2000Vac	500Vac
Cut-off current setting		> 6mA	> 6mA	> 1mA

To fulfill the PELV requirements according to EN60204-1 § 6.4.1, we recommend that either the + pole, the - pole or any other part of the output circuit shall be connected to the protective earth system. This helps to avoid situations in which a load starts unexpectedly or can not be switched off when unnoticed earth faults occur.

18. APPROVALS

IEC 60950-1		CB Scheme, Information Technology Equipment
UL 508		LISTED E-File: E198865 Industrial Control Equipment
UL 60950-1		RECOGNIZED for the use in U.S.A. (UL 60950-1) and Canada (C22.2 No. 60950-1) E-File: E137006 Information Technology Equipment, Level 3
NEC Class 2	NEC CLASS 2	According to NEC (National Electrical Code) Article 725-41 (4). Listed as Limited Power Source (LPS) in the UL 60950-1 UL report.
ANSI / ISA 12.12.01-2000		RECOGNIZED E246877 recognized for use in U.S.A. (ANSI / ISA 12.12.01-2000) and Canada (C22.2 No. 213-M1987) Hazardous Location Class I Div 2 T4 Groups A,B,C,D The unit is suitable for use in Class I Division 2 Groups A, B, C, D locations. Substitution of components may impair suitability for Class I Division 2 environment. Do not disconnect equipment unless power has been switched off. Wiring must be in accordance with Class I, Division 2 wiring methods of the National Electrical Code, NFPA 70, and in accordance with other local or national codes.
CSA 22.2 No107.1-01		CSA approval for Canada CAN/CSA C22.2 No 107-1; CAN/ CSA 60950-1-03; UL60950-1
Marine, pending		GL (Germanischer Lloyd) classified and ABS (American Bureau for Shipping) PDA Environmental category: C, EMC2 Marine and offshore applications

19. FULFILLED STANDARDS

EN 61558-2-17	Safety of Power Transformers
EN/IEC 60204-1	Safety of Electrical Equipment of Machines
EN/IEC 61131-2	Programmable Controllers
EN 50178, IEC 62103	Electronic Equipment in Power Installations

20. USED SUBSTANCES

The unit does not release any silicone and is suitable for the use in paint shops.

The unit conforms to the RoHS directive 2002/96/EC

Electrolytic capacitors included in this unit do not use electrolytes such as Quaternary Ammonium Salt Systems.

Plastic housings and other molded plastic materials are free of halogens, wires and cables are not PVC insulated.

The production material within our production does not include following toxic chemicals:

Polychlorized Biphenyl (PCB), Polychlorized Terphenyl (PCT), Pentachlorophenol (PCP), Polychlorinated naphthalene (PCN), Polybrom Biphenyl (PBB), Polybrom Biphenyl-oxyd (PBO), Polybrominated Diphenylether (PBDE), Polychlorinated Diphenylether (PCDE), Polydibromphenyl Oxid (PBDO), Cadmium, Asbest, Mercury, Silicia

21. PHYSICAL DIMENSIONS AND WEIGHT

Weight	130g / 0.29lb
DIN-Rail	Use 35mm DIN-rails according to EN 60715 or EN 50022 with a height of 7.5 or 15mm. The DIN-rail height must be added to the unit depth (91mm) to calculate the total required installation depth.
Installation Clearances	See chapter 2

Fig. 21-1 Front view

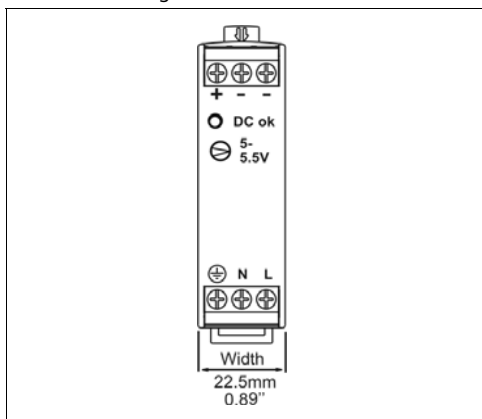
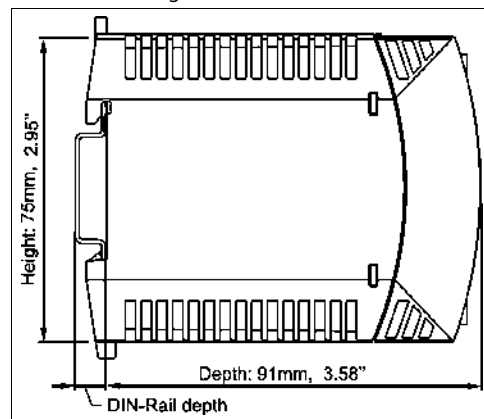

Fig. 21-2 Side view



22. APPLICATION NOTES

22.1. PEAK CURRENT CAPABILITY

Solenoids, contactors and pneumatic modules often have a steady state coil and a pick-up coil. The inrush current demand of the pick-up coil is several times higher than the steady-state current and usually exceeds the nominal output current (including the PowerBoost) The same situation applies, when starting a capacitive load.

Branch circuits are often protected with circuit breakers or fuses. In case of a short or an overload in the branch circuit, the fuse needs a certain amount of over-current to trip or to blow. The peak current capability ensures the safe operation of subsequent circuit breakers.

Assuming the input voltage is turned on before such an event, the built-in large sized output capacitors inside the power supply can deliver extra current. Discharging this capacitor causes a voltage dip on the output. The following two examples show typical voltage dips:

Fig. 22-1 **Peak loading with 2x the nominal current for 50ms, typ.**

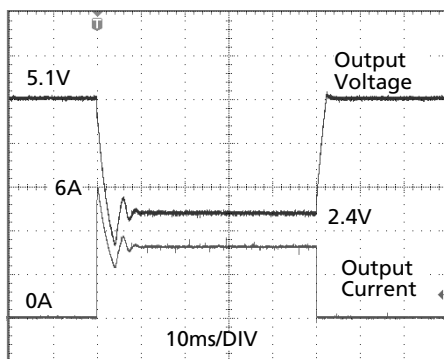

Peak load 6A (resistive load) for 50ms
Output voltage dips from 5.1V to 2.4V.

Fig. 22-2 **Peak loading with 5x the nominal current for 5ms, typ.**

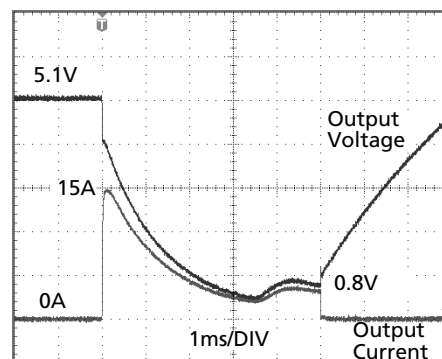

Peak load 15A (resistive load) for 5ms
Output voltage dips from 5.1V to 0.8V.

22.2. BACK-FEEDING LOADS

Loads such as decelerating motors and inductors can feed voltage back to the power supply. This feature is also called return voltage immunity or resistance against Back- E.M.F. (Electro Magnetic Force).

The maximum allowed feed back voltage is 6.3Vdc. The absorbing energy can be calculated according to the built-in large sized output capacitor which is specified in chapter 6.

This power supply is resistant and does not show malfunctioning when a load feeds back voltage to the power supply. It does not matter, whether the power supply is on or off. However, please note that the output voltage can dip to zero for approximately 200ms if the back-feed voltage is removed.

22.3. EXTERNAL INPUT PROTECTION

The unit is tested and approved for branch circuits up to 20A. An external protection is only required, if the supplying branch has an ampacity greater than this. Check also local codes and local requirements. In some countries local regulations might apply.

If an external fuse is necessary or utilized, minimum requirements need to be considered to avoid nuisance tripping of the circuit breaker. A minimum value of 10A B- or 6A C-Characteristic breaker should be used

22.4. PARALLEL USE TO INCREASE OUTPUT POWER

ML15.051 power supplies can be paralleled to increase the output power. This power supply has no feature included which balances the load current between the power supplies. Usually the power supply with the higher adjusted output voltage draws current until it goes into current limitation. This means no harm to this power supply as long as the ambient temperature stays below 45°C. The ML15.051 can also be paralleled with power supplies from MiniLine series with 5V output voltage. The output voltages of all power supplies shall be adjusted to the same value ($\pm 100\text{mV}$). A fuse or diode on the output of each unit is only required if more than three units are connected in parallel. If a fuse (or circuit breaker) is used, choose one with approximately 150% of the rated output current of one power supply. Keep an installation clearance of 15mm (left / right) between two power supplies and avoid installing the power supplies on top of each other. Do not use power supplies in parallel in mounting orientations other than the standard mounting orientation (input terminals on the bottom and output terminals on top of the unit). Pay attention that leakage current, EMI, inrush current, harmonics will increase when using multiple power supplies.

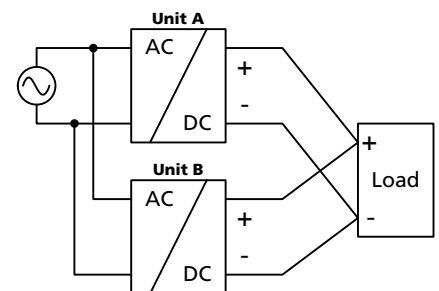

22.5. PARALLEL USE FOR REDUNDANCY

Power supplies can be paralleled for redundancy to gain higher system availability. Redundant systems require a certain amount of extra power to support the load in case one power supply unit fails. The simplest way is to put two power supplies in parallel. This is called a 1+1 redundancy. In case one power supply unit fails, the other one is automatically able to support the load current without any interruption. Redundant systems for a higher power demand are usually built in a N+1 method. E.g. five power supplies, each rated for 3A are paralleled to build a 12A redundant system.

Please note: This simple way to build a redundant system does not cover failures such as an internal short circuit in the secondary side of the power supply. In such a case, the defect unit becomes a load for the other power supplies and the output voltage can not be maintained any more. This can only be avoided by utilizing decoupling diodes which are included in the decoupling module MLY02.100.

Recommendations for building redundant power systems:

- Use separate input fuses for each power supply.
- Monitor the individual power supply units.
- 1+1 Redundancy is allowed up to an ambient temperature of 60°C
N+1 Redundancy is allowed up to an ambient temperature of 45°C
- It is desirable to set the output voltages of all units to the same value ($\pm 100\text{mV}$) or leave it at the factory setting.

22.6. SERIES OPERATION

Power supplies of the exact same type can be connected in series for higher output voltages. It is possible to connect as many units in series as needed, providing the sum of the output voltage does not exceed 150Vdc. Voltages with a potential above 60Vdc are not SELV any more and can be dangerous. Such voltages must be installed with a protection against touching. Earthing of the output is required when the sum of the output voltage is above 60Vdc. Avoid return voltage (e.g. from a decelerating motor or battery) which is applied to the output terminals. Keep an installation clearance of 15mm (left / right) between two power supplies and avoid installing the power supplies on top of each other. Do not use power supplies in series in mounting orientations other than the standard mounting orientation (input terminals on the bottom and output terminals on top of the unit). Pay attention that leakage current, EMI, inrush current, harmonics will increase when using multiple power supplies.

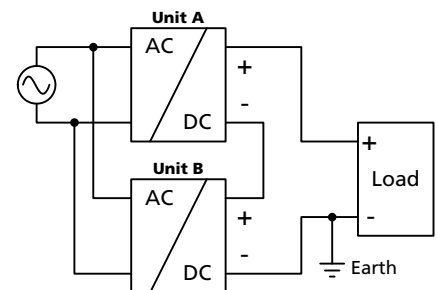

22.7. INDUCTIVE AND CAPACITIVE LOADS

The unit is designed to supply unlimited inductive loads.

The max. capacitive load depend on the steady state output current. At 3A output current, the output capacity should not be larger than 10 000 μF and at 0.3A output current not larger than 25 000 μF . In case of larger capacitors, the unit can show start-up attempts or start-up problems.

22.8. OPERATION ON TWO PHASES

The power supply can also be used on two-phases of a three-phase-system. Such a phase-to-phase connection is allowed as long as the supplying voltage is below $240V+10\%$. Use a fuse or a circuit breaker to protect the N input. The N input is internally not protected and is in this case connected to a hot wire. Appropriate fuses or circuit breakers are specified in section 22.3 "External Input Protection".

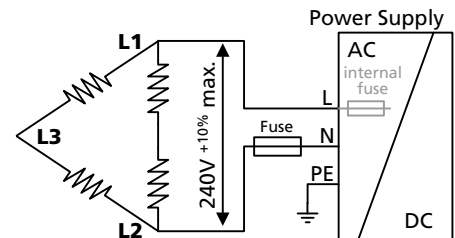

22.9. USE WITHOUT PE ON THE INPUT

From a safety standpoint, the unit is internally designed according to the requirements for Protection Class 1 and 2. Please contact PULS if you do not plan to use the PE terminal. A different marking of the front foil is then required. In such cases the PE terminal will change to an EMI ground terminal. Be aware that a connection to ground or earth of this terminal must be done in the same manner as it would be a "real" PE terminal. (wire size, isolation, ...)

Connecting this terminal can be beneficial to gain a high EMI immunity.

Symmetrical spikes or fast transients on the input side can be conducted directly to earth by the built-in filter capacitors. The magnitude of such spikes or fast transients on the output side caused by the input is much smaller compared to not connecting this terminal to ground.

Fig. 22-3 **Earthed input**

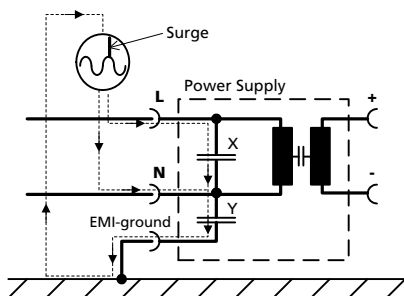
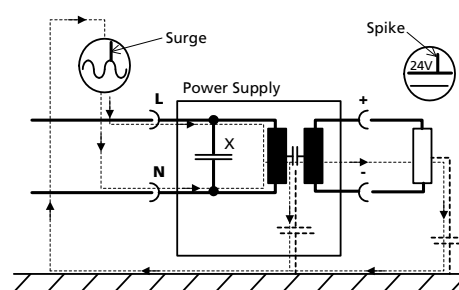

Fig. 22-4 **Not earthed input**



22.10. USE IN A TIGHTLY SEALED ENCLOSURE

When the power supply is installed in a tightly sealed enclosure, the temperature inside the enclosure will be higher than outside. In such situations, the inside temperature defines the ambient temperature for the power supply.

The following measurement results can be used as a reference to estimate the temperature rise inside the enclosure.

The power supply is placed in the middle of the box, no other heat producing items are inside the box

Enclosure: Rittal Type IP66 Box PK 9510 100, plastic, 130x130x75mm
Input: 230Vac

Case A:

Load: 5V, 3A; load is placed outside the box
Temperature inside the box: 38.2°C (in the middle of the right side of the power supply with a distance of 1cm)
Temperature outside the box: 26.0°C
Temperature rise: 12.2K

Case B:

Load: 5V, 2.4A; (=80%) load is placed outside the box
Temperature inside the box: 35.3°C (in the middle of the right side of the power supply with a distance of 1cm)
Temperature outside the box: 25.6°C
Temperature rise: 9.7K

22.11. MOUNTING ORIENTATIONS

Mounting orientations other than input terminals on the bottom and output on the top require a reduction in continuous output power or a limitation in the max. allowed ambient temperature. The amount of reduction influences the lifetime expectancy of the power supply. Therefore, two different derating curves for continuous operation can be found below:

Curve A1 Recommended output current.

Curve A2 Max allowed output current (results in approximately half the lifetime expectancy of A1).

Fig. 22-5
Mounting Orientation A
(Standard orientation)

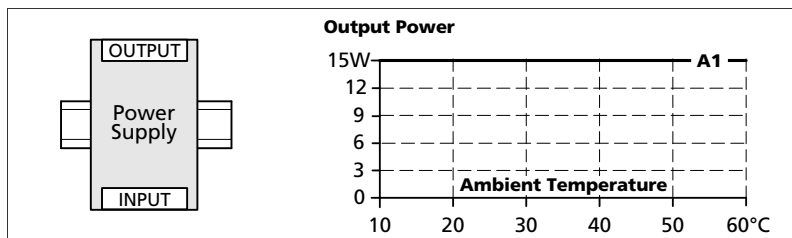

Fig. 22-6
Mounting Orientation B
(Upside down)

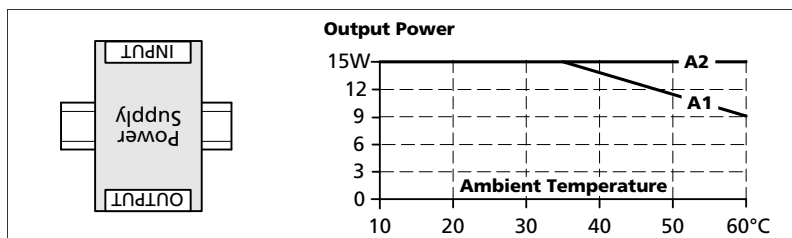

Fig. 22-7
Mounting Orientation C
(Table-top mounting)

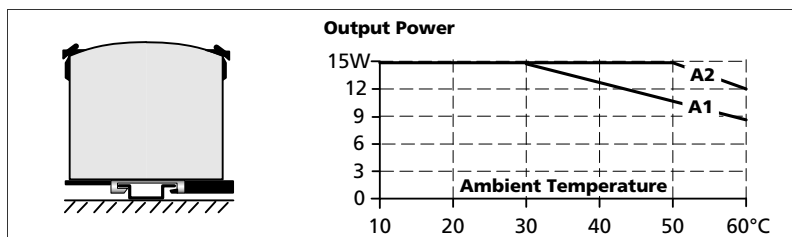

Fig. 22-8
Mounting Orientation D
(Horizontal cw)

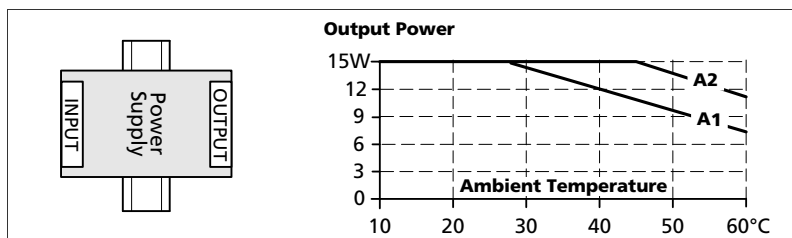

Fig. 22-9
Mounting Orientation E
(Horizontal ccw)

