



## Product information ELST 5012 PG7

Industrial Connecting Solutions: Circular Connectors: M8 - M12 Connectors: M12 Connectors: M12 Circular connector (M12 E-Series): with screw locking: Straight cable plug, self-assembled: ELST 5012 PG7

<https://e-catalog.hirschmann.com:443/link/57078-24228-256281-256292-256304-24445-24446-24271-36765/en/conf/ui/state>

Name	ELST 5012 PG7
	
	Straight cable plug, unassembled, strain relief by means of clamping cage
<b>Delivery informations</b>	
Availability	available
<b>Product description</b>	
Description	Straight cable plug, unassembled, strain relief by means of clamping cage
Type	ELST 5012 PG7
Order No.	933 163-100
Type of contact	male
Number of contacts	5
Cable gland	PG 7
Standard	IEC 61076-2-101 (Ed. 1)/ IEC 60947-5-2
Housing Color	black
<b>Technical data</b>	
Pin dimensions	1 mm
Rated voltage	AC/DC 50 V
Rated current	4 A
Type of termination	screw
Suitable cables	diameter 4 mm to 6 mm, max. 0.75 mm <sup>2</sup>
<b>Material</b>	
Contact material	Cu Zn
Contact surface material	Sn
Contact bearer material	PA
Housing material	PA
Coupling nut material	Zn Al/Ni
O-Ring	NBR
<b>Environmental conditions</b>	
Protection class (IEC 60529)	IP 67
Pollution severity	3
Temperature range	-25 °C to +90 °C
<b>Inflammability class</b>	
Housing	94 V-2
Contact bearer	94 V-2
<b>Packing unit</b>	
Packaging unit	100 pieces

Picture  
Drawing

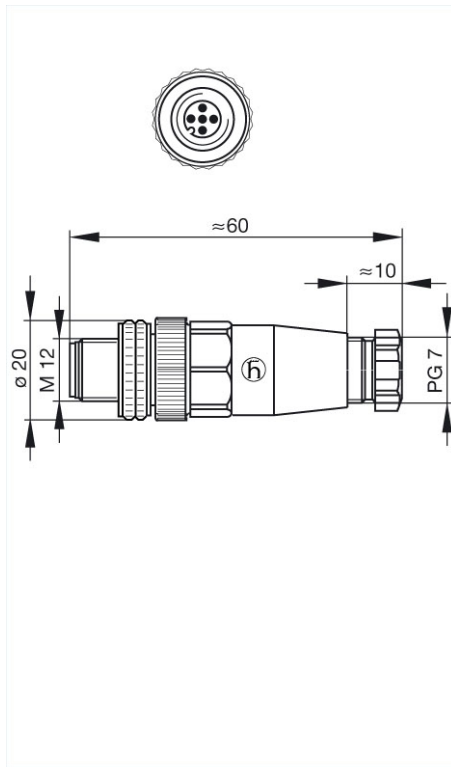

**Belden Deutschland GmbH**  
Im Gewerbepark 2  
58579 Schalksmühle  
Germany  
Phone: +49 7127/14-1806  
E-Mail: [icos-sales@belden.com](mailto:icos-sales@belden.com)

The information published in the websites has been compiled as carefully as possible. It is subject to alteration without notice in technical as well as in price-related/commercial respect. The complete information and data were available on user documentation. Mandatory information can only be obtained by a concrete query.