

## Data sheet | Item number: 221-510/000-006

Mounting carrier; 221 Series - 6 mm<sup>2</sup>; for DIN-35 rail mounting/screw mounting; blue

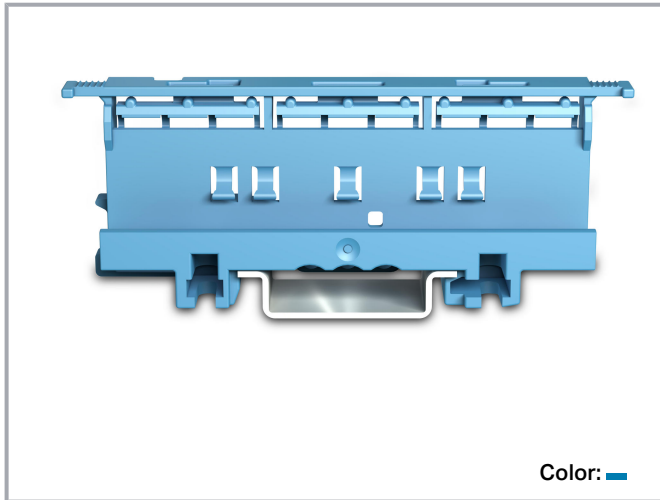

[www.wago.com/221-510/000-006](http://www.wago.com/221-510/000-006)



Color: 

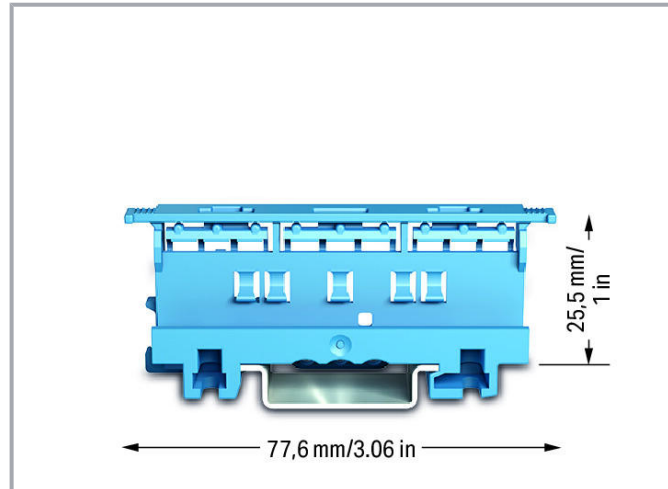

### Data

#### Physical data

Width	19.3 mm / 0.76 inch
Height	94.2 mm / 3.709 inch
Depth from upper edge of DIN-rail	28.3 mm / 1.114 inch

#### Mechanical data

Mounting type	DIN-35 rail Screw mount
Suitable	for 2-, 3- and 5-conductor 221 Series Splicing Connectors (6 mm <sup>2</sup> )

#### Material data

Color	blue
Insulation material	Polyamide (PA66)
Flammability class per UL94	V0
Weight	11.9 g

#### Commercial data

Packaging type	BOX
----------------	-----

Subject to changes. Please also observe the further product documentation!

WAGO Kontakttechnik GmbH & Co. KG  
Hansastr. 27  
32423 Minden  
Phone: +49571 887-0 | Fax: +49571 887-169  
Email: [info.de@wago.com](mailto:info.de@wago.com) | Web: [www.wago.com](http://www.wago.com)

Do you have any questions about our products?  
We are always happy to take your call at +49 (571) 887-44222.





Country of origin	CN
GTIN	4055143833554
Customs tariff number	39269097900

## Compatible products

### Marking accessories

	<b>Item no.: 210-833</b> Marking strips; on reel; 6 mm wide; plain; Self-adhesive; white	<a href="http://www.wago.com/210-833">www.wago.com/210-833</a>
---	---	--

### Mounting adapter

	<b>Item no.: 222-505</b> Strain relief plate; for mounting carrier; 221 or 222 Series, can be snapped	<a href="http://www.wago.com/222-505">www.wago.com/222-505</a>
	<b>Item no.: 222-510</b> Angled DIN-rail adapter; in combination with mounting carrier; 221-500 or 222-500; for DIN-35 rail mounting; gray	<a href="http://www.wago.com/222-510">www.wago.com/222-510</a>

## Downloads

### Documentation

#### Additional Information

Technical explanations	3 Apr 2019	pdf 2.2 MB	Download
------------------------	------------	---------------	----------

## CAD/CAE-Data

### CAD data

2D/3D Models 221-510/000-006	URL	Download
------------------------------	-----	----------

### CAE data

ZUKEN Portal 221-510/000-006	URL	Download
------------------------------	-----	----------

## Environmental Product Compliance

### Compliance Search

Environmental Product Compliance 221-510/000-006 Mounting carrier; 221 Series - 6 mm <sup>2</sup> ; for DIN-35 rail mounting/screw mounting; blue	URL	Download
--	-----	----------

Subject to changes. Please also observe the further product documentation!

## Installation Notes

### Conductor termination

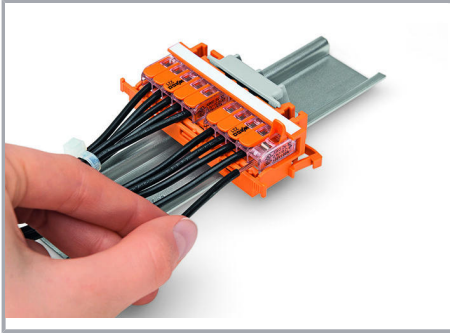

**CAGE CLAMP® connection:**

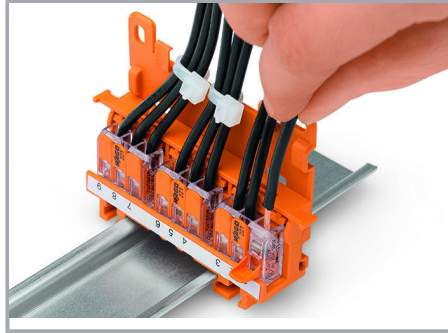

Removing a conductor.

### Conductor termination with connectors fitted in a mounting carrier

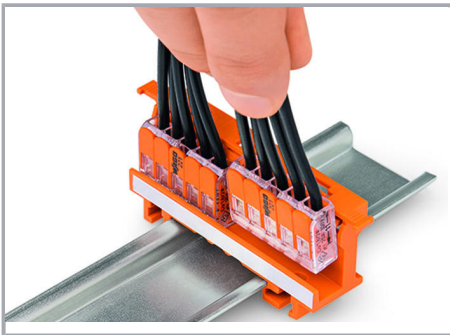

Inserting a connector into the mounting carrier.

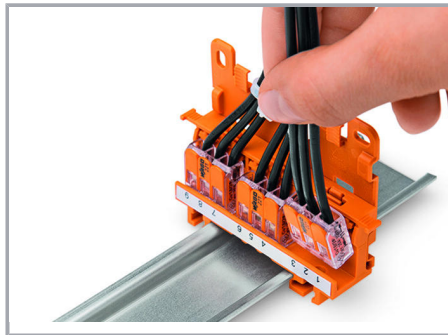

Inserting a connector into the mounting carrier.

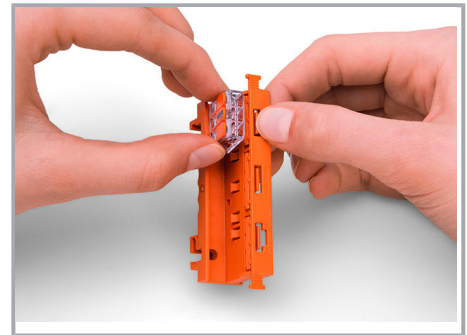

Removing a connector from the mounting carrier.

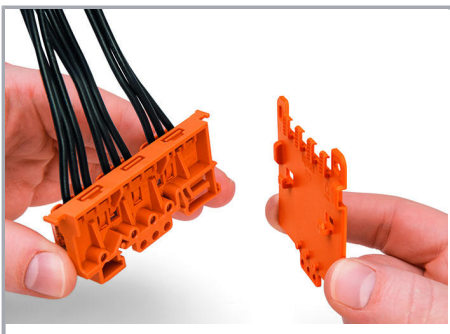

Securing a strain relief plate (222-505) to the mounting carrier.

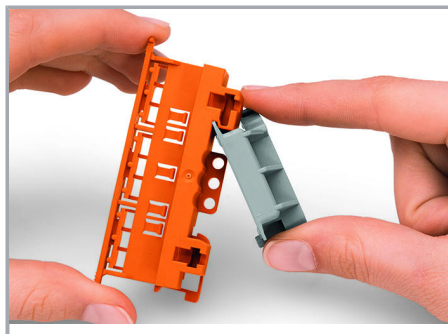

Snapping the angled DIN-rail adapter (222-510) onto the mounting carrier.

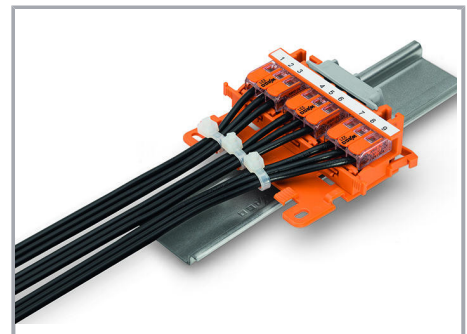

Horizontal mounting on DIN-35 rail using an angled DIN-rail adapter

Subject to changes. Please also observe the further product documentation!

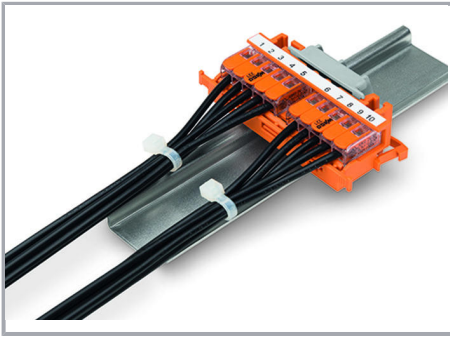

Horizontal mounting on DIN-35 rail using an angled DIN-rail adapter

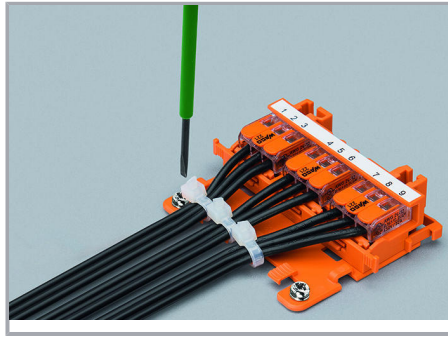

Horizontal screw mounting with strain relief plate on a flat surface

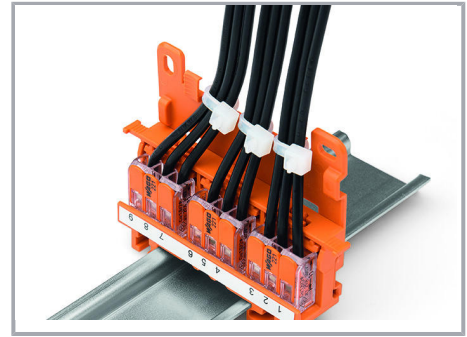

Vertical mounting with strain relief plate on DIN-35 rail

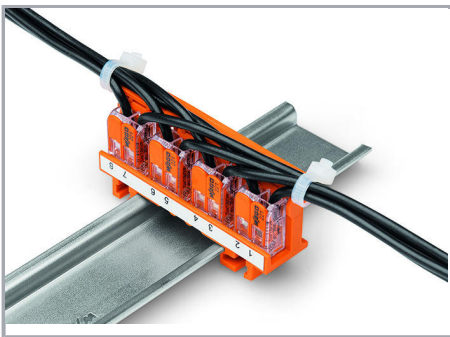

Strain relief via cable ties on the mounting carrier (transverse to the connectors' wiring direction) – clamping units labeled via marking strips (210-334)

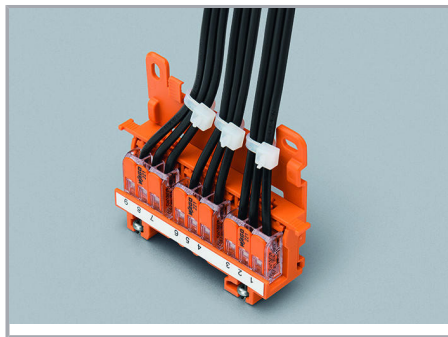

Vertical screw mounting with strain relief plate on a flat surface

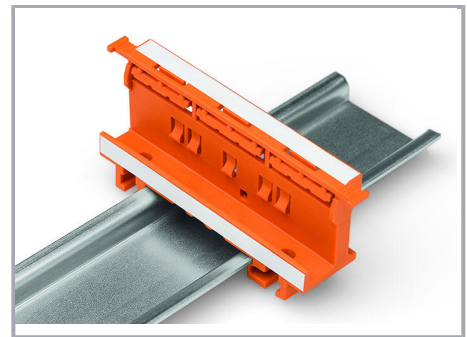

Mounting carrier on a DIN-35 rail

## Testing

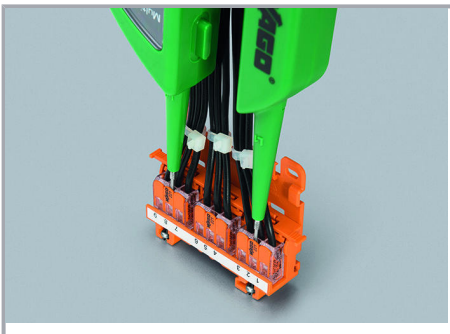

Testing connectors via test slots on top of the carrier.

Subject to changes. Please also observe the further product documentation!