

## Ball Lock Pins • single acting - comply with NASM / MS17984

4210.A06



### Product Description

Ball Lock Pins according to NASM 17984 (former norm: MS17984) are used for quick fastening, locking, adjusting, changing and securing. Quickly and easily unlockable for frequently repeated connections.

Ball Lock Pins (Quick Release Pins) are produced according to Aviation Norm NASM (former norm: MS) and tested to NAS 1332.

### Material

#### Pin ①

- Stainless steel, precipitation-hardened, passivated

#### Press bolt ②

- Stainless steel, precipitation-hardened, passivated

#### Spring ③

- Stainless steel, passivated

#### Handle ④

- Aluminium, black anodised

#### Attaching ring ⑤

- Stainless steel, passivated

#### Ball ⑥

- Stainless steel, precipitation-hardened, passivated

### Operation

The balls are unlocked by pressing the knob.

### More information

### Notes

All further dimensions are available on request.

Special types on request.

- This product is manufactured in INCH dimensions.

### References

A conversion table can be found in the technical data following these product information pages.

### Drawing

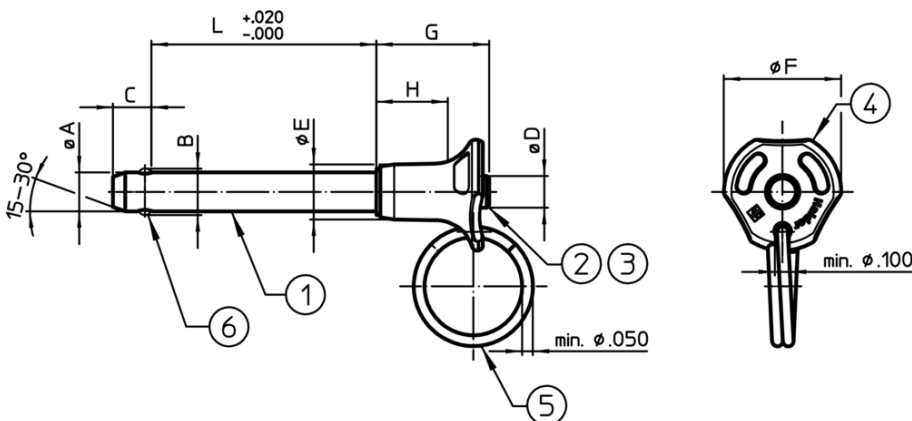

### Order information

Nominal diameter A	A min.	A max.	Clamping length L +0.02 0	Dimensions							Location hole max.	Shearing resistance, two-shear min.	Temperature		Weight [g]	Standard	Art. No.
				B ±0.005	C 0 -0.04	D max.	E max.	F max.	G max.	H min.			min.	max.			
[inch]	[inch]	[inch]	[inch]	[inch]							[inch]	[lb]	[°F]	[g]			
3/16	0.187	0.1885	0.6	0.22	0.26	0.31	0.44	0.8	0.83	0.48	0.194	5,150	-65	200	17	MS17984C306	4210.A06

## Compliance

### RoHS compliant

Compliant according to Directive 2011/65/EU and Directive 2015/863

### Does not contain SVHC substances

No SVHC substances with more than 0.1% w/w contained - SVHC list [REACH] as of 10.06.2022

### Does not contain Proposition 65 substances

No Proposition 65 substances included  
<https://www.P65Warnings.ca.gov/>

### Free from Conflict Minerals

This product does not contain any substances designated as "conflict minerals" such as tantalum, tin, gold or tungsten from the Democratic Republic of Congo or adjacent countries.