

E60007

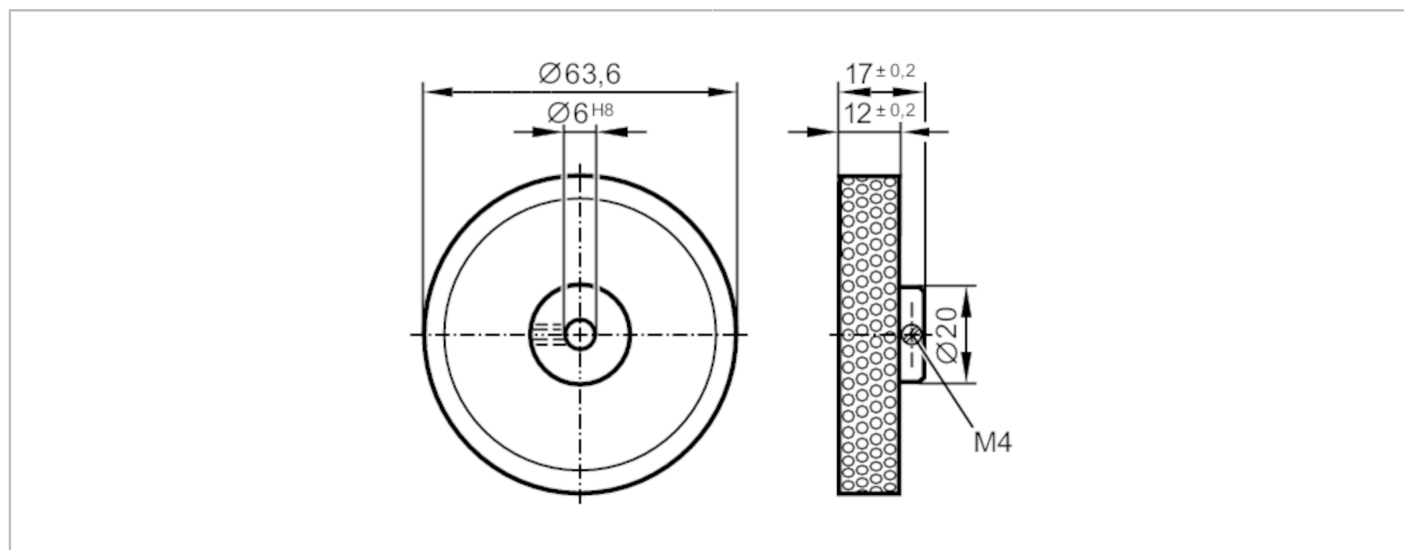

Measuring wheel

MEASURING WHEEL U:200 N:06



Application	
Design	rubber
Operating conditions	
Ambient temperature [°C]	-30...80
Mechanical data	
Weight [g]	38.1
Inside diameter [mm]	6
External diameter [mm]	63.6
Materials	wheel: aluminium; surface characteristics: PU
Surface hardness	60 Shore A
Circumference [mm]	200
Remarks	
Pack quantity	1 pcs.