

Product information

20 01 160

- Flat, short, wide jaws
- Knurled gripping surfaces
- Special tool steel, forged, oil-hardened

Flat Nose Pliers

DIN ISO 5745



General

Article No.	20 01 160
EAN	4003773033882
Pliers	black atramentized
Head	polished
Handles	plastic coated
Weight	140 g
Dimensions	160 x 50 x 13 mm
Standard	DIN ISO 5745
REACH compliant	does not contain SVHC
RoHS compliant	not applicable

Technical details

Jaw thickness (joint) (T1)	9.5 mm
Jaw length (L3)	30.0 mm
Head width (W3)	17.0 mm

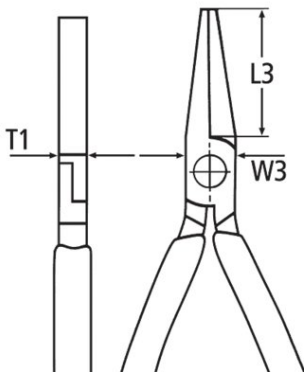

technical change and errors excepted

