



### FEATURES

- UL 60950 recognised
- Efficiency from 80%
- Wide temperature performance at full 2 watt load, -40°C to 85°C
- Industry standard pinout
- 1kVDC isolation 'Hi Pot Test'
- 5V, 12V, 15V & 24V inputs
- 5V, 9V, 12V & 15V outputs
- Internal SMD construction
- No external components required
- MTF up to 3.9 million hours
- Pin compatible with CMR, CRR1, NMR & MER1 series
- No electrolytic or tantalum capacitors

### PRODUCT OVERVIEW

The NMG series of DC-DC Converters is particularly suited to isolating and/or converting DC power rails. The galvanic isolation allows the device to be configured to provide an isolated negative rail in systems where only positive rails exist. The wide temperature range guarantees startup from -40°C and full 2 watt output at 85°C.

### SELECTION GUIDE

| Order Code  | Nominal Input Voltage | Output Voltage | Output Current | Input Current at Rated Load | Load Regulation (Typ) | Load Regulation (Max) | Ripple & Noise (Typ) <sup>1</sup> | Ripple & Noise (Max) <sup>1</sup> | Efficiency (Min.) | Efficiency (Typ.) | Isolation Capacitance | MTTF <sup>2</sup> | Recommended Alternative |
|---|-----------------------|----------------|----------------|-----------------------------|-----------------------|-----------------------|-----------------------------------|-----------------------------------|-------------------|-------------------|-----------------------|-------------------|-------------------------|
|   | V                     | V              | mA             | mA                          | %                     | %                     | mVp-p                             | mVp-p                             | %                 | %                 | pF                    | kHrs              |                         |
| <span style="border: 1px solid green; border-radius: 5px; padding: 2px;">Recommended</span> <span style="border: 1px solid blue; border-radius: 5px; padding: 2px; margin-left: 20px;">In Production</span> |                       |                |                |                             |                       |                       |                                   |                                   |                   |                   |                       |                   |                         |
| NMG0505SC   | 5                     | 5              | 400            | 470                         | 5.7                   | 7.3                   | 28                                | 35                                | 81                | 83                | 33                    | 3956              |                         |
| NMG0512SC   | 5                     | 12             | 167            | 450                         | 3.8                   | 5.1                   | 18                                | 25                                | 84                | 87.5              | 40                    | 3299              |                         |
| NMG0515SC   | 5                     | 15             | 133            | 450                         | 3.4                   | 4.5                   | 16                                | 25                                | 84                | 87.5              | 40                    | 2833              |                         |
| NMG0524SC   | 5                     | 24             | 83             | 465                         | 4.3                   | 6                     | 35                                | 60                                | 82                | 85                | 35                    | 2189              |                         |
| NMG1205SC   | 12                    | 5              | 400            | 200                         | 4.2                   | 4.9                   | 22                                | 35                                | 81                | 83.5              | 40                    | 2519              |                         |
| NMG1209SC   | 12                    | 9              | 222            | 190                         | 2.6                   | 3.1                   | 16                                | 25                                | 83                | 87                | 61                    | 2405              |                         |
| NMG1212SC   | 12                    | 12             | 167            | 190                         | 2.4                   | 2.9                   | 13                                | 25                                | 85                | 88                | 74                    | 2235              |                         |
| NMG1224SC   | 12                    | 24             | 83             | 190                         | 2.6                   | 4                     | 25                                | 40                                | 84                | 86.5              | 60                    | 2189              |                         |
| NMG1515SC   | 15                    | 15             | 133            | 150                         | 2.3                   | 3.5                   | 25                                | 40                                | 84                | 88                | 75                    | 2483              |                         |
| NMG2405SC   | 24                    | 5              | 400            | 100                         | 4.1                   | 6                     | 40                                | 70                                | 80                | 84                | 45                    | 3659              |                         |
| NMG2412SC   | 24                    | 12             | 167            | 95                          | 2.1                   | 3.5                   | 25                                | 50                                | 84                | 88                | 75                    | 3824              |                         |
| NMG2415SC   | 24                    | 15             | 133            | 95                          | 2                     | 3.5                   | 30                                | 50                                | 85                | 88.5              | 85                    | 3500              |                         |
| <span style="background-color: red; color: white; border-radius: 5px; padding: 2px;">To be discontinued</span>  |                       |                |                |                             |                       |                       |                                   |                                   |                   |                   |                       |                   |                         |
| NMG0509SC   | 5                     | 9              | 222            | 455                         | 4.2                   | 5.9                   | 20                                | 25                                | 84                | 86.5              | 40                    | 3682              | MEJ2S0509SC             |
| NMG1215SC   | 12                    | 15             | 133            | 185                         | 2.0                   | 2.4                   | 12                                | 25                                | 85                | 88                | 68                    | 2011              | MEJ2S1215SC             |
| NMG1505SC   | 15                    | 5              | 400            | 160                         | 4.3                   | 6                     | 40                                | 60                                | 80                | 83                | 40                    | 3963              | MEJ2S1505SC             |
| NMG2409SC   | 24                    | 9              | 222            | 95                          | 2.6                   | 4                     | 30                                | 50                                | 84                | 87.5              | 55                    | 2496              | NMK2409SAC              |
| <span style="background-color: black; color: white; border-radius: 5px; padding: 2px;">Discontinued</span>  |                       |                |                |                             |                       |                       |                                   |                                   |                   |                   |                       |                   |                         |
| NMG1509SC   | 15                    | 9              | 222            | 155                         | 2.9                   | 4.5                   | 25                                | 40                                | 82                | 86.5              | 55                    | 3176              | Contact Murata          |
| NMG1512SC   | 15                    | 12             | 167            | 150                         | 2.4                   | 3.5                   | 25                                | 40                                | 84                | 87.5              | 65                    | 2875              | Contact Murata          |

When operated **with** additional external load capacitance the rise time of the input voltage will determine the maximum external capacitance value for guaranteed start up. The slower the rise time of the input voltage the greater the maximum value of the additional external capacitance for reliable start up.

### INPUT CHARACTERISTICS

| Parameter                | Conditions                            | Min. | Typ. | Max. | Units  |
|--------------------------|---------------------------------------|------|------|------|--------|
| Voltage range            | Continuous operation, 5V input types  | 4.5  | 5    | 5.5  | V      |
|                          | Continuous operation, 12V input types | 10.8 | 12   | 13.2 |        |
|                          | Continuous operation, 15V input types | 13.5 | 15   | 16.5 |        |
|                          | Continuous operation, 24V input types | 21.6 | 24   | 26.4 |        |
| Reflected ripple current |                                       |      | 7.5  | 15   | mA p-p |

### OUTPUT CHARACTERISTICS

| Parameter   | Conditions                     | Min. | Typ. | Max. | Units |
|-------------|--------------------------------|------|------|------|-------|
| Rated Power | T <sub>A</sub> = -40°C to 85°C |      |      | 2    | W     |



 For full details go to <https://www.murata.com/en-global/products/power/rohs>



1. See Ripple & Noise characterisation method.  
 2. Calculated using MIL-HDBK-217F FN2 with nominal input voltage at full load.  
 All specifications typical at T<sub>A</sub> = 25°C, nominal input voltage and rated output current unless otherwise specified.

### ISOLATION CHARACTERISTICS

| Parameter              | Conditions                | Min. | Typ. | Max. | Units |
|------------------------|---------------------------|------|------|------|-------|
| Isolation test voltage | Flash tested for 1 second | 1000 |      |      | VDC   |
| Resistance             | Viso= 1000VDC             | 10   |      |      | GΩ    |

### GENERAL CHARACTERISTICS

| Parameter           | Conditions       | Min. | Typ. | Max. | Units |
|---------------------|------------------|------|------|------|-------|
| Switching frequency | 24V output types |      | 70   |      | kHz   |
|                     | All other types  |      | 60   |      |       |

### TEMPERATURE CHARACTERISTICS

| Parameter                      | Conditions                         | Min. | Typ. | Max. | Units |
|--------------------------------|------------------------------------|------|------|------|-------|
| Specification                  | All output types                   | -40  |      | 85   | °C    |
| Storage                        |                                    | -50  |      | 125  |       |
| Case Temperature above ambient | 5V input types and 5V output types |      |      | 30   |       |
|                                | All other types                    |      |      | 25   |       |
| Cooling                        | Free air convection                |      |      |      |       |

### ABSOLUTE MAXIMUM RATINGS

|   |  |
|---|--|
| Lead temperature 1.5mm from case for 10 seconds | 260°C  |
| Wave Solder                                     | Wave Solder profile not to exceed the profile recommended in IEC 61760-1 Section 6.1.3. Please refer to <a href="#">application notes</a> for further information. |
| Input voltage $V_{IN}$ , NMG05 types            | 7V   |
| Input voltage $V_{IN}$ , NMG12 types            | 15V  |
| Input voltage $V_{IN}$ , NMG15 types            | 18V  |
| Input voltage $V_{IN}$ , NMG24 types            | 28V  |

**TECHNICAL NOTES**

**ISOLATION VOLTAGE**

'Hi Pot Test', 'Flash Tested', 'Withstand Voltage', 'Proof Voltage', 'Dielectric Withstand Voltage' & 'Isolation Test Voltage' are all terms that relate to the same thing, a test voltage, applied for a specified time, across a component designed to provide electrical isolation, to verify the integrity of that isolation.

Murata Power Solutions NMG series of DC-DC converters are all 100% production tested at their stated isolation voltage. This is 1kVDC for 1 minute.

A question commonly asked is, "What is the continuous voltage that can be applied across the part in normal operation?"

The NMG series has been recognised by Underwriters Laboratory for functional insulation. Both input and output should normally be maintained within SELV limits i.e. less than 42.4V peak, or 60VDC. The isolation test voltage represents a measure of immunity to transient voltages and the part should never be used as an element of a safety isolation system. The part could be expected to function correctly with several hundred volts offset applied continuously across the isolation barrier; but then the circuitry on both sides of the barrier must be regarded as operating at an unsafe voltage and further isolation/insulation systems must form a barrier between these circuits and any user-accessible circuitry according to safety standard requirements.

**REPEATED HIGH-VOLTAGE ISOLATION TESTING**

It is well known that repeated high-voltage isolation testing of a barrier component can actually degrade isolation capability, to a lesser or greater degree depending on materials, construction and environment. The NMG series has toroidal isolation transformers, with no additional insulation between primary and secondary windings of enamelled wire. While parts can be expected to withstand several times the stated test voltage, the isolation capability does depend on the wire insulation. Any material, including this enamel (typically polyurethane) is susceptible to eventual chemical degradation when subject to very high applied voltages thus implying that the number of tests should be strictly limited. We therefore strongly advise against repeated high voltage isolation testing, but if it is absolutely required, that the voltage be reduced by 20% from specified test voltage.

This consideration equally applies to agency recognised parts rated for better than functional isolation where the wire enamel insulation is always supplemented by a further insulation system of physical spacing or barriers.

**SAFETY APPROVAL**

The NMG series has been recognised by Underwriters Laboratory (UL) to UL 60950 for functional insulation in a maximum ambient temperature of 85°C and/or case temperature limit of 130°C. Case temperature measured on the face opposite the pins. File number E151252 applies.

The NMG Series of converters are not internally fused so to meet the requirements of UL 60950 an input line fuse should always be used. An anti-surge 2A should be used for NMG05xxSC models, and an anti-surge 0.75A should be used for NMG12xxSC models. All fuses should be UL approved and rated to at least the maximum allowable DC input voltage.

**RoHS COMPLIANCE INFORMATION**



This series is compatible with RoHS soldering systems with a peak wave solder temperature of 260°C for 10 seconds. Please refer to [application notes](#) for further information. The pin termination finish is Tin Plate, Hot Dipped over Matte Tin with Nickel Preplate. This series are backward compatible with Sn/Pb soldering systems. For further information, please visit [www.murata-ps.com/rohs](http://www.murata-ps.com/rohs)

**PART NUMBER STRUCTURE**

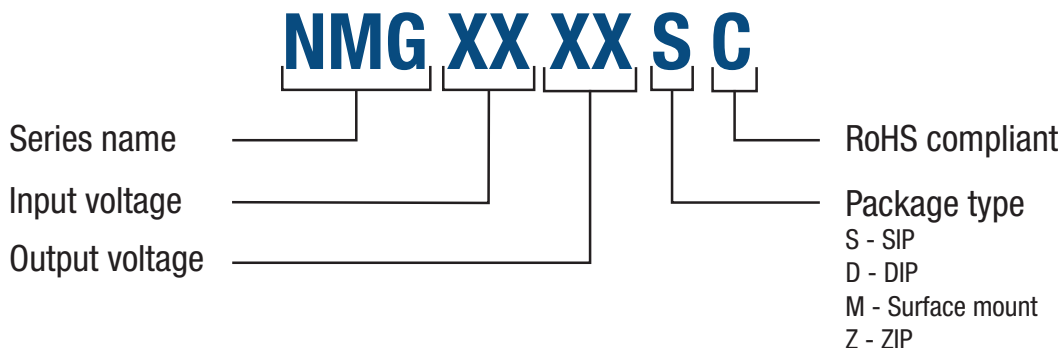

**CHARACTERISATION TEST METHODS**

**Ripple & Noise Characterisation Method**

All measurement to be taken with the following components connected to the UUT as detailed below. 50 Ohm coax cable, solder connections one end, BNC plug at the other end.

|       |  |
|-------|--|
| C1    | 1µF X7R multilayer ceramic capacitor, voltage rating to be a minimum of 3 times the output voltage of the DC-DC converter                        |
| C2    | 10µF tantalum capacitor rated at minimum 1.5 x the output voltage of the UUT with ESR of less than 100 milliohms at 100 kHz e.g. AVX TPS series. |
| C3    | 100nF multilayer ceramic capacitor, general purpose  |
| R1    | 450Ω resistor, carbon film, ±1% tolerance  |
| R2    | 50Ω BNC termination  |
| T1    | 3T of the coax cable through a ferrite toroid  |
| RLOAD | Resistive load to the maximum power rating of the DC-DC converter. Connections should be made via twisted wires                                  |

Measured values are multiplied by 10 to obtain the specified values.

**Differential Mode Noise Test Schematic**

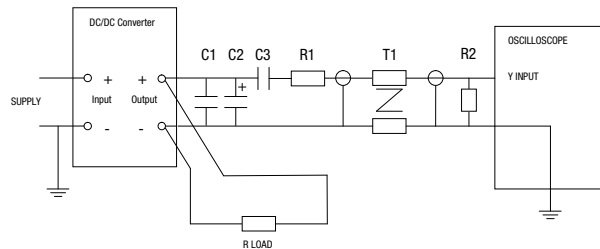

**APPLICATION NOTES**

**Minimum load**

The minimum load to meet datasheet specification is 10% of the full rated load across the specified input voltage range. Lower than 10% minimum loading will result in an increase in output voltage, which may rise to typically double the specified output voltage if the output load falls to less than 5%.

**Capacitive loading and start up**

Typical start up times for this series, with a typical input voltage rise time of 2.2µs and output capacitance of 10µF, are shown in the table below. The product series will start into a capacitance of 47µF with an increased start time, however, the maximum recommended output capacitance is 10µF.

|           | Start-up time<br>µs |           | Start-up time<br>µs |
|-----------|---------------------|-----------|---------------------|
| NMG0505SC | 444                 | NMG1505SC | 100                 |
| NMG0509SC | 1120                | NMG1509SC | 170                 |
| NMG0512SC | 1930                | NMG1512SC | 300                 |
| NMG0515SC | 3470                | NMG1515SC | 450                 |
| NMG1205SC | 409                 | NMG2405SC | 80                  |
| NMG1209SC | 1320                | NMG2409SC | 130                 |
| NMG1212SC | 1320                | NMG2412SC | 220                 |
| NMG1215SC | 2270                | NMG2415SC | 330                 |
| NMG0524SC | 2200                |           |                     |
| NMG1224SC | 1400                |           |                     |

**Typical Start-Up Wave Form**

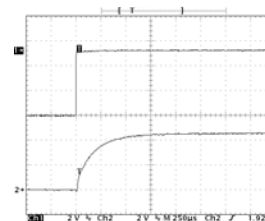

**APPLICATION NOTES (Continued)**

**Output Ripple Reduction**

By using the values of inductance and capacitance stated, the output ripple at the rated load is lowered to 5mV p-p max.

**Component selection**

**Capacitor:** It is required that the ESR (Equivalent Series Resistance) should be as low as possible, ceramic types are recommended.

The voltage rating should be at least twice (except for 15V output), the rated output voltage of the DC-DC converter.

**Inductor:** The rated current of the inductor should not be less than that of the output of the DC-DC converter. At the rated current, the DC resistance of the inductor should be such that the voltage drop across the inductor is <2% of the rated voltage of the DC-DC converter. The SRF (Self Resonant Frequency) should be >20MHz.

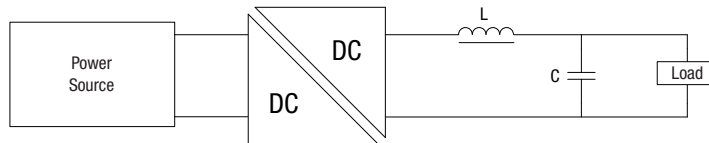

|           | Inductor   |        |              | Capacitor  |
|-----------|------------|--------|--------------|------------|
|           | L, $\mu$ H | SMD    | Through Hole | C, $\mu$ F |
| NMG0505SC | 4.7        | 82472C | 11R472C      | 10         |
| NMG0509SC | 10         | 82103C | 11R103C      | 4.7        |
| NMG0512SC | 22         | 82223C | 11R223C      | 2.2        |
| NMG0515SC | 47         | 82473C | 11R473C      | 1          |
| NMG0524SC | 47         | 82473C | 11R473C      | 1          |
| NMG1205SC | 4.7        | 82472C | 11R472C      | 10         |
| NMG1209SC | 10         | 82103C | 11R103C      | 4.7        |
| NMG1212SC | 22         | 82223C | 11R223C      | 2.2        |
| NMG1215SC | 47         | 82473C | 11R473C      | 1          |
| NMG1224SC | 47         | 82473C | 11R473C      | 1          |
| NMG1505SC | 4.7        | 82472C | 11R472C      | 10         |
| NMG1509SC | 10         | 82103C | 11R103C      | 4.7        |
| NMG1512SC | 22         | 82223C | 11R223C      | 2.2        |
| NMG1515SC | 47         | 82473C | 11R473C      | 1          |
| NMG2405SC | 4.7        | 82472C | 11R472C      | 10         |
| NMG2409SC | 10         | 82103C | 11R103C      | 4.7        |
| NMG2412SC | 22         | 82223C | 11R223C      | 2.2        |
| NMG2415SC | 47         | 82473C | 11R473C      | 1          |

**TOLERANCE ENVELOPES**

The voltage tolerance envelopes show typical load regulation characteristics for this product series. The tolerance envelope is the maximum output voltage variation due to changes in output loading and set point accuracy.

**1224, 1515, 2412, 2415**

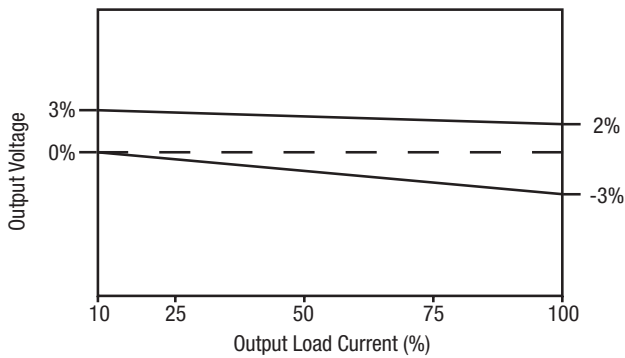

**2405**

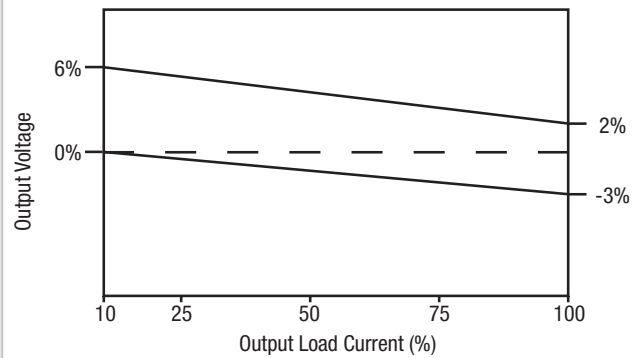

**05XX, 1205, 1209, 1212, 1215, 1505, 1509, 1512, 2409**

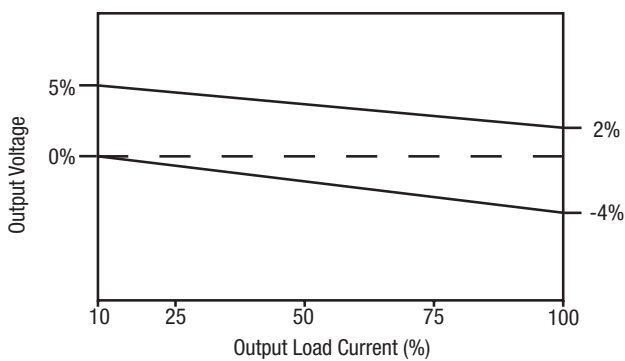

**TEMPERATURE DERATING GRAPH**

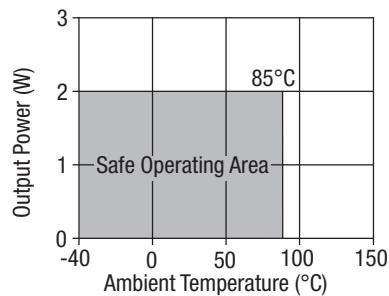

## EFFICIENCY VS LOAD

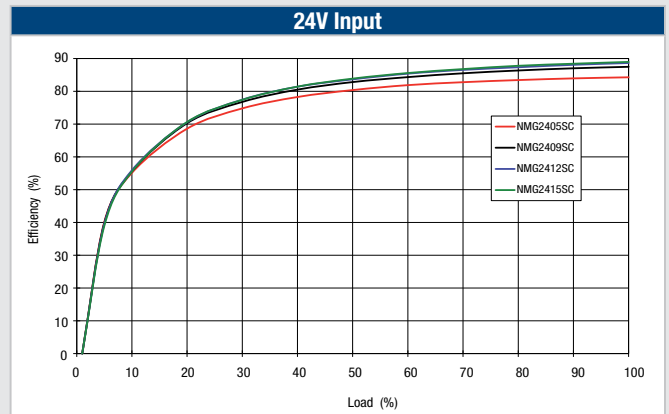
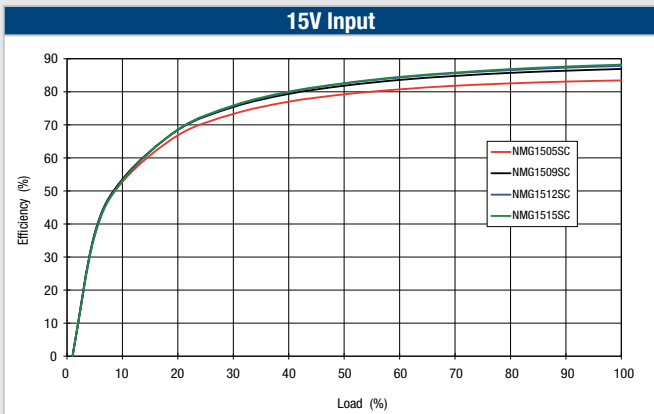
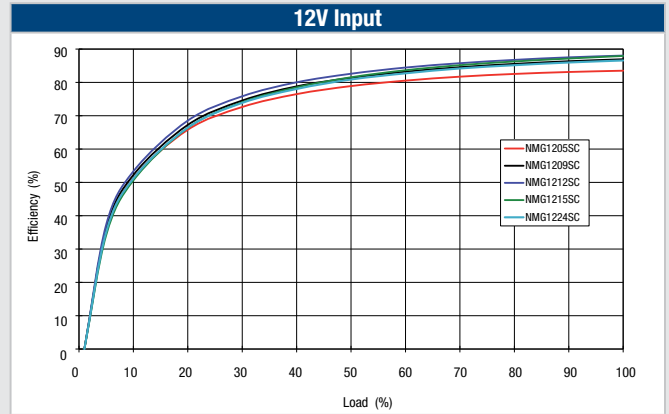
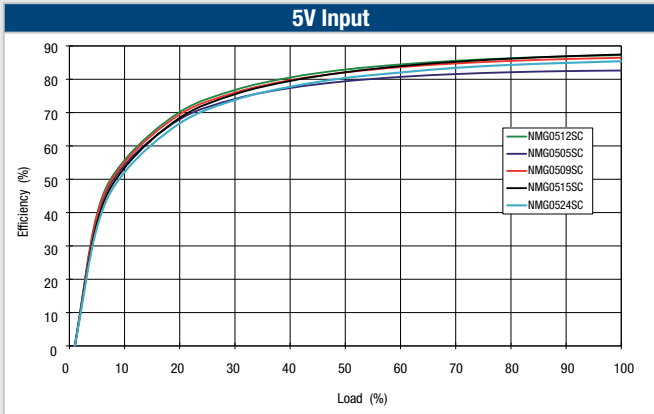

**PACKAGE SPECIFICATIONS**

**MECHANICAL DIMENSIONS**

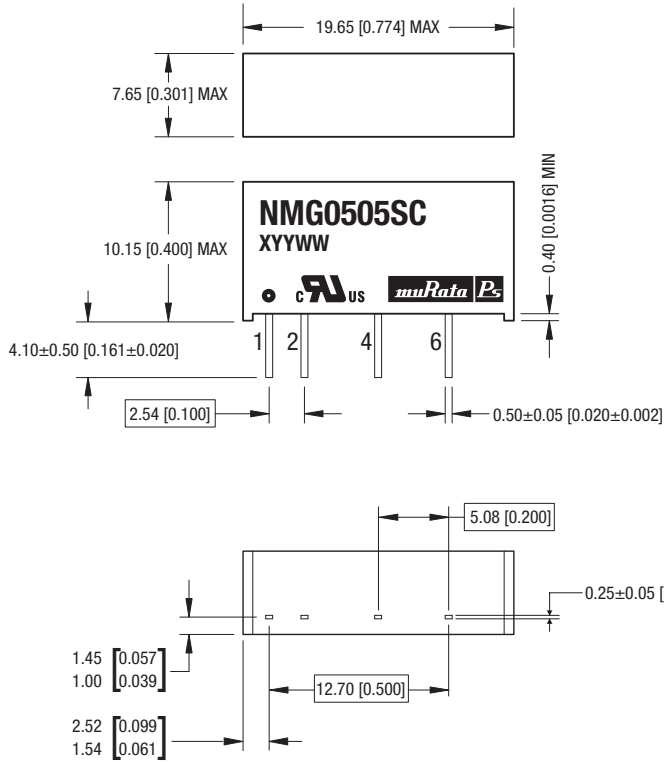

Unless otherwise stated all dimensions in mm (inches)  
 Controlling dimension is mm.  
 All pins on a 2.54mm (0.100") pitch and within 0.25mm (0.010") of true position.

Weight: 2.8g

**PIN CONNECTIONS - 4 PIN SIP**

| Pin | Function |
|-----|----------|
| 1   | +VIN     |
| 2   | -VIN     |
| 4   | -VOUT    |
| 6   | +VOUT    |

**TUBE OUTLINE DIMENSIONS**

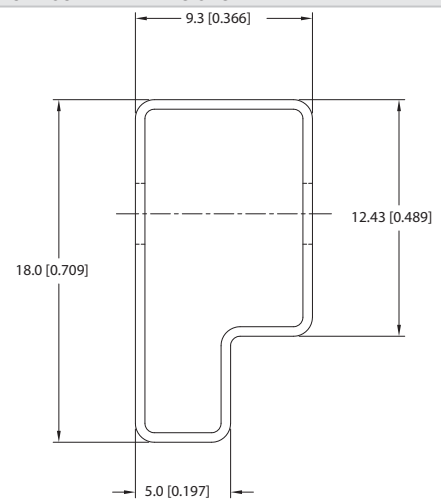

Unless otherwise specified all dimensions in mm (inches) ±0.55mm [0.022].  
 Tube Length : 520mm [20.472] ±2.0 [0.079].  
 Tube Quantity : 25

**RECOMMENDED FOOTPRINT DETAILS**

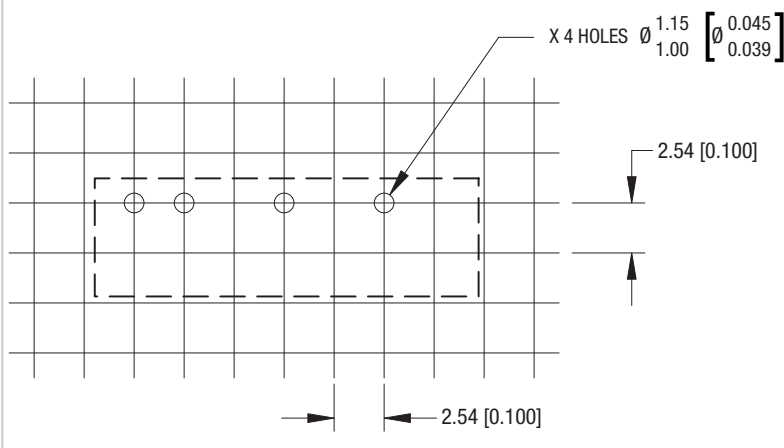



**DISCLAIMER**

Unless otherwise stated in the datasheet, all products are designed for standard commercial and industrial applications and NOT for safety-critical and/or life-critical applications.

Particularly for safety-critical and/or life-critical applications, i.e. applications that may directly endanger or cause the loss of life, inflict bodily harm and/or loss or severe damage to equipment/property, and severely harm the environment, a prior explicit written approval from Murata is strictly required. Any use of Murata standard products for any safety-critical, life-critical or any related applications without any prior explicit written approval from Murata shall be deemed unauthorised use.

These applications include but are not limited to:

- Aircraft equipment
- Aerospace equipment
- Undersea equipment
- Power plant control equipment
- Medical equipment
- Transportation equipment ( automobiles, trains, ships, etc.)
- Traffic signal equipment
- Disaster prevention / crime prevention equipment
- Data Processing equipment

Murata makes no express or implied warranty, representation, or guarantee of suitability, fitness for any particular use/purpose and/or compatibility with any application or device of the buyer, nor does Murata assume any liability whatsoever arising out of unauthorised use of any Murata product for the application of the buyer. The suitability, fitness for any particular use/purpose and/or compatibility of Murata product with any application or device of the buyer remain to be the responsibility and liability of the buyer.

Buyer represents and agrees that it has all the necessary expertise to create and implement safeguards that anticipate dangerous consequences of failures, monitor failures and their consequences, lessen the likelihood of failures that might cause harm, and take appropriate remedial actions. Buyer will fully indemnify and hold Murata, its affiliated companies, and its representatives harmless against any damages arising out of unauthorised use of any Murata products in any safety-critical and/or life-critical applications.

Remark: Murata in this section refers to Murata Manufacturing Company and its affiliated companies worldwide including, but not limited to, Murata Power Solutions.



This product is subject to the following [operating requirements](https://www.murata.com/en-eu/products/power/requirements) and the [Life and Safety Critical Application Sales Policy](https://www.murata.com/en-eu/products/power/requirements):

Refer to: <https://www.murata.com/en-eu/products/power/requirements>

Murata Power Solutions (Milton Keynes) Ltd. makes no representation that the use of its products in the circuits described herein, or the use of other technical information contained herein, will not infringe upon existing or future patent rights. The descriptions contained herein do not imply the granting of licenses to make, use, or sell equipment constructed in accordance therewith. Specifications are subject to change without notice.  
© 2022 Murata Power Solutions (Milton Keynes) Ltd.