

1 2 3 4 5 6

A

B

C

D

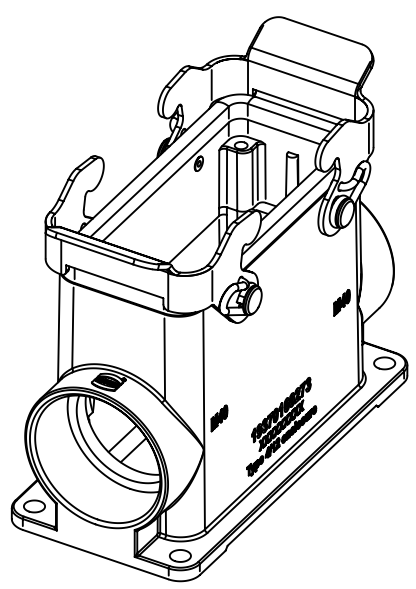
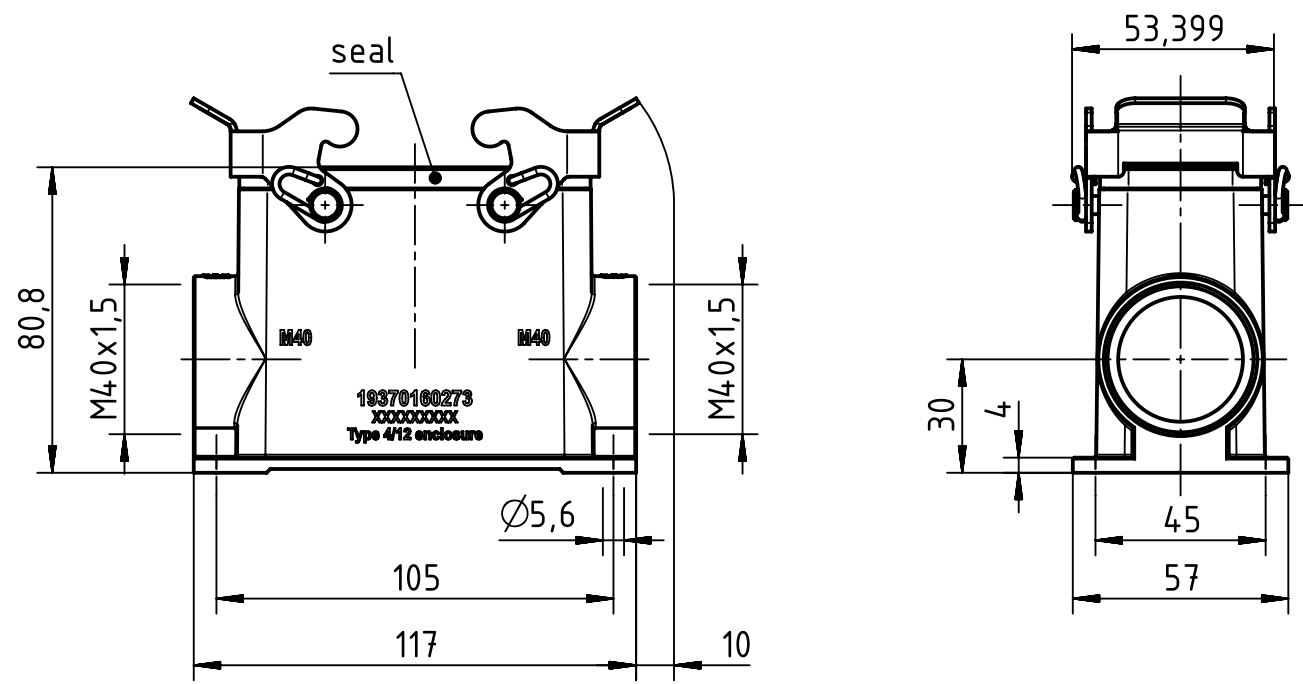

	All Dimensions in mm Original Size DIN A4		Scale 1:2	Free size tol.		Ref. Sub. TB 19 37 016 0273 v. 30.05.11	
		All rights reserved Department EL PD - DE	Created by RULLKOETTER	Inspected by BERGHORN	Standardisation TIEMANNA	Date 2016-08-01	State Final Release
HARTING Electric GmbH & Co. KG D-32339 Espelkamp		Title Han 16M-asg2-QB-M40			Doc-Key / ECM-Nr. 100212272/UGD/004/B 500000106755		
			Type TB	Number 19 37 016 0273		Rev. B	Page 1/1