









## Ficha técnica

### Rueda BH-PGI 1-0386

Codigo				Tipo cojinete Eje					
1-0386	80	60	22	—	70x55	54x38	6	110	77



#### Características

Fabricada con chapa de acero hasta 2 m/m de espesor.  
Soporte con doble rodamiento a bolas.  
Acabado cincado brillante.  
Fabricadas según normas europeas EN 12528/12530.

#### Datos técnicos

**Diámetro:** 80 mm  
**Carga:** 60 kg  
**Tipo de cojinete:** Cojinete Liso  
**Ancho de Banda de rodadura:** 22 mm  
**Medidas de placa superior:** 70x55 mm  
**Distancia entre agujeros:** 54x38 mm  
**Diámetro agujero sujeción platina:** 6 mm  
**Altura total:** 110 mm  
**Radio de giro:** 77 mm

#### Archivos CAD

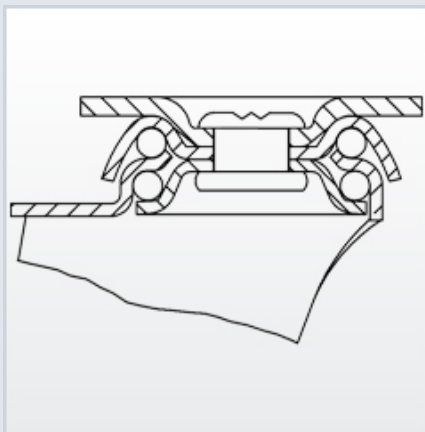

#### Rueda

**PGI (Goma)**  
Núcleo de poliamix y banda de goma gris  
**Rango de temperatura:** -20° ÷ +60°

#### Productos relacionados

