

Wire to Board Connectors

Features:

- 0.079" (2.00mm) contact spacing
- For use with PC board thickness: 0.047" (1.2mm) ~ 0.062" (1.6mm)
- Low profile insulator body, 0.185" (4.7mm) width 0.240" (6.10mm) Height
- Contact termination options include: P.C. tail, surface mount
- Top entry or side entry configurations
- Board retention contacts available
- Designed for high-density connection of internal wires to PCB

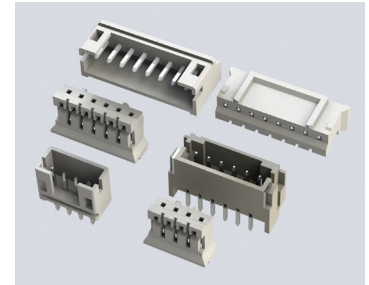

Specifications:

Insulator Material	PA66, UL94V-0, Natural Color	
Contact Material	Brass (For Male Header)	Phosphor Bronze (For Female Contact)
Contact Plating	Tin Plating (For Male Header)	Tin Plating, Copper Underplating (For Female Contact)
Current Rating	2 amps	
Voltage Rating	100 V	
Contact Resistance	Initial: 10 milliohms maximum	
Dielectric Withstanding Voltage	800 V AC rms	
Insulation Resistance	1000 megaohms minimum	
Operating Temperature	-40°C to +105°C	
Applicable Wire	AWG #30~#24	

Through-Hole Type Header:

TOP ENTRY

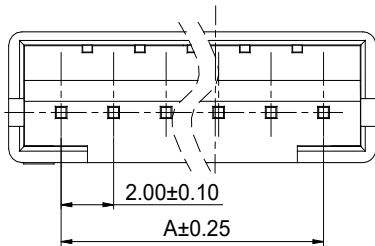

CAVITY NO.

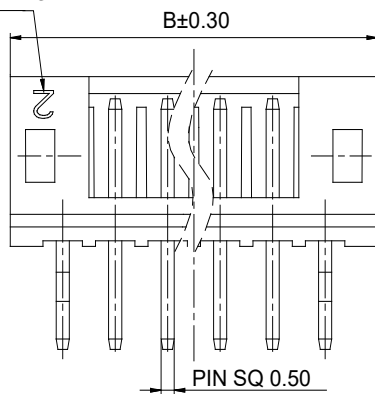

3P~16P

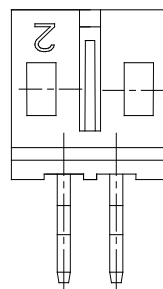

2P

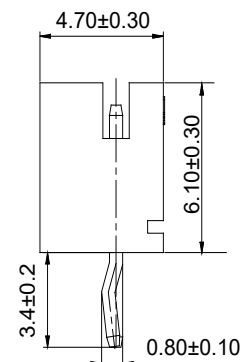

SIDE ENTRY

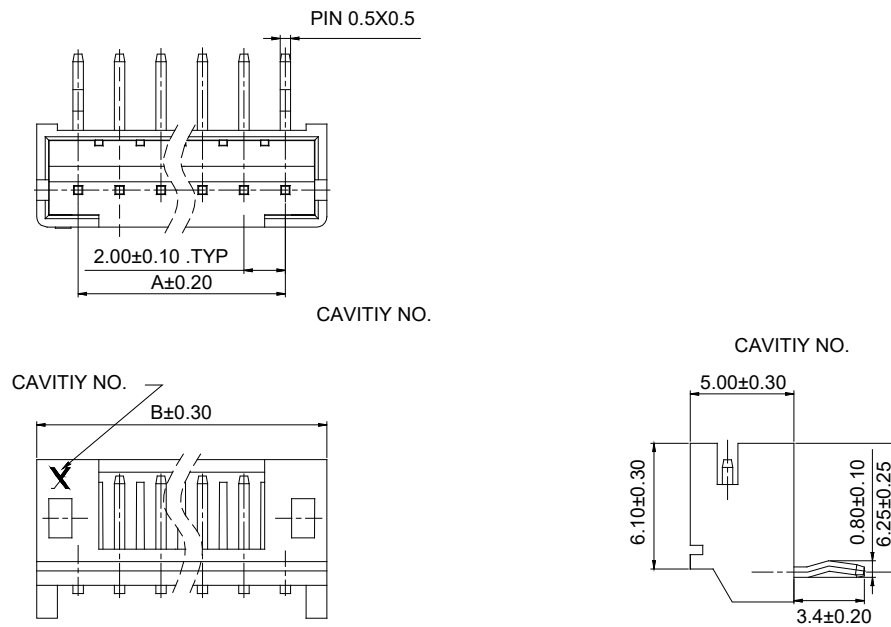

No.of Circuits	Top Entry	Side Entry		
	EDAC P/N	EDAC P/N	Dim A	Dim B
2	140-502-415-001	140-502-415-000	2.00	6.00
3	140-503-415-001	140-503-415-000	4.00	8.00
4	140-504-415-001	140-504-415-000	6.00	10.00
5	140-505-415-001	140-505-415-000	8.00	12.00
6	140-506-415-001	140-506-415-000	10.00	14.00
7	140-507-415-001	140-507-415-000	12.00	16.00
8	140-508-415-001	140-508-415-000	14.00	18.00
9	140-509-415-001	140-509-415-000	16.00	20.00
10	140-510-415-001	140-510-415-000	18.00	22.00
11	140-511-415-001	140-511-415-000	20.00	24.00
12	140-512-415-001	140-512-415-000	22.00	26.00

Through-Hole Header:

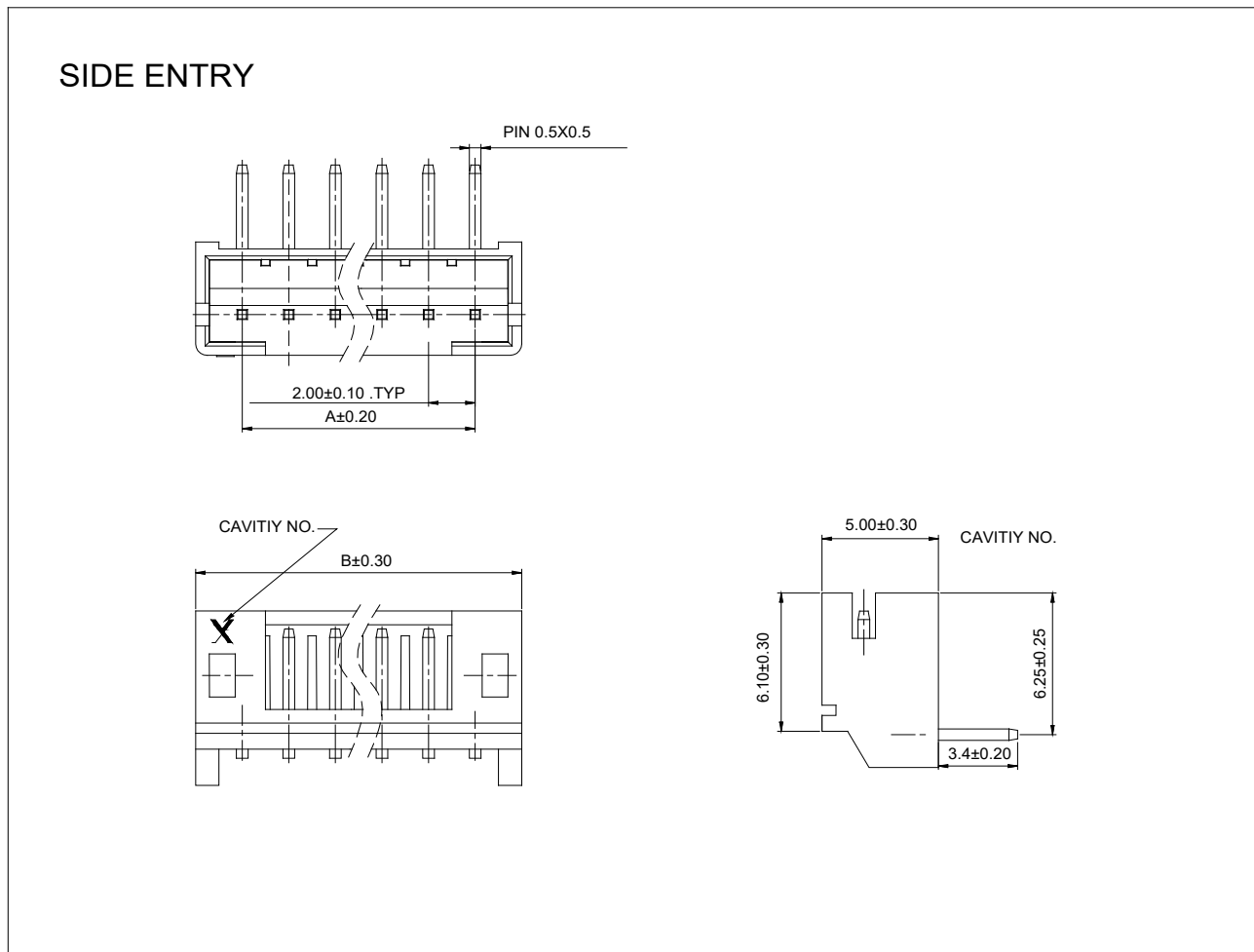
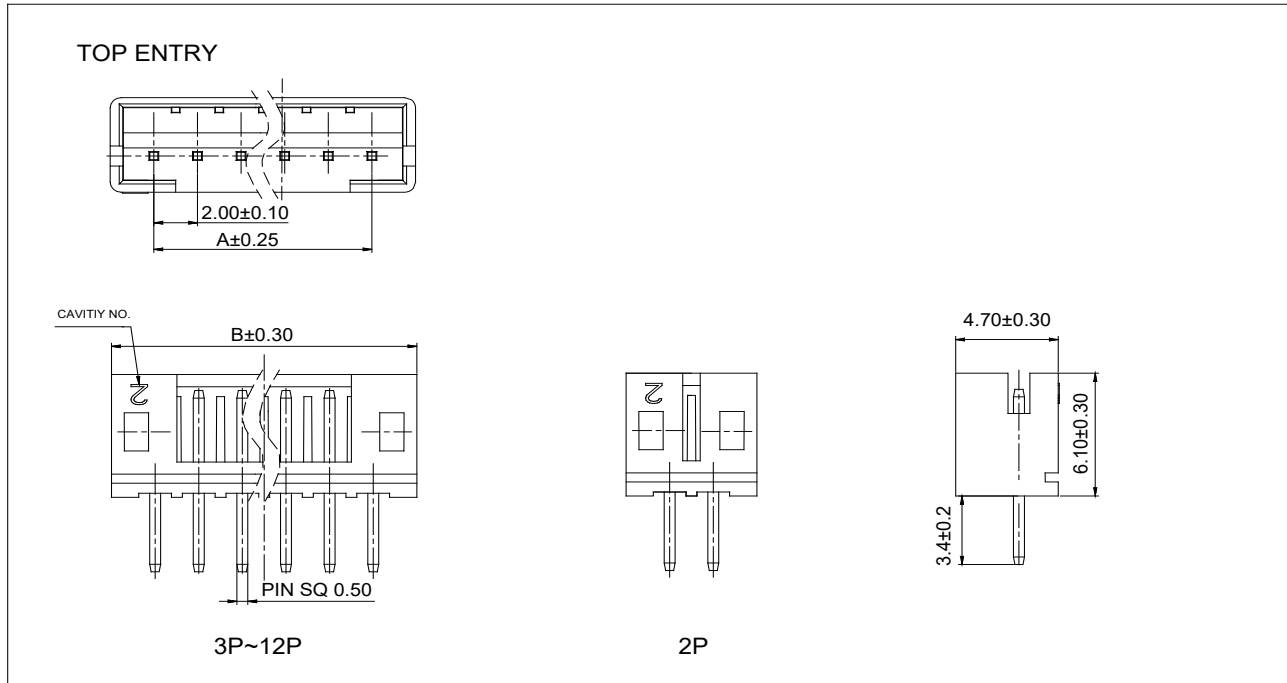

Through-Hole Header:

No. of Circuits	Top Entry	Side Entry		
	EDAC P/N	EDAC P/N	Dim A	Dim B
2	140-502-415-101	140-502-415-100	2.00	6.00
3	140-503-415-101	140-503-415-100	4.00	8.00
4	140-504-415-101	140-504-415-100	6.00	10.00
5	140-505-415-101	140-505-415-100	8.00	12.00
6	140-506-415-101	140-506-415-100	10.00	14.00
7	140-507-415-101	140-507-415-100	12.00	16.00
8	140-508-415-101	140-508-415-100	14.00	18.00
9	140-509-415-101	140-509-415-100	16.00	20.00
10	140-510-415-101	140-510-415-100	18.00	22.00
11	140-511-415-101	140-511-415-100	20.00	24.00
12	140-512-415-101	140-512-415-100	22.00	26.00

SMT Header:

TOP ENTRY

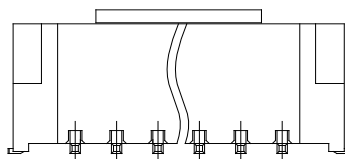
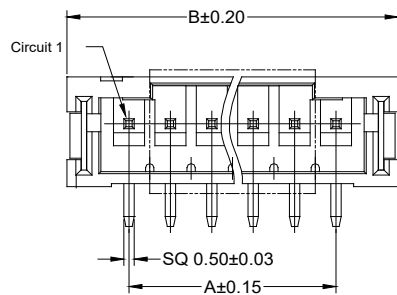

3P-16P

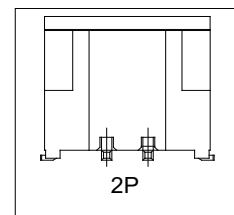

2P

SMT Header:

SIDE ENTRY

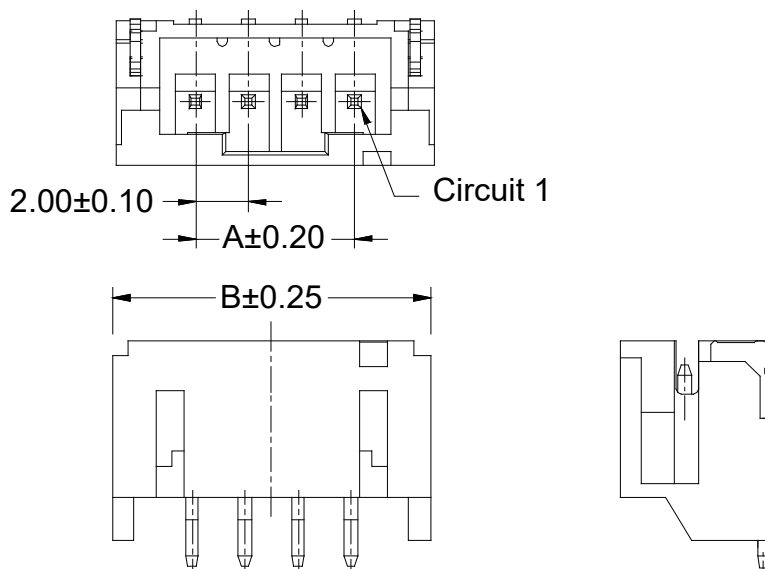

No. of Circuits	Top Entry	Side Entry		
	EDAC P/N	EDAC P/N	Dim A (mm)	Dim B (mm)
2	140-502-417-011	140-502-417-060	2.0	8.0
3	140-503-417-011	140-503-417-060	4.0	10.0
4	140-504-417-011	140-504-417-060	6.0	12.0
5	140-505-417-011	140-505-417-060	8.0	14.0
6	140-506-417-011	140-506-417-060	10.0	16.0
7	140-507-417-011	140-507-417-060	12.0	18.0
8	140-508-417-011	140-508-417-060	14.0	20.0
9	140-509-417-011	140-509-417-060	16.0	22.0
10	140-510-417-011	140-510-417-060	18.0	24.0
11	140-511-417-011	140-511-417-060	20.0	26.0
12	140-512-417-011	140-512-417-060	22.0	28.0
13	140-513-417-011	140-513-417-060	24.0	30.0
14	140-514-417-011	140-514-417-060	26.0	32.0
15	140-515-417-011	140-515-417-060	28.0	34.0
16	140-516-417-011	N/A	30.0	36.0

Wire to Board Connectors

Socket Housing:

	No. of Circuits	EDAC P/N	Dim A (mm)	Dim B (mm)
	2	140-502-210-011	2.00	5.80
	3	140-503-210-011	4.00	7.80
	4	140-504-210-011	6.00	9.80
	5	140-505-210-011	8.00	11.80
	6	140-506-210-011	10.00	13.80
	7	140-507-210-011	12.00	15.80
	8	140-508-210-011	14.00	17.80
	9	140-509-210-011	16.00	19.80
	10	140-510-210-011	18.00	21.80
	11	140-511-210-011	20.00	23.80
	12	140-512-210-011	22.00	25.80
	13	140-513-210-011	24.00	27.80
	14	140-514-210-011	26.00	29.80
	15	140-515-210-011	28.00	31.80
	16	140-516-210-011	30.00	33.80

Contact:

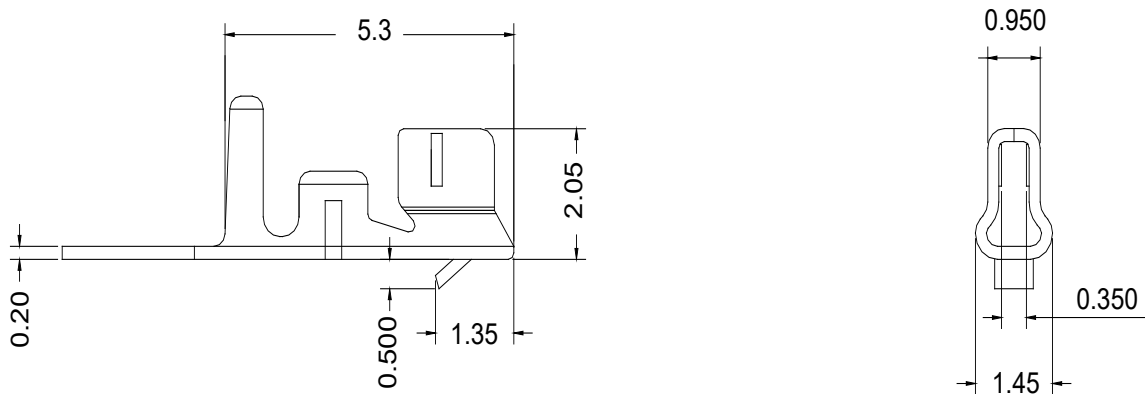

EDAC P/N	Wire Range	Insulation O.D	Material
140-941-290	24-30AWG	1.50 MAX.	Phosphor Bronze

PCB Layout:

Through hole top entry

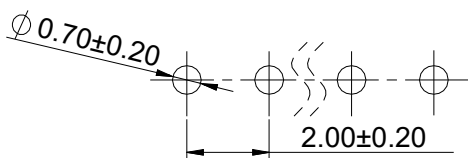

Recommended PCB Layout
 PCB Thickness: 1.20~1.60mm
 Tolerance: ± 0.05

Through hole side entry

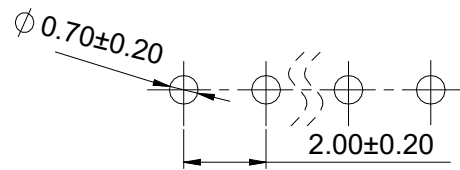

Recommended PCB Layout
 PCB Thickness: 1.20~1.60mm
 Tolerance: ± 0.05

SMT top entry

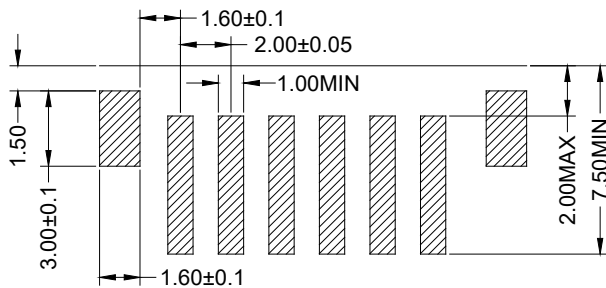

Recommended PCB Layout
 PCB Thickness: 1.20~1.60mm
 Tolerance: ± 0.05

SMT side entry

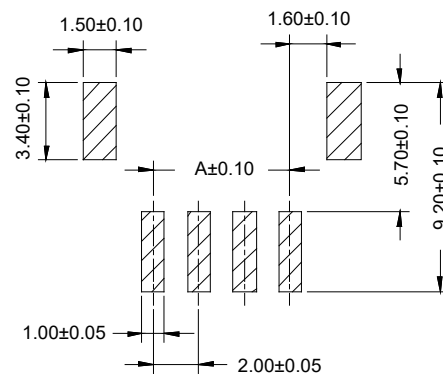

Recommended PCB Layout
 PCB Thickness: 1.20~1.60mm
 Tolerance: ± 0.05

TOLERANCE UNLESS OTHERWISE SPECIFIED	
.X	±0.25
.XX	±0.13
.XXX	±0.05

THIS IS A C.A.D. GENERATED DRAWING
DO NOT MAKE MANUAL REVISIONS TO MASTER.



ISSUE NUMBER	
ORIGINAL	①

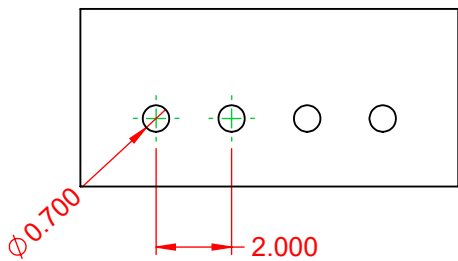
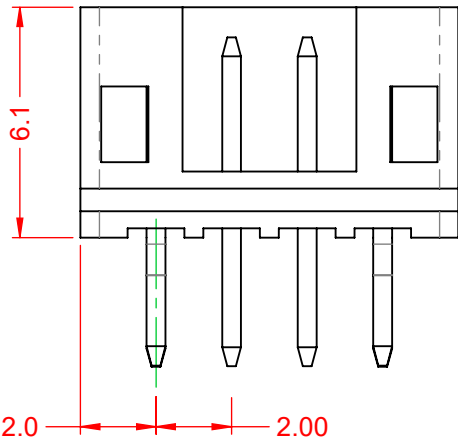
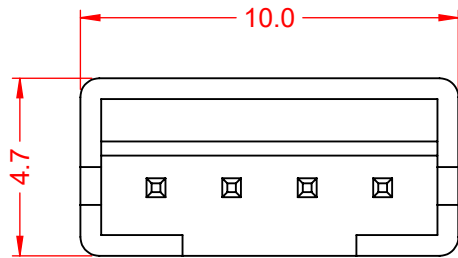

SUGGESTED PCB LAYOUT

- NOTES:
- CURRENT RATING: 2A AC/DC
 - VOLTAGE RATING: 100V AC/DC
 - TEMPERATURE RATING: -40°C ~ 105°C
 - CONTACT RESISTANCE: 10mΩ MAX.
 - HOUSING RESISTANCE: 1000MΩ min.
 - WITHSTANDING VOLTAGE: 800V AC / 60s
 - HOUSING MATERIAL: NYLON PA66, UL94V-0

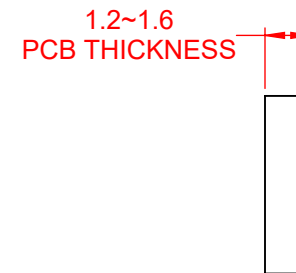
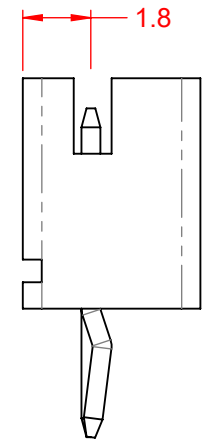

THIS SERIES FULLY CONFORMS TO
THE EUROPEAN UNION DIRECTIVES
2011/65/EU FOR RoHS COMPLIANCY.



YOUR CONNECTION TO QUALITY & SERVICE

EDAC INC
TORONTO, ONTARIO
CANADA

THESE DRAWINGS AND SPECIFICATIONS
ARE THE PROPERTY OF EDAC INC., AND
SHALL NOT BE REPRODUCED, OR COPIED
OR USED AS THE BASIS FOR THE
MANUFACTURE OR SALE OF APPARATUS
WITHOUT WRITTEN PERMISSION.

140 SERIES VERTICAL PCB MOUNT		ACAD REFERENCE NO.: 140 Assembly	
		DRAWN: C.B	DATE: March 27, 2020
CHECKED:	DATE:	SCALE: 5:1	SHEET 1 OF 1
DRAWING NUMBER: 140 Assembly	PART NUMBER: 140-504-415-001	ISSUE 1	