

en 02-2014/08 50110352

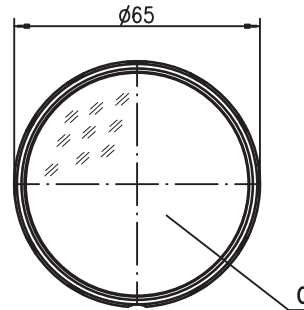

**Dimensioned drawing**

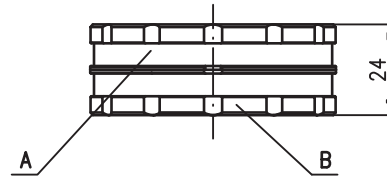

- **Increase of process reliability through optimised alignment**
- **Used to check the alignment quality**
- Mechanical-optical alignment aid
- Suitable for throughbeam photoelectric sensors and safety throughbeam photoelectric sensors
- Independent of light type (red light, infrared light, laser)
- Time-saving, as no mechanical adaption necessary
- Precise, through compensation of mechanical tolerances (housing, squint)

- A** Turnable 360°, capture range / deflection steplessly adjustable in mm/m
- B** Info on alignment direction
- C** Double prism

We reserve the right to make changes • DS\_AccessorySAT5\_en\_50110352.fm

## Technical data

### Optical data

Maximum deflection	60 mm/m
Minimum deflection	10 mm/m
Light type	suitable for red light, infrared light and laser

### Mechanical data

Housing	aluminium, anodised
Weight	100 g
Optics	plastic housing
Dimensions	Ø 65 mm x 24 mm

### Environmental data

Ambient temp. (operation/storage)	-30 °C ... +60 °C / -30 °C ... +70 °C
Protection class	IP 45

## Use

### A. Initial alignment

1. Align transmitter and receiver in x/y direction (horizontal/vertical).  
If the yellow LED illuminates on the receiver, then continue with **B**.
2. Set the Sensorscope SAT 5 to a deflection of 60 mm/m (red markings) and hold in front of the transmitter.
3. Turn the SAT 5 in front of the transmitter, thereby changing the deflection direction.  
While doing this, watch the yellow LED on the receiver.
4. As soon as the yellow LED flashes or illuminates continuously, ascertain the deflection direction (direction in which the coincident colour markings point).
5. Alignment:  
Align transmitter in the direction of the coincident colour markings (deflection direction).
6. Alignment optimisation:  
Set the SAT 5 to a deflection of 30 mm/m (green markings) and repeat steps 3 to 5.
7. Repeat the steps for the initial alignment on the receiver.

### B. Checking the alignment quality



8. Set the SAT 5 to a deflection of 10 mm/m (pink markings) and repeat steps 3 to 5.
9. While turning the Sensorscope 360°, the yellow LED on the receiver must illuminate constantly. The alignment of transmitter and receiver is now optimal.

## Remarks

### Intended use:

The Sensorscope is a mechanical-optical alignment aid for aligning transmitters and receivers of throughbeam photoelectric sensors.

#### Operate in accordance with intended use!

-  The product may only be put into operation by competent persons.
-  Only use the product in accordance with the intended use.

## Operating principle

Beam deflection with two opposing, turnable prisms.

### Maximum deflection 60 mm/m

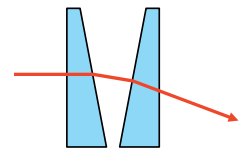
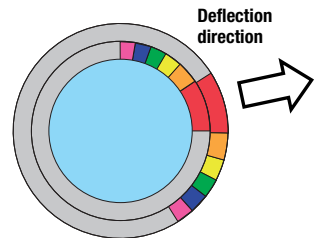

### Minimum deflection 10 mm/m

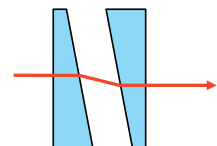
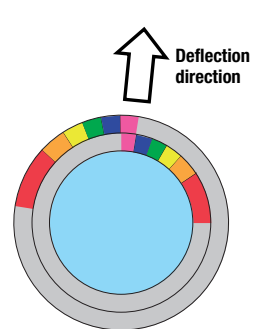

Deflection setting	
	— 60 mm/m
	— 50 mm/m
	— 40 mm/m
	— 30 mm/m
	— 20 mm/m
	— 10 mm/m

## Order guide

	Designation	Part No.
Sensorscope	SAT 5	50109545