

Digital Fiber Sensor FX-100 SERIES

Related Information

- General terms and conditions..... P.1
- Sensor selection guide.....P.11~ / P.61~
- Glossary of terms / General precautions...P.983~ / P.986~
- Fiber selection..... P.63~

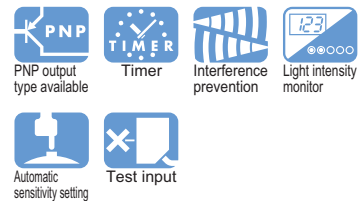

SUNX website <http://www.sunx.com>

Taking fiber sensors to the next level

Setup is made simple, using a dual digital display

The dual digital display allows users to check both the threshold value and incident light intensity at the same time, allowing for clear and intuitive control of the sensor's functions. The threshold value can be adjusted simply by pressing the Δ (UP) key or the ∇ (DOWN) key, so that the output operation can be controlled with high precision, directly from the RUN mode.

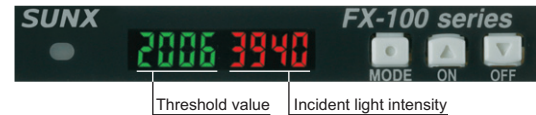

Commercially-available connectors are used so that lead time and spare part numbers can both be reduced

The connectors used are commercially-available connectors, so that processing costs and lead time required for carrying out processing after purchase of the sensors can be greatly reduced. The same connection parts as the DP-100 series of digital pressure sensors and the PM-64 series of micro photoelectric sensors can be used.

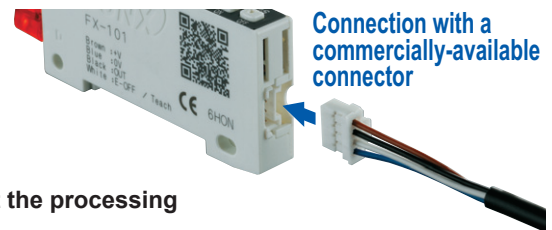

Commercially-available press-fit connectors are used, so that the processing costs for connection cables can be greatly reduced.

Conventional (cable type)

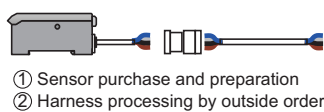

- ① Sensor purchase and preparation
- ② Harness processing by outside order

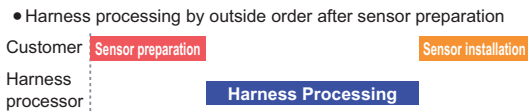

From now on (built-in connector type)

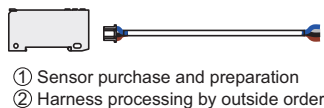

- ① Sensor purchase and preparation
- ② Harness processing by outside order

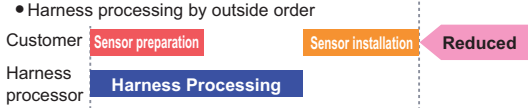

Using cables with connectors

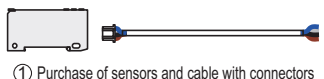

- ① Purchase of sensors and cable with connectors

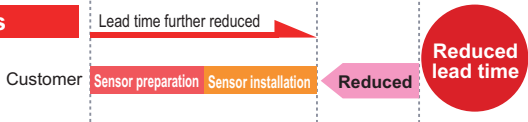

Saving-space with a width of 9 mm 0.354 in

The sensor is very slim, yet equipped with a dual digital display. Both space saving and ease of use have been achieved.



Equipped with a four-chemical emitting element

A stable amount of emitted light is ensured due to control of the aging of the emitting element to the maximum limit.

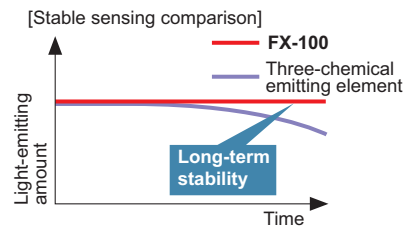

A three level navigation structure provides easy access to the sensor's functions, from basic to advanced

Setting details are divided into three levels for simple operation, so that settings for normal operation are made in "RUN mode", basic settings are made in "SET mode", and advanced functions are set in "PRO mode". This makes configuration much easier to understand and carry out.

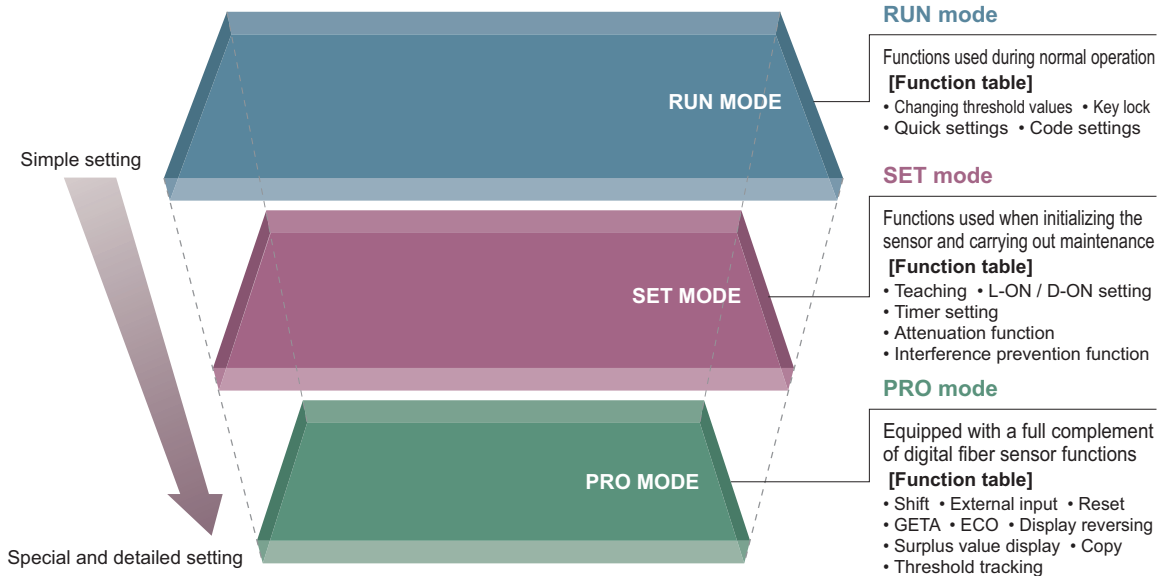

Quick code input function [RUN mode]

Sensor settings can be made simply by selecting preset values.



Quick setting numbers (summary)

No.	Output operation	Light-emitting amount selection	Timer
-00-	Dark-ON	OFF	None
-01-	Dark-ON	ON	None
-02-	Dark-ON	OFF	OFF-delay 10 ms
-03-	Dark-ON	ON	OFF-delay 10 ms
-10-	Light-ON	ON	ON-delay 40 ms
-11-	Light-ON	OFF	ON-delay 40 ms
-12-	Light-ON	ON	ON-delay 10 ms
-13-	Light-ON	OFF	ON-delay 10 ms

Smooth support via telephone [RUN mode]

Confirmation can be carried out smoothly via telephone by simply quoting numbers. This can be of great assistance when dealing with foreign country customers.



FIBER SENSORS

LASER SENSORS

PHOTOELECTRIC SENSORS

MICRO PHOTOELECTRIC SENSORS

AREA SENSORS

SAFETY COMPONENTS

PRESSURE SENSORS

INDUCTIVE PROXIMITY SENSORS

PARTICULAR USE SENSORS

SENSOR OPTIONS

WIRE-SAVING SYSTEMS

MEASUREMENT SENSORS

STATIC CONTROL DEVICES

LASER MARKERS

Selection Guide

Fibers

FT / FD / FR

Fiber sensor Amplifiers

FX-100

FX-300

FX-410

FX-311

FX-11A

FX-301-F

Other Products

FIBER SENSORS

LASER SENSORS

PHOTOELECTRIC SENSORS

MICRO PHOTOELECTRIC SENSORS

AREA SENSORS

SAFETY COMPONENTS

PRESSURE SENSORS

INDUCTIVE PROXIMITY SENSORS

PARTICULAR USE SENSORS

SENSOR OPTIONS

WIRE-SAVING SYSTEMS

MEASUREMENT SENSORS

STATIC CONTROL DEVICES

LASER MARKERS

Selection Guide

Fibers

FT / FD / FR

Fiber Sensor Amplifiers

FX-100

FX-300

FX-410

FX-311

FX-11A

FX-301-F

Other Products

Teaching using ON / OFF buttons [SET mode]

Simply press the ON button when an object is present and OFF when it is not. There is no need to switch settings or make judgments between Light-ON (L.ON) and Dark-ON (D.ON).

<Setting example>

Thru-beam type / Retroreflective type

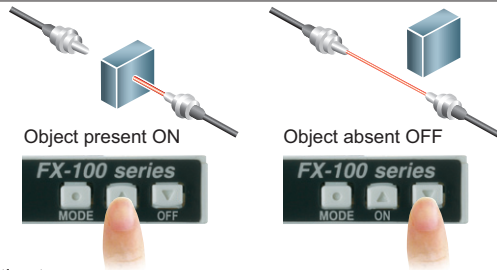

Reflective type

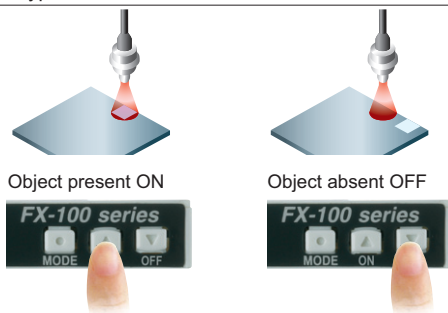

Limit teaching function

This carries out teaching and sets threshold values only when no object is present (when the incident light amount is stable). This is useful when sensing objects if there are other objects in the background and when sensing minute objects. Teaching can also be carried out using external input.

Threshold tracking function [PRO mode]

This function seeks changes in the light emitting amount resulting from changes in the environment over long periods (such as dust levels), so that the incident light intensity can be checked at desired intervals and the threshold values can be reset automatically.

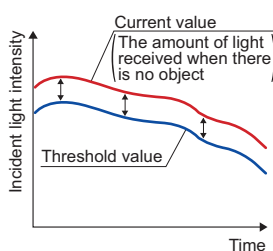

GETA function [PRO mode]

The display value for the incident light intensity can be offset by the desired value (target value). The target value can be set to between 0 and 2,000 (in increments of 100). For example, if the incident light intensity is 1,500 and the target value is set to 2,000, then "2,000" will appear in the digital display.

Variations in the amount of light received



Unify at 500 using the GETA function



Attenuation function [SET mode]

If the light receiving level becomes saturated when sensing over short distances or when sensing transparent objects or minute objects, the light emitting amount can be reduced so that stable sensing can be provided without needing to change the response time.

Interference prevention function [SET mode]

(FX-101□: Interference prevention for up to 3 units)
(FX-102□: Interference prevention for up to 4 units)

The emission frequencies can be set separately for each unit in order to avoid interference. The emitted light flashes while setting is in progress, so that you can see at a glance which fiber sensor is currently being set. In addition, this interference prevention is not done by using optical communication. This means that there is no need to place the amplifiers close together like there was before, and so the amplifiers can be set up apart from each other.

* When the emission frequencies are changed, the response times will also change.



The emitted light and output indicator flash at the same frequency.

Multi-function external input [PRO mode]

Settings such as emission halt, limit / auto teaching and ECO settings can be carried out via external input.

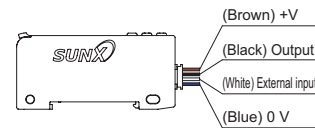

External input lines are equipped as standard

Alert function [PRO mode]

When the amount light received approaches the threshold value, the display can be made to blink in order to alert the operator.

<When using at a shift amount of 20% and a threshold value of 1,000>

The amount of light received ranges from about 900 to 1,100 when the digital indicator flashes.

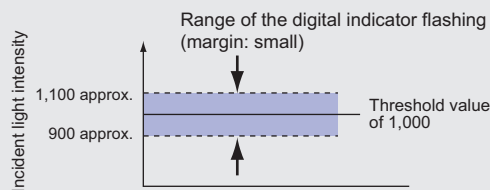

The digital indicator flashes.

ORDER GUIDE

Amplifiers

Type	Appearance	Model No.	Emitting element	Output
Standard type		FX-101 (Note 2)	Red LED	NPN open-collector transistor
		FX-101-Z (Note 3)		NPN open-collector transistor
		FX-101P (Note 2)		PNP open-collector transistor
		FX-101P-Z (Note 3)		PNP open-collector transistor
		Cable set (Note 1)		FX-101-CC2
Long sensing range type		FX-101P-CC2		PNP open-collector collector transistor
		FX-102 (Note 2)		NPN open-collector transistor
		FX-102-Z (Note 3)		NPN open-collector transistor
		FX-102P (Note 2)		PNP open-collector transistor
		FX-102P-Z (Note 3)		PNP open-collector transistor
		Cable set (Note 1)	FX-102-CC2	NPN open-collector transistor
			FX-102P-CC2	PNP open-collector transistor

Accessory

- **CN-14A-C2**
(Connector attached cable 2 m 6.562 ft)
* Only include cable set type



Notes: 1) The connector attached cable **CN-14A-C2** is supplied with the amplifier.
 2) Make sure to use the optional connector attached cable **CN-14A(-R)-C□** or the connector **CN-14A**, or a connector manufactured by J.S.T. Mfg. Co., Ltd. (contact: SPHD-001T-P0.5, housing: PAP-04V-S)
 3) Make sure to use the optional M8 connector attached cable **CN-24A-C□**.

OPTIONS

Designation	Model No.	Description
Connector attached cable	CN-14A-C1	1 m 3.281 ft
	CN-14A-C2 (Note)	2 m 6.562 ft
	CN-14A-C3	3 m 9.843 ft
	CN-14A-C5	5 m 16.404 ft
Connector attached cable (Flexible type)	CN-14A-R-C1	1 m 3.281 ft
	CN-14A-R-C2	2 m 6.562 ft
	CN-14A-R-C3	3 m 9.843 ft
	CN-14A-R-C5	5 m 16.404 ft
M8 connector attached cable	CN-24A-C2	2 m 6.562 ft
	CN-24A-C5	5 m 16.404 ft
Connector	CN-14A	Set of 10 housings and 40 contacts
Protection cover	FC-FX-1	This protects the operating surfaces.
Amplifier mounting bracket	MS-DIN-4	Mounting bracket for amplifier
End plates	MS-DIN-E	When it moves depending on the way it is installed on a DIN rail, these end plates ensure that all amplifiers are mounted together in a secure and fully connected manner. Two pcs.per set

Note: The connector attached cable **CN-14A-C2** is supplied with the cable set type **FX-10□(P)-CC2**.

Recommended connector

Contact: SPHD-001T-P0.5, Housing: PAP-04V-S (Manufactured by J.S.T. Mfg. Co., Ltd.)
 Note: Contact the manufacturer for details of the recommended products.

Recommended crimping tool

Model No.: YC-610R (Manufactured by J.S.T. Mfg. Co., Ltd.)
 Note: Contact the manufacturer for details of the recommended products.

Connector attached cable

- **CN-14A(-R)-C□**

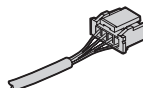

Connector

- **CN-14A**

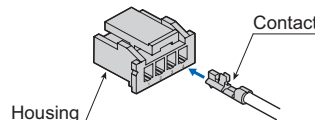

M8 connector attached cable

- **CN-24A-C□**

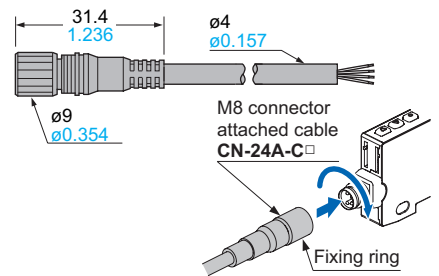

Protection cover

- **FC-FX-1**

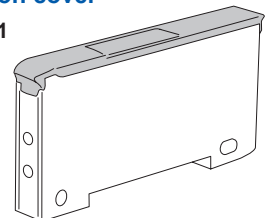

Amplifier mounting bracket

- **MS-DIN-4**

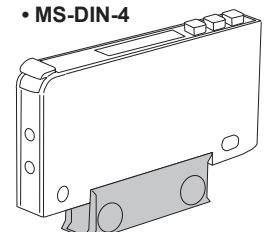

FIBER SENSORS

LASER SENSORS

PHOTO-ELECTRIC SENSORS

MICRO PHOTO-ELECTRIC SENSORS

AREA SENSORS

SAFETY COMPONENTS

PRESSURE SENSORS

INDUCTIVE PROXIMITY SENSORS

PARTICULAR USE SENSORS

SENSOR OPTIONS

WIRE-SAVING SYSTEMS

MEASUREMENT SENSORS

STATIC CONTROL DEVICES

LASER MARKERS

Selection Guide

Fibers

FT / FD / FR

Fiber Sensor Amplifiers

FX-100

FX-300

FX-410

FX-311

FX-11A

FX-301-F

Other Products

LIST OF FIBERS**Thru-beam type (one pair set)** 

Fibers are listed in alphabetic order. Refer to p.63~ "Fiber Selection" for details of each fiber.

Model No.	Sensing range (mm in) (Note 1)		Dimensions
	Standard type FX-101 □	Long sensing range type FX-102 □	
FT-A8	1,500 59.055	3,500 137.795 (Note 2)	P.106
FT-A30	3,500 137.795 (Note 2)	3,500 137.795 (Note 2)	P.106
FT-AFM2	280 11.024	720 28.346	P.106
FT-AFM2E	240 9.449	670 26.378	P.106
FT-B8	400 15.748	1,150 45.276	P.106
FT-E12	6 0.236	19 0.748	P.106
FT-E22	15 0.591	60 2.362	P.106
FT-FM2			P.106
FT-FM2S	300 11.811	800 31.496	P.106
FT-FM2S4			P.106
FT-FM10L	9,300 366.141	15,000 590.550	P.106
FT-H13-FM2	250 9.843	700 27.559	P.106
FT-H20-J20-S (Note 3)			P.107
FT-H20-J30-S (Note 3)	135 5.315	420 16.535	P.107
FT-H20-J50-S (Note 3)			P.107
FT-H20-M1	210 8.268	540 21.260	P.107
FT-H20-VJ50-S (Note 3)			P.107
FT-H20-VJ80-S (Note 3)	150 5.906	500 19.685	P.107
FT-H20W-M1	100 3.937	300 11.811	P.107
FT-H30-M1V-S (Note 4)	110 4.331	280 11.024	P.107
FT-H35-M2			P.107
FT-H35-M2S6	170 6.693	490 19.291	P.107
FT-HL80Y	990 38.976	2,340 92.126	P.107
FT-K8	1,000 39.370	3,000 118.110	P.108
FT-KV1	135 5.315	500 19.685	P.108
FT-KV8	1,000 39.370	3,000 118.110	P.108
FT-L80Y	1,100 43.307	2,600 102.362	P.108
FT-NFM2			P.108
FT-NFM2S	130 5.118	280 11.024	P.108
FT-NFM2S4			P.108
FT-P2	120 4.724	330 12.992	P.108
FT-P40	80 3.150	240 9.449	P.108
FT-P60	130 5.118	300 11.811	P.108
FT-P80	230 9.055	650 25.591	P.108
FT-P81X	260 10.236	800 31.496	P.108

Model No.	Sensing range (mm in) (Note 1)		Dimensions
	Standard type FX-101 □	Long sensing range type FX-102 □	
FT-PS1	40 1.575	90 3.543	P.109
FT-R80	180 7.087	430 16.929	P.109
FT-SFM2	300 11.811	800 31.496	P.109
FT-SFM2L	760 29.921	2,400 94.488	P.109
FT-SFM2SV2	180 7.087	470 18.504	P.109
FT-SNFM2	130 5.118	280 11.024	P.109
FT-T80	300 11.811	800 31.496	P.109
FT-V10	1,000 39.370	2,350 92.520	P.109
FT-V22	140 5.512	380 14.961	P.109
FT-V41	40 1.575	120 4.724	P.109
FT-V80Y	340 13.386	800 31.496	P.109
FT-W4	80 3.150	220 8.661	P.109
FT-W8	260 10.236	650 25.591	P.110
FT-WA8	1,500 59.055	3,500 137.795 (Note 2)	P.110
FT-WA30	3,500 137.795 (Note 2)	3,500 137.795 (Note 2)	P.110
FT-WKV8	700 27.559	2,200 86.614	P.110
FT-WR80	215 8.465	570 22.441	P.110
FT-WR80L	430 16.929	1,150 45.276	P.110
FT-WS3	150 5.906	600 23.622	P.110
FT-WS4	80 3.150	220 8.661	P.110
FT-WS8	260 10.236	650 25.591	P.110
FT-WS8L	600 23.622	1,500 59.055	P.110
FT-WV42	30 1.181	80 3.150	P.110
FT-WZ4	230 9.055	670 26.378	P.110
FT-WZ4HB	80 3.150	230 9.055	P.111
FT-WZ7	330 12.992	1,000 39.370	P.111
FT-WZ7HB	190 7.480	580 22.835	P.111
FT-WZ8	330 12.992	950 37.402	P.111
FT-WZ8E	700 27.559	2,100 82.677	P.111
FT-WZ8H	1,200 47.244	2,800 110.236	P.111
FT-Z8	360 14.173	1,000 39.370	P.111
FT-Z8E	800 31.496	1,850 72.835	P.111
FT-Z8H	1,400 55.118	3,100 122.047	P.111
FT-Z802Y	520 20.472	3,100 122.047	P.111

Notes: 1) Please take care that the sensing range of the free-cut type fiber may be reduced by 20 % max. depending upon how the fiber is cut.

2) The fiber cable length practically limits the sensing range to 3,500 mm **137.795 in** long.

3) Heat-resistant joint fibers and ordinary-temperature side fibers (**FT-FM2**) are sold as a set. Please refer to p.93~ for details.

4) Sold as a set comprising vacuum-resistant type fiber + photo-terminal (**FV-BR1**) + fiber at atmospheric side (**FT-J8**). Please refer to p.91~ for details.

LIST OF FIBERS

Retroreflective type 

Fibers are listed in alphabetic order. Refer to p.63~ “Fiber Selection” for details of each fiber.

Model No.	Sensing range (mm in) (Note 1, 2)		Dimensions
	Standard type FX-101 □	Long sensing range type FX-102 □	
FR-KV1	15 to 200 0.591 to 7.874	15 to 360 0.591 to 14.173	P.112
FR-KZ21	200 7.874	200 7.874	P.112
FR-KZ21E	200 7.874	200 7.874	P.112
FR-WKZ11	100 to 550 3.937 to 21.654	100 to 830 3.937 to 32.677	P.112

Notes: 1) Please take care that the sensing range of the free-cut type fiber may be reduced by 20 % max. depending upon how the fiber is cut. The sensing range of **FR-WKZ11** is specified for the **RF-13**. The sensing range of **FR-KZ21**, **FR-KZ21E** and **FR-KV1** is specified for the attached reflector. The sensing ranges when using in combination with the **FR-WKZ11** reflector (optional) are given in the below table.

Reflector \ Amplifier	FX-101 □	FX-102 □
FR-WKZ11 + RF-210	100 to 700 3.937 to 27.559	100 to 1,100 3.937 to 43.307
FR-WKZ11 + RF-220	100 to 1,300 3.937 to 51.181	100 to 2,600 3.937 to 102.362
FR-WKZ11 + RF-230	100 to 2,000 3.937 to 78.740	100 to 4,000 3.937 to 157.480

- 2) The sensing range of **FR-WKZ11** is the possible setting range for the reflector or reflective tape. The fiber can detect an object less than 100 mm **3.937 in** away. However, note that if there are any white or highly-reflective surfaces near the fiber head, reflected incident light may affect the fiber head. If this occurs, adjust the threshold value of the amplifier unit before use. The sensing range of **FR-KZ21(E)** is the possible setting range for the reflector. However, if setting the fiber to detect objects passing within 0 to 20 mm **0 to 0.787 in** from the fiber head, unstable detection may result. The sensing range of **FR-KV1** is the possible setting range for the reflector. The fiber can detect an object less than 15 mm **0.591 in** away.

Reflective type 

Fibers are listed in alphabetic order. Refer to “Fiber Selection p.63~” for details of each fiber.

Model No.	Sensing range (mm in) (Note 1, 2)		Dimensions
	Standard type FX-101 □	Long sensing range type FX-102 □	
FD-A15	125 4.921	250 9.843	P.113
FD-AFM2	105 4.134	285 11.220	P.113
FD-AFM2E	85 3.346	245 9.646	P.113
FD-B8	170 6.693	440 17.323	P.113
FD-E12	3.5 0.138	13 0.512	P.113
FD-E22	16 0.630	45 1.772	P.113
FD-EG1	18 0.709	50 1.969	P.113
FD-EG2	10 0.394	30 1.181	P.113
FD-EG3	7 0.276	22 0.866	P.113
FD-EN500S1	1 0.039	4 0.157	P.113
FD-ENM1S1	15 0.591	48 1.890	P.114
FD-F4	Applicable pipe diameter: Outer dia. ø6 to ø26 mm ø0.236 to ø1.024 in transparent pipe [PFA (fluorine resin) or equivalently transparent pipe, wall thickness 1 mm 0.039 in]		P.114
FD-F41	Applicable pipe diameter: Outer dia. ø6 to ø26 mm ø0.236 to ø1.024 in transparent pipe [PVC (vinyl chloride), fluorine resin, polycarbonate, acrylic, glass, wall thickness 1 to 3 mm 0.039 to 0.118 in]		P.114
FD-F8Y	—————		P.114
FD-FM2	100 3.937	410 16.142	P.114
FD-FM2S	100 3.937	345 13.583	P.114
FD-FM2S4			P.114
FD-G4	50 1.969	120 4.724	P.114

Model No.	Sensing range (mm in) (Note 1, 2)		Dimensions
	Standard type FX-101 □	Long sensing range type FX-102 □	
FD-G6	50 1.969	120 4.724	P.114
FD-G6X	45 1.772	160 6.299	P.114
FD-H13-FM2	100 3.937	280 11.024	P.114
FD-H18-L31	0 to 10 0 to 0.394	0 to 25 0 to 0.984	P.115
FD-H20-21	90 3.543	280 11.024	P.115
FD-H20-M1	120 4.724	300 11.811	P.115
FD-H30-KZ1V-S (Note 3)	25 to 80 0.984 to 3.150	10 to 220 0.394 to 8.661	P.115
FD-H30-L32	2 to 9 0.079 to 0.354	0 to 17 0 to 0.669	P.115
FD-H30-L32V-S (Note 3)	2.5 to 6.5 0.098 to 0.256	0 to 11 0 to 0.433	P.115
FD-H35-20S	85 3.346	200 7.874	P.116
FD-H35-M2	75 2.953	280 11.024	P.116
FD-H35-M2S6			P.116
FD-L4	5 to 8 0.197 to 0.315 (Convergent point 6 0.236)	1 to 17 0.039 to 0.669 (Convergent point 6 0.236)	P.116
FD-L41	3 to 14 0.118 to 0.551 (Convergent point 8 0.315)	1.5 to 16 0.059 to 0.630 (Convergent point 8 0.315)	P.116
FD-L43	0 to 19 0 to 0.748	0 to 25 0 to 0.984	P.116
FD-L44	0 to 6 0 to 0.236	0 to 8 0 to 0.315	P.116
FD-L44S	0 to 4.5 0 to 0.177	0 to 5.5 0 to 0.217	P.116
FD-L45	0 to 40 0 to 1.575	0 to 50 0 to 1.969	P.116
FD-L46	16 to 30 0.630 to 1.181	12 to 50 0.472 to 1.969	P.116
FD-NFM2	35 1.378	100 3.937	P.117
FD-NFM2S			P.117
FD-NFM2S4			P.117
FD-P2	25 0.984	65 2.559	P.117

- Notes: 1) The standard sensing objects of the sensing ranges vary depending on the fibers. Refer to p.71~ for details.
- 2) Please take care that the sensing range of the free-cut type fiber may be reduced by 20 % max. depending upon how the fiber is cut.
- 3) Sold as a set comprising vacuum-resistant type fiber + photo-terminal (**FV-BR1**) + fiber at atmospheric side (**FT-J8**). Please refer to p.91~ for details.

FIBER SENSORS

LASER SENSORS

PHOTO-ELECTRIC SENSORS

MICRO PHOTO-ELECTRIC SENSORS

AREA SENSORS

SAFETY COMPONENTS

PRESSURE SENSORS

INDUCTIVE PROXIMITY SENSORS

PARTICULAR USE SENSORS

SENSOR OPTIONS

WIRE- SAVING SYSTEMS

MEASURE- MENT SENSORS

STATIC CONTROL DEVICES

LASER MARKERS

Selection Guide
Fibers

FT / FD / FR

Fiber Sensor Amplifiers

FX-100

FX-300

FX-410

FX-311

FX-11A

FX-301-F

Other Products

LIST OF FIBERS

Reflective type



Fibers are listed in alphabetic order. Refer to "Fiber Selection p.63~" for details of each fiber.

Model No.	Sensing range (mm in) (Note 1, 2)		Dimensions
	Standard type FX-101 □	Long sensing range type FX-102 □	
FD-P40	8 0.315	30 1.181	P.117
FD-P50	45 1.772	150 5.906	P.117
FD-P60	45 1.772	150 5.906	P.117
FD-P80	90 3.543	200 7.874	P.117
FD-P81X	70 2.756	220 8.661	P.117
FD-R80	70 2.756	180 7.087	P.117
FD-S80	100 3.937	345 13.583	P.117
FD-SFM2SV2	30 1.181	90 3.543	P.117
FD-SNFM2	35 1.378	100 3.937	P.118
FD-T40	35 1.378	100 3.937	P.118
FD-T80	100 3.937	345 13.583	P.118
FD-V41	25 0.984	70 2.756	P.118
FD-W8	80 3.150	230 9.055	P.118
FD-W44	15 0.591	40 1.575	P.118

Model No.	Sensing range (mm in) (Note 1, 2)		Dimensions
	Standard type FX-101 □	Long sensing range type FX-102 □	
FD-WG4	28 1.102	75 2.953	P.118
FD-WKZ1	20 to 180 0.787 to 7.087	20 to 480 0.787 to 18.898	P.118
FD-WL41	7 to 12 0.276 to 0.472 (Convergent point 8 0.315)	6 to 13.5 0.236 to 0.531 (Convergent point 8 0.315)	P.118
FD-WL48	1 to 4.5 0.039 to 0.177	0.5 to 6.5 0.020 to 0.256	P.119
FD-WS8	80 3.150	230 9.055	P.119
FD-WSG4	28 1.102	75 2.953	P.119
FD-WT4	15 0.591	40 1.575	P.119
FD-WT8	80 3.150	230 9.055	P.119
FD-WV42	6 0.236	20 0.787	P.119
FD-WZ4	2 to 20 0.079 to 0.787	1 to 70 0.039 to 2.756	P.119
FD-WZ4HB			P.119
FD-WZ7	1 to 55 0.039 to 2.165	160 6.299	P.119
FD-WZ7HB	1 to 60 0.039 to 2.362	0.5 to 180 0.020 to 7.087	P.119

Notes: 1) The standard sensing objects of the sensing ranges vary depending on the fibers. Refer to p.71~ for details.



2) Please take care that the sensing range of the free-cut type fiber may be reduced by 20 % max. depending upon how the fiber is cut.

3) Sold as a set comprising vacuum-resistant type fiber + photo-terminal (**FV-BR1**) + fiber at atmospheric side (**FT-J8**). Please refer to p.91~ for details.

FIBER OPTIONS

Lens (For thru-beam type fiber)

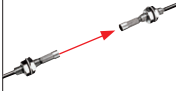
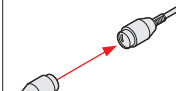
The dimensions are on p.120~.

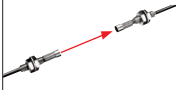
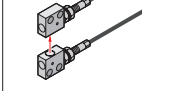
Designation	Model No.	Description																																													
For thru-beam type fiber	Expansion lens (Note 1)	FX-LE1	 <p>Increases the sensing range by 5 times or more.</p> <ul style="list-style-type: none"> Ambient temperature: -60 to +350 °C -76 to +662 °F (Note 3) 																																												
	Super-expansion lens (Note 1)	FX-LE2	 <p>Tremendously increases the sensing range with large diameter lenses.</p> <ul style="list-style-type: none"> Ambient temperature: -60 to +350 °C -76 to +662 °F (Note 3) 																																												
	Side-view lens	FX-SV1	 <p>Beam axis is bent by 90°.</p> <ul style="list-style-type: none"> Ambient temperature: -60 to +300 °C -76 to +572 °F (Note 3) 																																												
	Expansion lens for vacuum-resistant fiber (Note 1)	FV-LE1	 <p>Sensing range increases by 4 times or more.</p> <ul style="list-style-type: none"> Ambient temperature: -60 to +350 °C -76 to +662 °F (Note 3) 																																												
	Side-view lens for vacuum-resistant fiber	FV-SV2	 <p>Beam axis is bent by 90°.</p> <ul style="list-style-type: none"> Ambient temperature: -60 to +300 °C -76 to +572 °F (Note 3) 																																												
		<p>Sensing range (mm in) [Lens on both sides]</p> <table border="1"> <thead> <tr> <th>Fiber</th> <th>Amplifier</th> <th>FX-101□</th> <th>FX-102□</th> </tr> </thead> <tbody> <tr> <td>FT-B8</td> <td></td> <td>2,200 86.614</td> <td>3,500 137.795 (Note 2)</td> </tr> <tr> <td>FT-FM2, FT-T80</td> <td></td> <td>3,000 118.110</td> <td>3,500 137.795 (Note 2)</td> </tr> <tr> <td>FT-R80</td> <td></td> <td>1,900 74.803</td> <td>3,500 137.795 (Note 2)</td> </tr> <tr> <td>FT-W8</td> <td></td> <td>3,000 118.110</td> <td>3,500 137.795 (Note 2)</td> </tr> <tr> <td>FT-P80, FT-P60</td> <td></td> <td>3,500 137.795 (Note 2)</td> <td>3,500 137.795 (Note 2)</td> </tr> <tr> <td>FT-P81X</td> <td></td> <td>1,600 62.992 (Note 2)</td> <td>1,600 62.992 (Note 2)</td> </tr> <tr> <td>FT-H35-M2</td> <td></td> <td>2,000 78.740</td> <td>3,500 137.795 (Note 2)</td> </tr> <tr> <td>FT-H20W-M1</td> <td></td> <td>1,300 51.181</td> <td>1,600 62.992 (Note 2)</td> </tr> <tr> <td>FT-H20-M1</td> <td></td> <td>1,600 62.992 (Note 2)</td> <td>1,600 62.992 (Note 2)</td> </tr> <tr> <td>FT-H20-J20-S, FT-H20-J30-S, FT-H20-J50-S</td> <td></td> <td>1,000 39.370</td> <td>3,500 137.795 (Note 2)</td> </tr> </tbody> </table>		Fiber	Amplifier	FX-101□	FX-102□	FT-B8		2,200 86.614	3,500 137.795 (Note 2)	FT-FM2, FT-T80		3,000 118.110	3,500 137.795 (Note 2)	FT-R80		1,900 74.803	3,500 137.795 (Note 2)	FT-W8		3,000 118.110	3,500 137.795 (Note 2)	FT-P80, FT-P60		3,500 137.795 (Note 2)	3,500 137.795 (Note 2)	FT-P81X		1,600 62.992 (Note 2)	1,600 62.992 (Note 2)	FT-H35-M2		2,000 78.740	3,500 137.795 (Note 2)	FT-H20W-M1		1,300 51.181	1,600 62.992 (Note 2)	FT-H20-M1		1,600 62.992 (Note 2)	1,600 62.992 (Note 2)	FT-H20-J20-S, FT-H20-J30-S, FT-H20-J50-S		1,000 39.370	3,500 137.795 (Note 2)
Fiber	Amplifier	FX-101□	FX-102□																																												
FT-B8		2,200 86.614	3,500 137.795 (Note 2)																																												
FT-FM2, FT-T80		3,000 118.110	3,500 137.795 (Note 2)																																												
FT-R80		1,900 74.803	3,500 137.795 (Note 2)																																												
FT-W8		3,000 118.110	3,500 137.795 (Note 2)																																												
FT-P80, FT-P60		3,500 137.795 (Note 2)	3,500 137.795 (Note 2)																																												
FT-P81X		1,600 62.992 (Note 2)	1,600 62.992 (Note 2)																																												
FT-H35-M2		2,000 78.740	3,500 137.795 (Note 2)																																												
FT-H20W-M1		1,300 51.181	1,600 62.992 (Note 2)																																												
FT-H20-M1		1,600 62.992 (Note 2)	1,600 62.992 (Note 2)																																												
FT-H20-J20-S, FT-H20-J30-S, FT-H20-J50-S		1,000 39.370	3,500 137.795 (Note 2)																																												
		<p>Sensing range (mm in) [Lens on both sides]</p> <table border="1"> <thead> <tr> <th>Fiber</th> <th>Amplifier</th> <th>FX-101□</th> <th>FX-102□</th> </tr> </thead> <tbody> <tr> <td>FT-B8, FT-FM2, FT-R80, FT-W8, FT-P80, FT-P60</td> <td></td> <td>3,500 137.795 (Note 2)</td> <td>3,500 137.795 (Note 2)</td> </tr> <tr> <td>FT-P81X</td> <td></td> <td>1,600 62.992 (Note 2)</td> <td>1,600 62.992 (Note 2)</td> </tr> <tr> <td>FT-H35-M2</td> <td></td> <td>3,500 137.795 (Note 2)</td> <td>3,500 137.795 (Note 2)</td> </tr> <tr> <td>FT-H20W-M1, FT-H20-M1</td> <td></td> <td>1,600 62.992 (Note 2)</td> <td>1,600 62.992 (Note 2)</td> </tr> <tr> <td>FT-H13-FM2</td> <td></td> <td>3,500 137.795 (Note 2)</td> <td>3,500 137.795 (Note 2)</td> </tr> <tr> <td>FT-H20-J20-S, FT-H20-J30-S, FT-H20-J50-S</td> <td></td> <td>3,500 137.795 (Note 2)</td> <td>3,500 137.795 (Note 2)</td> </tr> </tbody> </table>		Fiber	Amplifier	FX-101□	FX-102□	FT-B8, FT-FM2, FT-R80, FT-W8, FT-P80, FT-P60		3,500 137.795 (Note 2)	3,500 137.795 (Note 2)	FT-P81X		1,600 62.992 (Note 2)	1,600 62.992 (Note 2)	FT-H35-M2		3,500 137.795 (Note 2)	3,500 137.795 (Note 2)	FT-H20W-M1, FT-H20-M1		1,600 62.992 (Note 2)	1,600 62.992 (Note 2)	FT-H13-FM2		3,500 137.795 (Note 2)	3,500 137.795 (Note 2)	FT-H20-J20-S, FT-H20-J30-S, FT-H20-J50-S		3,500 137.795 (Note 2)	3,500 137.795 (Note 2)																
Fiber	Amplifier	FX-101□	FX-102□																																												
FT-B8, FT-FM2, FT-R80, FT-W8, FT-P80, FT-P60		3,500 137.795 (Note 2)	3,500 137.795 (Note 2)																																												
FT-P81X		1,600 62.992 (Note 2)	1,600 62.992 (Note 2)																																												
FT-H35-M2		3,500 137.795 (Note 2)	3,500 137.795 (Note 2)																																												
FT-H20W-M1, FT-H20-M1		1,600 62.992 (Note 2)	1,600 62.992 (Note 2)																																												
FT-H13-FM2		3,500 137.795 (Note 2)	3,500 137.795 (Note 2)																																												
FT-H20-J20-S, FT-H20-J30-S, FT-H20-J50-S		3,500 137.795 (Note 2)	3,500 137.795 (Note 2)																																												
		<p>Sensing range (mm in) [Lens on both sides]</p> <table border="1"> <thead> <tr> <th>Fiber</th> <th>Amplifier</th> <th>FX-101□</th> <th>FX-102□</th> </tr> </thead> <tbody> <tr> <td>FT-B8</td> <td></td> <td>530 20.866</td> <td>1,450 57.087</td> </tr> <tr> <td>FT-FM2, FT-T80</td> <td></td> <td>550 21.654</td> <td>1,700 66.929</td> </tr> <tr> <td>FT-W8</td> <td></td> <td>450 17.717</td> <td>1,300 51.181</td> </tr> <tr> <td>FT-P80</td> <td></td> <td>420 16.535</td> <td>1,400 55.118</td> </tr> <tr> <td>FT-P60</td> <td></td> <td>300 11.811</td> <td>850 33.465</td> </tr> <tr> <td>FT-P81X</td> <td></td> <td>550 21.654</td> <td>1,700 66.929</td> </tr> <tr> <td>FT-H35-M2</td> <td></td> <td>280 11.024</td> <td>800 31.496</td> </tr> <tr> <td>FT-H20W-M1</td> <td></td> <td>140 5.512</td> <td>400 15.748</td> </tr> <tr> <td>FT-H20-M1</td> <td></td> <td>280 11.024</td> <td>840 33.071</td> </tr> <tr> <td>FT-H20-J20-S, FT-H20-J30-S, FT-H20-J50-S</td> <td></td> <td>150 5.906</td> <td>410 16.142</td> </tr> </tbody> </table>		Fiber	Amplifier	FX-101□	FX-102□	FT-B8		530 20.866	1,450 57.087	FT-FM2, FT-T80		550 21.654	1,700 66.929	FT-W8		450 17.717	1,300 51.181	FT-P80		420 16.535	1,400 55.118	FT-P60		300 11.811	850 33.465	FT-P81X		550 21.654	1,700 66.929	FT-H35-M2		280 11.024	800 31.496	FT-H20W-M1		140 5.512	400 15.748	FT-H20-M1		280 11.024	840 33.071	FT-H20-J20-S, FT-H20-J30-S, FT-H20-J50-S		150 5.906	410 16.142
Fiber	Amplifier	FX-101□	FX-102□																																												
FT-B8		530 20.866	1,450 57.087																																												
FT-FM2, FT-T80		550 21.654	1,700 66.929																																												
FT-W8		450 17.717	1,300 51.181																																												
FT-P80		420 16.535	1,400 55.118																																												
FT-P60		300 11.811	850 33.465																																												
FT-P81X		550 21.654	1,700 66.929																																												
FT-H35-M2		280 11.024	800 31.496																																												
FT-H20W-M1		140 5.512	400 15.748																																												
FT-H20-M1		280 11.024	840 33.071																																												
FT-H20-J20-S, FT-H20-J30-S, FT-H20-J50-S		150 5.906	410 16.142																																												
		<p>Sensing range (mm in) [Lens on both sides] (Note 4)</p> <table border="1"> <thead> <tr> <th>Fiber</th> <th>Amplifier</th> <th>FX-101□</th> <th>FX-102□</th> </tr> </thead> <tbody> <tr> <td>FT-H30-M1V</td> <td></td> <td>450 17.717</td> <td>1,600 62.992</td> </tr> </tbody> </table>		Fiber	Amplifier	FX-101□	FX-102□	FT-H30-M1V		450 17.717	1,600 62.992																																				
Fiber	Amplifier	FX-101□	FX-102□																																												
FT-H30-M1V		450 17.717	1,600 62.992																																												
		<p>Sensing range (mm in) [Lens on both sides] (Note 4)</p> <table border="1"> <thead> <tr> <th>Fiber</th> <th>Amplifier</th> <th>FX-101□</th> <th>FX-102□</th> </tr> </thead> <tbody> <tr> <td>FT-H30-M1V</td> <td></td> <td>450 17.717</td> <td>1,600 62.992</td> </tr> </tbody> </table>		Fiber	Amplifier	FX-101□	FX-102□	FT-H30-M1V		450 17.717	1,600 62.992																																				
Fiber	Amplifier	FX-101□	FX-102□																																												
FT-H30-M1V		450 17.717	1,600 62.992																																												

- Notes: 1) Be careful when installing the thru-beam type fiber equipped with the expansion lens, as the beam envelope becomes narrow and alignment is difficult. Especially when installing a fiber with many cores (sharp bending fibers and heat-resistant glass fiber), please be sure to use it only after you have adjusted it sufficiently.
- 2) The fiber cable length practically limits the sensing range to 3,500 mm **137.795 in** long (**FT-H20W-M1, FT-P81X** and **FT-H20-M1**: 1,600 mm **62.992 in**).
- 3) For details on the ambient temperatures for the fibers which being combined, refer to p.101~.
- 4) The fiber cable length for the **FT-H30-M1V** is 1 m **3.281 ft**. The sensing ranges in **FX-102□** (long sensing range type) take into account the length of the **FT-J8** atmospheric side fiber.

FIBER SENSORS
LASER SENSORS
PHOTO-ELECTRIC SENSORS
MICRO PHOTO-ELECTRIC SENSORS
AREA SENSORS
SAFETY COMPONENTS
PRESSURE SENSORS
INDUCTIVE PROXIMITY SENSORS
PARTICULAR USE SENSORS
SENSOR OPTIONS
WIRE- SAVING SYSTEMS
MEASURE- MENT SENSORS
STATIC CONTROL DEVICES
LASER MARKERS
Selection Guide
Fibers
FT / FD / FR
Fiber Sensor Amplifiers
FX-100
FX-300
FX-410
FX-311
FX-11A
FX-301-F
Other Products

FIBER OPTIONS

Lens (For reflective type fiber)

The dimensions are on p.121~.

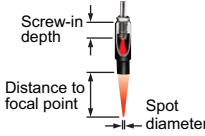
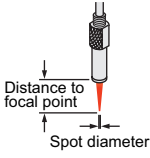
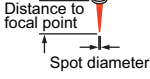
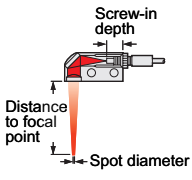
Designation	Model No.	Description																
For reflective type fiber	Pinpoint spot lens FX-MR1		Pinpoint spot of $\varnothing 0.5$ mm $\varnothing 0.020$ in. Enables detection of minute objects or small marks. • Distance to focal point: 6 ± 1 mm 0.236 ± 0.039 in • Applicable fibers: FD-WG4, FD-G4 • Ambient temperature: -40 to $+70$ °C -40 to $+158$ °F (Note 2)															
	Zoom lens FX-MR2		The spot diameter is adjustable from $\varnothing 0.7$ to $\varnothing 2$ mm $\varnothing 0.028$ to $\varnothing 0.079$ in according to how much the fiber is screwed in. • Applicable fibers: FD-WG4, FD-G4 • Ambient temperature: -40 to $+70$ °C -40 to $+158$ °F (Note 2) • Accessory: MS-EX-3 (mounting bracket)															
	Finest spot lens FX-MR3		Extremely fine spot of $\varnothing 0.3$ mm $\varnothing 0.012$ in approx. achieved. • Applicable fibers: FD-WG4, FD-G4, FD-EG1, FD-EG2, FD-EG3, FD-G6X, FD-G6 • Ambient temperature: -40 to $+70$ °C -40 to $+158$ °F (Note 2)															
	Finest spot lens FX-MR6		Extremely fine spot of $\varnothing 0.1$ mm $\varnothing 0.004$ in approx. achieved. • Applicable fibers: FD-WG4, FD-G4, FD-EG1, FD-EG2, FD-EG3, FD-G6X, FD-G6 • Ambient temperature: -20 to $+60$ °C -4 to $+140$ °F (Note 2)															
	Zoom lens (Side-view type) FX-MR5		FX-MR2 is converted into a side-view type and can be mounted in a very small space. • Applicable fibers: FD-WG4, FD-G4 • Ambient temperature: -40 to $+70$ °C -40 to $+158$ °F (Note 2)															
		<p>Sensing range for FX-101□ (mm in) (Note 1)</p> <table border="1"> <thead> <tr> <th>Screw-in depth</th> <th>Distance to focal point</th> <th>Spot diameter</th> </tr> </thead> <tbody> <tr> <td>7 mm 0.276 in</td> <td>18.5 0.728 approx.</td> <td>$\varnothing 0.7$ $\varnothing 0.028$</td> </tr> <tr> <td>12 mm 0.472 in</td> <td>27 1.063 approx.</td> <td>$\varnothing 1.2$ $\varnothing 0.047$</td> </tr> <tr> <td>14 mm 0.551 in</td> <td>43 1.693 approx.</td> <td>$\varnothing 2.0$ $\varnothing 0.079$</td> </tr> </tbody> </table>		Screw-in depth	Distance to focal point	Spot diameter	7 mm 0.276 in	18.5 0.728 approx.	$\varnothing 0.7$ $\varnothing 0.028$	12 mm 0.472 in	27 1.063 approx.	$\varnothing 1.2$ $\varnothing 0.047$	14 mm 0.551 in	43 1.693 approx.	$\varnothing 2.0$ $\varnothing 0.079$			
Screw-in depth	Distance to focal point	Spot diameter																
7 mm 0.276 in	18.5 0.728 approx.	$\varnothing 0.7$ $\varnothing 0.028$																
12 mm 0.472 in	27 1.063 approx.	$\varnothing 1.2$ $\varnothing 0.047$																
14 mm 0.551 in	43 1.693 approx.	$\varnothing 2.0$ $\varnothing 0.079$																
		<p>Sensing range for FX-101□ (mm in) (Note 1)</p> <table border="1"> <thead> <tr> <th>Fiber model No.</th> <th>Distance to focal point</th> <th>Spot diameter</th> </tr> </thead> <tbody> <tr> <td>FD-EG3</td> <td>7.5 ± 0.5 0.295 ± 0.020</td> <td>$\varnothing 0.15$ $\varnothing 0.006$ approx.</td> </tr> <tr> <td>FD-EG2</td> <td>7.5 ± 0.5 0.295 ± 0.020</td> <td>$\varnothing 0.2$ $\varnothing 0.008$ approx.</td> </tr> <tr> <td>FD-EG1</td> <td>7.5 ± 0.5 0.295 ± 0.020</td> <td>$\varnothing 0.3$ $\varnothing 0.012$ approx.</td> </tr> <tr> <td>FD-WG4/G4, FD-G6X/G6</td> <td>7.5 ± 0.5 0.295 ± 0.020</td> <td>$\varnothing 0.5$ $\varnothing 0.020$ approx.</td> </tr> </tbody> </table>		Fiber model No.	Distance to focal point	Spot diameter	FD-EG3	7.5 ± 0.5 0.295 ± 0.020	$\varnothing 0.15$ $\varnothing 0.006$ approx.	FD-EG2	7.5 ± 0.5 0.295 ± 0.020	$\varnothing 0.2$ $\varnothing 0.008$ approx.	FD-EG1	7.5 ± 0.5 0.295 ± 0.020	$\varnothing 0.3$ $\varnothing 0.012$ approx.	FD-WG4/G4, FD-G6X/G6	7.5 ± 0.5 0.295 ± 0.020	$\varnothing 0.5$ $\varnothing 0.020$ approx.
Fiber model No.	Distance to focal point	Spot diameter																
FD-EG3	7.5 ± 0.5 0.295 ± 0.020	$\varnothing 0.15$ $\varnothing 0.006$ approx.																
FD-EG2	7.5 ± 0.5 0.295 ± 0.020	$\varnothing 0.2$ $\varnothing 0.008$ approx.																
FD-EG1	7.5 ± 0.5 0.295 ± 0.020	$\varnothing 0.3$ $\varnothing 0.012$ approx.																
FD-WG4/G4, FD-G6X/G6	7.5 ± 0.5 0.295 ± 0.020	$\varnothing 0.5$ $\varnothing 0.020$ approx.																
		<p>Sensing range for FX-101□ (mm in) (Note 1)</p> <table border="1"> <thead> <tr> <th>Fiber model No.</th> <th>Distance to focal point</th> <th>Spot diameter</th> </tr> </thead> <tbody> <tr> <td>FD-EG3</td> <td>7 ± 0.5 0.276 ± 0.020</td> <td>$\varnothing 0.1$ $\varnothing 0.004$ approx.</td> </tr> <tr> <td>FD-EG2</td> <td>7 ± 0.5 0.276 ± 0.020</td> <td>$\varnothing 0.15$ $\varnothing 0.006$ approx.</td> </tr> <tr> <td>FD-EG1</td> <td>7 ± 0.5 0.276 ± 0.020</td> <td>$\varnothing 0.2$ $\varnothing 0.008$ approx.</td> </tr> <tr> <td>FD-WG4/G4, FD-G6X/G6</td> <td>7 ± 0.5 0.276 ± 0.020</td> <td>$\varnothing 0.4$ $\varnothing 0.016$ approx.</td> </tr> </tbody> </table>		Fiber model No.	Distance to focal point	Spot diameter	FD-EG3	7 ± 0.5 0.276 ± 0.020	$\varnothing 0.1$ $\varnothing 0.004$ approx.	FD-EG2	7 ± 0.5 0.276 ± 0.020	$\varnothing 0.15$ $\varnothing 0.006$ approx.	FD-EG1	7 ± 0.5 0.276 ± 0.020	$\varnothing 0.2$ $\varnothing 0.008$ approx.	FD-WG4/G4, FD-G6X/G6	7 ± 0.5 0.276 ± 0.020	$\varnothing 0.4$ $\varnothing 0.016$ approx.
Fiber model No.	Distance to focal point	Spot diameter																
FD-EG3	7 ± 0.5 0.276 ± 0.020	$\varnothing 0.1$ $\varnothing 0.004$ approx.																
FD-EG2	7 ± 0.5 0.276 ± 0.020	$\varnothing 0.15$ $\varnothing 0.006$ approx.																
FD-EG1	7 ± 0.5 0.276 ± 0.020	$\varnothing 0.2$ $\varnothing 0.008$ approx.																
FD-WG4/G4, FD-G6X/G6	7 ± 0.5 0.276 ± 0.020	$\varnothing 0.4$ $\varnothing 0.016$ approx.																
		<p>Sensing range for FX-101□ (mm in) (Note 1)</p> <table border="1"> <thead> <tr> <th>Screw-in depth</th> <th>Distance to focal point</th> <th>Spot diameter</th> </tr> </thead> <tbody> <tr> <td>8 mm 0.315 in</td> <td>13 0.512 approx.</td> <td>$\varnothing 0.5$ $\varnothing 0.020$</td> </tr> <tr> <td>10 mm 0.394 in</td> <td>15 0.591 approx.</td> <td>$\varnothing 0.8$ $\varnothing 0.031$</td> </tr> <tr> <td>14 mm 0.551 in</td> <td>30 1.181 approx.</td> <td>$\varnothing 3.0$ $\varnothing 0.118$</td> </tr> </tbody> </table>		Screw-in depth	Distance to focal point	Spot diameter	8 mm 0.315 in	13 0.512 approx.	$\varnothing 0.5$ $\varnothing 0.020$	10 mm 0.394 in	15 0.591 approx.	$\varnothing 0.8$ $\varnothing 0.031$	14 mm 0.551 in	30 1.181 approx.	$\varnothing 3.0$ $\varnothing 0.118$			
Screw-in depth	Distance to focal point	Spot diameter																
8 mm 0.315 in	13 0.512 approx.	$\varnothing 0.5$ $\varnothing 0.020$																
10 mm 0.394 in	15 0.591 approx.	$\varnothing 0.8$ $\varnothing 0.031$																
14 mm 0.551 in	30 1.181 approx.	$\varnothing 3.0$ $\varnothing 0.118$																

Notes: 1) The sensing ranges are the values when used in combination with **FX-101□** (standard type). Please contact our office for details on sensing ranges for other types of amplifier.
2) For details on the ambient temperatures for the fibers which being combined, refer to p.101~.

SPECIFICATIONS

Refer to p.101~ for fiber specifications.

Item	Model No.	Type	Standard type		Long sensing range type	
				Cable set		Cable set
		NPN output	FX-101(-Z) (Note 4)	FX-101-CC2	FX-102(-Z) (Note 4)	FX-102-CC2
		PNP output	FX-101P(-Z) (Note 4)	FX-101P-CC2	FX-102P(-Z) (Note 4)	FX-102P-CC2
Supply voltage		12 to 24 V DC \pm 10 % Ripple P-P 10 % or less				
Power consumption		Normal operation: 720 mW or less (Current consumption 30 mA or less at 24 V supply voltage) ECO mode: 600 mW or less (Current consumption 25 mA or less at 24 V supply voltage)				
Output			<NPN output type> NPN open-collector transistor • Maximum sink current: 100 mA • Applied voltage: 30 V DC or less (between output and 0 V) • Residual voltage: 1.5 V or less (at 100 mA sink current)		<PNP output type> PNP open-collector transistor • Maximum source current: 100 mA • Applied voltage: 30 V DC or less (between output and +V) • Residual voltage: 1.5 V or less (at 100 mA source current)	
	Output operation		Selectable either Light-ON or Dark-ON, at SET mode			
	Short-circuit protection		Incorporated			
External input		<NPN output type> NPN non-contact input • Signal condition High: +8 V to +V DC or Open Low: 0 to +2 V DC (Source current 0.5 mA or less) • Input impedance: 10 k Ω approx.		<PNP output type> PNP non-contact input • Signal condition High: +4 V to +V DC (Sink current 0.5 to 3 mA) Low: 0 to +0.6 V DC or Open • Input impedance: 10 k Ω approx.		
Response time		Emission frequency 0: 250 μ s or less (factory default setting) Emission frequency 1: 450 μ s or less Emission frequency 2: 500 μ s or less Emission frequency 3: 600 μ s or less		Emission frequency 1: 2.5 ms or less (factory default setting) Emission frequency 2: 2.8 ms or less Emission frequency 3: 3.2 ms or less Emission frequency 4: 5.0 ms or less		
Sensitivity setting		2-level teaching / Limit teaching / Full-auto teaching				
Operation indicator		Orange LED (lights up when the output is ON)				
Digital display		4 digits (green) + 4 digits (red) LCD display				
Fine sensitivity adjustment function		Incorporated				
Timer function		ON-delay / OFF-delay timer, switchable either effective or ineffective [Timer period: 1 ms, 5 ms, 10 ms, 20 ms, 40 ms, 50 ms, 100 ms, 500 ms, 1,000 ms]				
Attenuation function		Incorporated Switchable either effective or ineffective				
Interference prevention function		Incorporated Emission frequency selection method (Note 2) (Functions at emission frequency 1, 2 or 3)		Incorporated Emission frequency selection method (Note 2) (Functions at emission frequency 1, 2, 3 or 4)		
Environmental resistance	Ambient temperature		-10 to +55 °C +14 to +131 °F (If 4 to 7 units are mounted close together: -10 to +50 °C +14 to +122 °F , if 8 to 16 units are mounted close together: -10 to +45 °C +14 to +113 °F) (No dew condensation or icing allowed), Storage: -20 to +70 °C -4 to +158 °F			
	Ambient humidity		35 to 85 % RH, Storage: 35 to 85 % RH			
	Ambient illuminance		Incandescent light: 3,000 lx at the light-receiving face			
	Voltage withstandability		1,000 V AC for one min. between all supply terminals connected together and enclosure (Note 3)			
	Insulation resistance		20 M Ω , or more, with 250 V DC megger between all supply terminals connected together and enclosure (Note 3)			
	Vibration resistance		10 to 150 Hz frequency, 0.75 mm 0.030 in amplitude in X, Y and Z directions for two hours each			
	Shock resistance		98 m/s ² acceleration (10 G approx.) in X, Y and Z directions for five times each			
Emitting element (modulated)		Red LED (Peak emission wavelength: 632 nm 0.025 mil)				
Material		Enclosure: Polycarbonate, Key switch: Polycarbonate, Fiber lock lever: PBT				
Connecting method		Connector (Note 4)				
Cable length		Total length up to 100 m 328.084 ft is possible with 0.3 mm ² , or more, cable.				
Weight		Net weight: 15 g approx. Gross weight: 35 g approx.	Net weight: 15 g approx. Gross weight: 75 g approx.	Net weight: 15 g approx. Gross weight: 35 g approx.	Net weight: 15 g approx. Gross weight: 75 g approx.	
Accessory		—————	CN-14A-C2 (Connector attached cable, 2 m 6.562 ft long): 1pc.	—————	CN-14A-C2 (Connector attached cable, 2 m 6.562 ft long): 1pc.	

Notes: 1) Where measurement conditions have not been specified precisely, the conditions used were an ambient temperature of +23 °C **+73.4 °F**.

2) When using the interference prevention function, set the emission frequencies for the amplifiers to be covered by the interference prevention function to different frequency values.

However, the interference prevention function does not operate at emission frequency 0 (factory default setting) for the **FX-101(P)(-Z)** / **FX-101(P)-CC2**.

3) The voltage withstandability and the insulation resistance values given in the above table are for the amplifier only.

4) Connector attached cable **CN-14A-C2** is not attached to the models that have no "-CC2" at the end of the model Nos.Make sure to use the optional connector attached cable **CN-14A(-R)-C** or the connector **CN-14A**, or a connector manufactured by J.S.T. Mfg., Ltd. (contact: SPHD-001T-P0.5, housing: PAP-04V-S).Model Nos. having the suffix "-Z" are M8 plug-in connector type. Make sure to use the optional M8 attached connector cable **CN-24A-C**.FIBER
SENSORSLASER
SENSORSPHOTO-
ELECTRIC
SENSORSMICRO
PHOTO-
ELECTRIC
SENSORSAREA
SENSORSSAFETY
COMPONENTSPRESSURE
SENSORSINDUCTIVE
PROXIMITY
SENSORSPARTICULAR
USE
SENSORSSENSOR
OPTIONSWIRE-
SAVING
SYSTEMSMEASURE-
MENT
SENSORSSTATIC
CONTROL
DEVICESLASER
MARKERSSelection
Guide

Fibers

FT / FD / FR

Fiber Sensor
Amplifiers**FX-100****FX-300****FX-410****FX-311****FX-11A****FX-301-F**Other
Products

FIBER SENSORS

LASER SENSORS

PHOTO-ELECTRIC SENSORS

MICRO PHOTO-ELECTRIC SENSORS

AREA SENSORS

SAFETY COMPONENTS

PRESSURE SENSORS

INDUCTIVE PROXIMITY SENSORS

PARTICULAR USE SENSORS

SENSOR OPTIONS

WIRE- SAVING SYSTEMS

MEASURE- MENT SENSORS

STATIC CONTROL DEVICES

LASER MARKERS

I/O CIRCUIT AND WIRING DIAGRAMS

FX-10□(-Z/-CC2) NPN output type

I/O circuit diagram

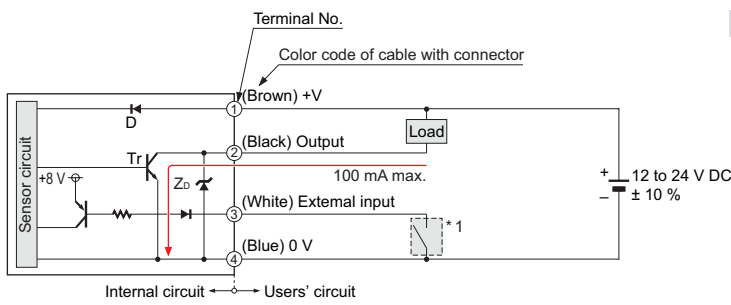

Symbols ... D : Reverse supply polarity protection diode
 ZD: Surge absorption zener diode
 Tr : NPN output transistor

* 1

Non-voltage contact or NPN open-collector transistor

High (+8 V to +V DC, or open): Ineffective
 Low [(0 to +2 V DC (source current 0.5 mA or less)): Effective]

Terminal arrangement diagram

Connector type

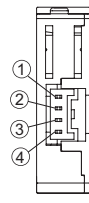

Terminal No.	Function
①	+V
②	Output
③	External input
④	0 V

M8 plug-in connector type

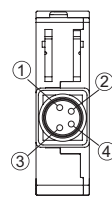

Terminal No.	Function
①	+V
②	Output
③	External input
④	0 V

FX-10□P(-Z/-CC2) PNP output type

I/O circuit diagram

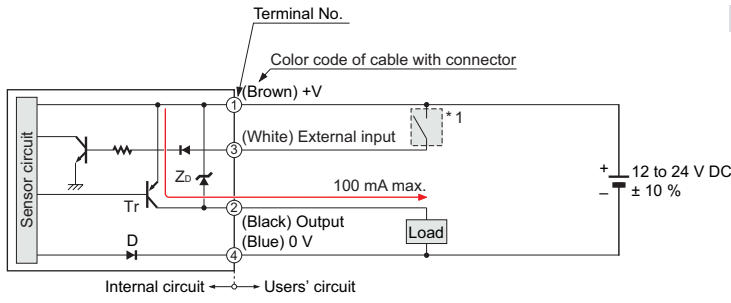

Symbols ... D : Reverse supply polarity protection diode
 ZD: Surge absorption zener diode
 Tr : PNP output transistor

* 1

Non-voltage contact or PNP open-collector transistor

High [+4 V to +V DC (sink current 0.5 to 3 mA)]: Effective
 Low (0 to +0.6 V DC, or open): Ineffective]

Terminal arrangement diagram

Connector type

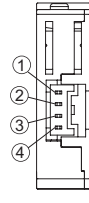

Terminal No.	Function
①	+V
②	Output
③	External input
④	0 V

M8 plug-in connector type

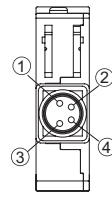

Terminal No.	Function
①	+V
②	Output
③	External input
④	0 V

SENSING CHARACTERISTICS (TYPICAL)

Contact our office for sensing characteristics that are not contained here.

FIBER SENSORS

LASER SENSORS

PHOTO-ELECTRIC SENSORS

MICRO PHOTO-ELECTRIC SENSORS

AREA SENSORS

SAFETY COMPONENTS

PRESSURE SENSORS

INDUCTIVE PROXIMITY SENSORS

PARTICULAR USE SENSORS

SENSOR OPTIONS

WIRE- SAVING SYSTEMS

MEASUREMENT SENSORS

STATIC CONTROL DEVICES

LASER MARKERS

Selection Guide

Fibers

FT / FD / FR

Fiber Sensor Amplifiers

FX-100

FX-300

FX-410

FX-311

FX-11A

FX-301-F

Other Products

FT-A8

Thru-beam type

Parallel deviation

• Vertical direction

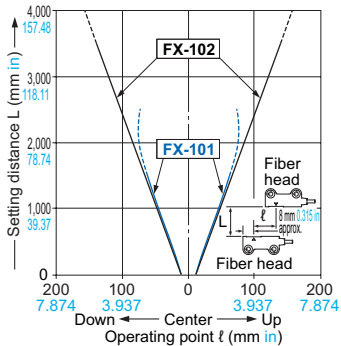

• Horizontal direction

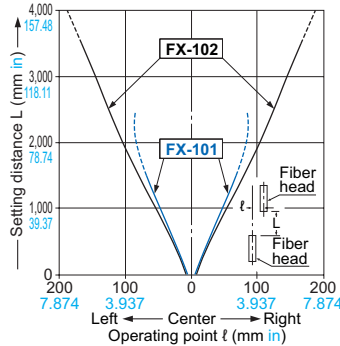

FT-B8

Thru-beam type

Parallel deviation

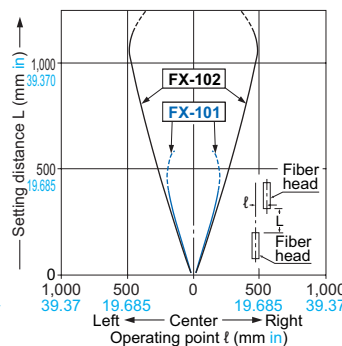

FT-FM2 FT-FM2S FT-FM2S4 FT-SFM2 FT-T80

Thru-beam type

Parallel deviation

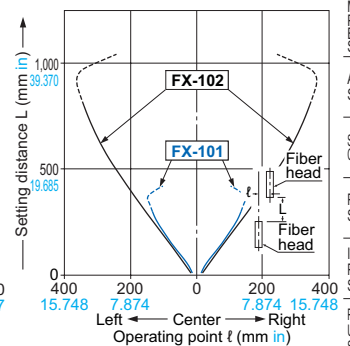

FT-NFM2 FT-NFM2S FT-NFM2S4 FT-SNFM2

Thru-beam type

Parallel deviation

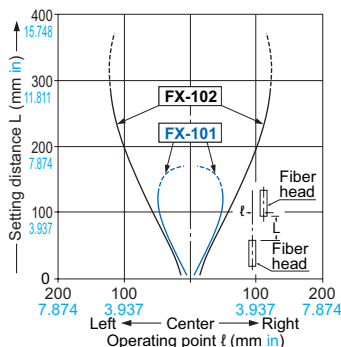

FT-P81X

Thru-beam type

Parallel deviation

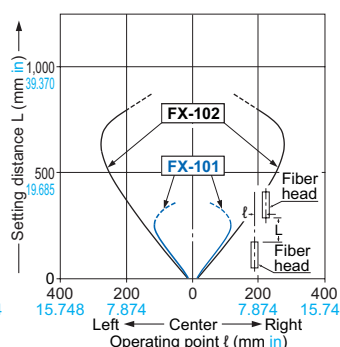

FT-W4 FT-WS4

Thru-beam type

Parallel deviation

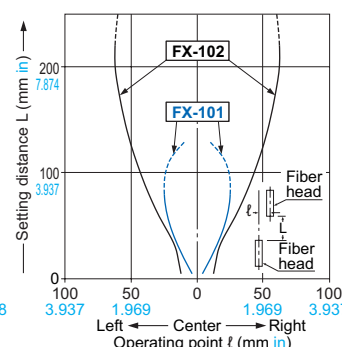

FT-W8 FT-WS8

Thru-beam type

Parallel deviation

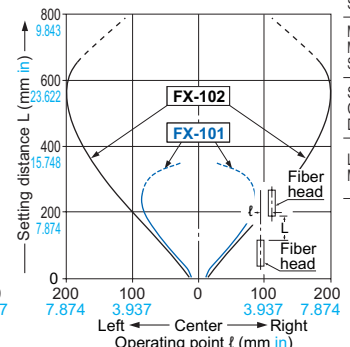

FD-B8

Reflective type

Sensing field

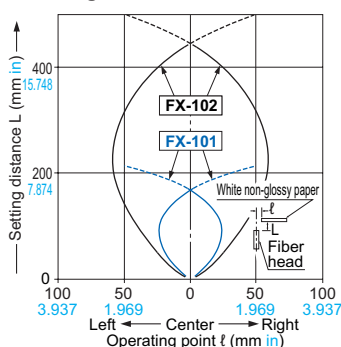

FD-FM2

Reflective type

Sensing field

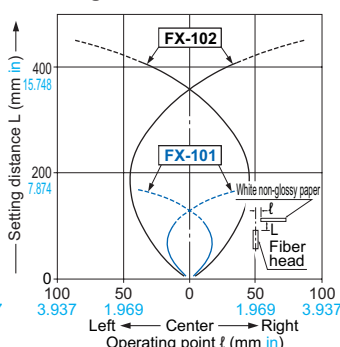

FD-G4

Reflective type

Sensing field

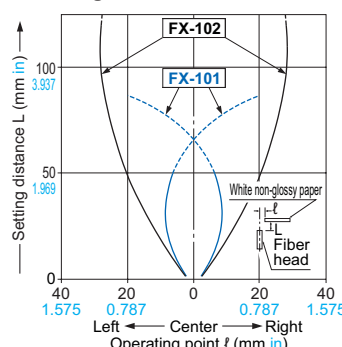

FD-G6X

Reflective type

Sensing field

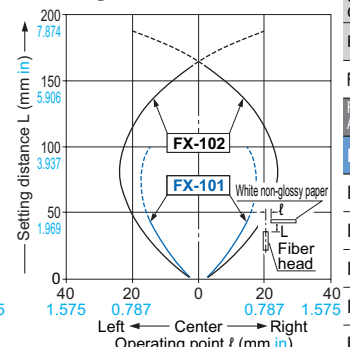

FD-NFM2 FD-NFM2S FD-NFM2S4 FD-SNFM2 FD-T40

Reflective type

Sensing field

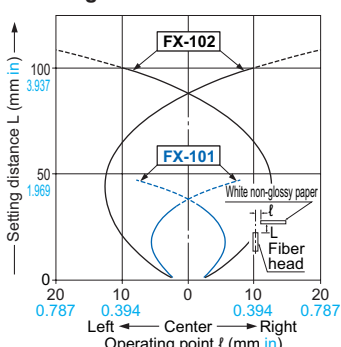

FD-P81X

Reflective type

Sensing field

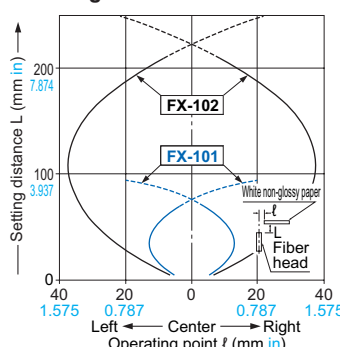

FD-W8 FD-WS8 FD-WT8

Reflective type

Sensing field

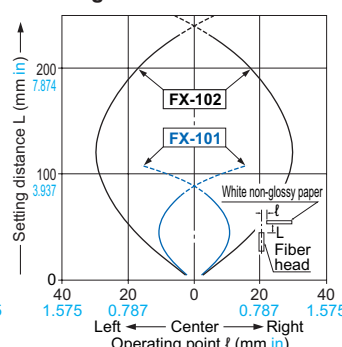

FD-WG4 FD-WSG4

Reflective type

Sensing field

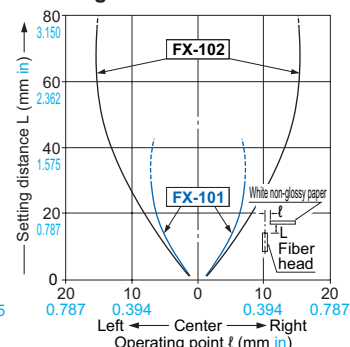

PRECAUTIONS FOR PROPER USE

Refer to p.986~ for general precautions, and to the "Operation Guide" or "SUNX website" (<http://www.sunx.com>) for details pertaining to operating instructions for the amplifier.



- Never use this product as a sensing device for personnel protection.
- In case of using sensing devices for personnel protection, use products which meet laws and standards, such as OSHA, ANSI or IEC etc., for personnel protection applicable in each region or country.

Using in combination with the FX-300 / FX-400 series

- The **FX-100** series does not use the horizontal connectors that are used with the **FX-300 / FX-400** series. Please note that horizontal connection cannot be performed using a connector attached cable. In addition, the optical communication function is not equipped on the **FX-100** series, so it is unable to perform interference prevention for use with the **FX-300 / FX-400** series. If using the **FX-100** series together with the **FX-300 / FX-400** series side-by-side, please set the same models together in groups.

Mounting

<When using a DIN rail>

How to mount the amplifier

- ① Fit the rear part of the mounting section of the amplifier on a 35 mm 1.378 in width DIN rail.
- ② Press down the rear part of the mounting section of the unit on the 35 mm 1.378 in width DIN rail and fit the front part of the mounting section to the DIN rail.

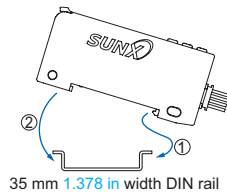

How to remove the amplifier

- ① Push the amplifier forward.
- ② Lift up the front part of the amplifier to remove it.

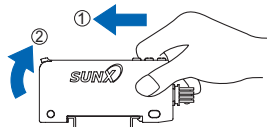

Note: Take care that if the front part is lifted without pushing the amplifier forward, the hook on the rear portion of the mounting section is likely to break.

<When using screws with washers>

- Use M3 screws with washers for mounting. The tightening torque should be 0.5 N·m or less.

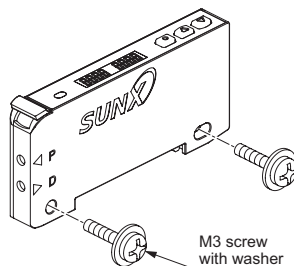

Part description

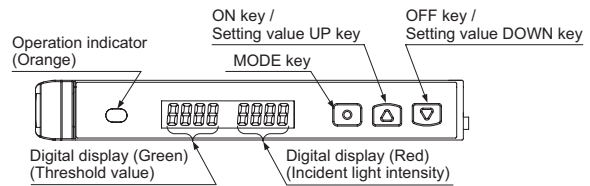

Setting mode

- Setting mode appears after the MODE key is pressed for 2 sec. in RUN mode.







Setting item	Factory setting	Description
Teaching mode	LRch	Threshold value can be set in 2-level teaching, limit teaching, or full-auto teaching.
Output operation setting	l_d d_on [Dark-ON]	Light-ON or Dark-ON can be set.
Timer operation setting	delY non [Without timer]	Without timer, ON delay timer, or OFF delay timer can be set.
Timer setting	ond 10 [ON-delay timer: 10 ms] ofd 10 [OFF-delay timer: 10 ms]	In case of setting ON-delay timer or OFF-delay timer in the timer operation setting mode, timer can be set. When timer is not set, this mode is not displayed.
Emission amount setting	PctL off [OFF]	Setting for reduced intensity of emission amount is possible when the incident light intensity is saturated.
Emission frequency setting	FX-101 FrE9 F-0 [0 (Response time: 250 μs or less)] FX-102 FrE9 F-01 [1 (Response time: 2.5 ms or less)]	In case of using the fiber heads in parallel, interference can be prevented by setting different emission frequency. However, when emission frequency 0 is set, interference cannot be prevented. Response time corresponds to emission frequency. For details, refer to "SPECIFICATIONS" on p.132.

PRECAUTIONS FOR PROPER USE

Refer to p.986~ for general precautions, and to the "Operation Guide" or "SUNX website" (<http://www.sunx.com>) for details pertaining to operating instructions for the amplifier.

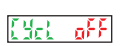
PRO mode

- PRO mode appears after the MODE key is pressed for 4 sec. in RUN mode.

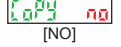
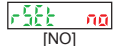
Setting item	Factory setting	Description
Shift setting	 [Shift amount 15 %]	Shift amount can be selected from 0 to 80 % in the limit teaching. Select 0 % when it is desired to set the present incident light intensity as a threshold value.
External input setting	 [Emission halt]	External input can be selected from emission halt, limit +, limit -, AUTO, and ECO.
Threshold value follow-up cycle setting (Note 1)	 [OFF]	When incident light intensity exceeds threshold value, this mode can change the threshold value with each set cycle depending on variations of the incident light intensity. The follow-up shift amount is same as the one set in the shift setting mode. However, the threshold value is not stored.
GETA function setting (Note 2, 3)	 [OFF]	Variations can be reduced by correcting the present incident light intensity in each amplifier to a target value. Target value to offset incident light intensity can be selected from 0 to 2,000 by 100 unit each. For example, if the target value is set to 2,000 when the incident light intensity is 1,500, the incident light intensity becomes 2,000.
ECO setting	 [OFF]	It is possible to light up / turn off the digital display. When ECO setting mode is ON, the display turns off in 20 sec. approx. in RUN mode. To light up the display again, press any key for 2 sec. or more.
Digital display inversion setting	 [OFF]	Digital display can be inverted.
Threshold value margin setting	 [OFF]	Margin for threshold value to the present incident light intensity can be checked. When there is no margin, it is possible to make the digital display blink. OFF : Set to "OFF": does not function. GrEn : Green blinks. rEd : Red blinks. RlL : Red and green blink.
Setting copy	 [NO]	The settings of the master side amplifier can be copied to the slave side amplifier. For details, refer to "Setting copy function."
Reset	 [NO]	Returns to default settings (factory settings.)

- Notes: 1) If the incident light intensity becomes "300" or less, the follow-up operation stops. In that condition, threshold value [digital display (green)] blinks.
This function can be used when thru-beam type or retroreflective type fiber is applied to this product. If reflective type fiber is applied, the function cannot be used depending on use conditions.
- 2) If MODE key is pressed in RUN mode when GETA function is used, the incident light intensity before setting GETA function is displayed on the red digital display for 2 sec. approx.
- 3) When GETA function is used in saturation of incident light intensity (4,000 or more,) "HrEd" is indicated on the red digital display. Correction value is up to 4,000.

Setting copy function

- This can copy the settings of the master side amplifier to the slave side amplifier.

- Be sure to use the setting copy function between the identical models (Between FX-10□ models or FX-102□ models). This function cannot be used between different models.
- Only one sensor can be connected on slave side with a master side sensor for the setting copy function.
- Threshold value, output operation setting, timer operation setting, timer setting, light-emitting amount setting, shift setting, ECO setting, digital display inversion setting, and threshold value margin setting can be copied.

<Setting procedures>

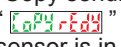
- ① Set the setting copy mode of the master side amplifier to "Copy sending ON", and press the MODE key so that "" is shown on the digital display and the sensor is in copy ready state. For the setting method, refer to "Operation guide".
- ② Turn off the master side amplifier.
- ③ Connect the master side amplifier with the slave side amplifier as shown below.

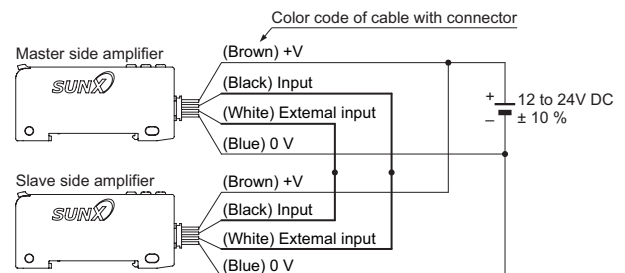

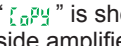
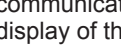
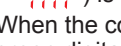
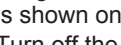
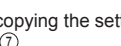
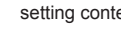
- ④ Turn on the master side amplifier and the slave side amplifier at the same time. (Note)
- ⑤ "" is shown on the green digital display of the master side amplifier and 4-digit code is shown on the red digital display of it, then the copying starts. During copy communication, "" is shown on the green digital display of the slave side amplifier, and the ongoing copy communication indicator ("" → "" → "") is displayed on the red digital display.
- ⑥ When the copying is completed, "" is shown on the green digital display of the slave side amplifier, while the 4-digit code (the same code as the master side amplifier) is shown on the red digital display of it.
- ⑦ Turn off the power of the master side amplifier and the slave side amplifier and disconnect the wire.

* If copying the settings to another amplifier repeatedly, follow the steps ③ to ⑦.

Note: Take care that if the power is not turned on at the same time, the setting contents may not be copied.

<To cancel the setting copy mode of the master side amplifier>

- ① While the slave side amplifier is disconnected, turn on the power of the master side amplifier.
- ② Press the MODE key for 2 sec. approx.

FIBER SENSORS

LASER SENSORS

PHOTO-ELECTRIC SENSORS

MICRO PHOTO-ELECTRIC SENSORS

AREA SENSORS

SAFETY COMPONENTS

PRESSURE SENSORS

INDUCTIVE PROXIMITY SENSORS

PARTICULAR USE SENSORS

SENSOR OPTIONS

WIRE-SAVING SYSTEMS

MEASUREMENT SENSORS

STATIC CONTROL DEVICES

LASER MARKERS

Selection Guide

Fibers

FT / FD / FR

Fiber Sensor Amplifiers

FX-100**FX-300****FX-410****FX-311****FX-11A****FX-301-F**

Other Products

FIBER SENSORS

LASER SENSORS

PHOTO-ELECTRIC SENSORS

MICRO PHOTO-ELECTRIC SENSORS

AREA SENSORS

SAFETY COMPONENTS

PRESSURE SENSORS

INDUCTIVE PROXIMITY SENSORS

PARTICULAR USE SENSORS

SENSOR OPTIONS

WIRE-SAVING SYSTEMS

MEASUREMENT SENSORS

STATIC CONTROL DEVICES

LASER MARKERS

Selection Guide

Fibers

FT / FD / FR

Fiber sensor Amplifiers

FX-100

FX-300

FX-410

FX-311

FX-11A

FX-301-F

Other Products

PRECAUTIONS FOR PROPER USE

Refer to p.986~ for general precautions, and to the "Operation Guide" or "SUNX website" (<http://www.sunx.com>) for details pertaining to operating instructions for the amplifier.

Quick setting function

- Settings for "output operation", "light-emitting amount", "timer", and "emission frequency" are possible simply by selecting a setting number.
- The quick setting function makes it possible to set the content of the SET Mode (output operation, timer operation, amount of light emitted, and frequency of light emitted) simply by selecting a setting number.
- While in the RUN Mode, pressing and holding both the ON key (ON) and OFF key (OFF) simultaneously for 2 seconds will switch to the quick setting function.

<Table of quick setting numbers>

No.	Output operation	Emission amount setting	Timer
-00-	D-ON	OFF	non
-01-	D-ON	ON	non
-02-	D-ON	OFF	ofd 10 ms
-03-	D-ON	ON	ofd 10 ms
-04-	D-ON	OFF	ofd 40 ms
-05-	D-ON	ON	ofd 40 ms
-06-	D-ON	OFF	ond 10 ms
-07-	D-ON	ON	ond 10 ms
-08-	D-ON	OFF	ond 40 ms
-09-	D-ON	ON	ond 40 ms
-10-	L-ON	ON	ond 40 ms
-11-	L-ON	OFF	ond 40 ms
-12-	L-ON	ON	ond 10 ms
-13-	L-ON	OFF	ond 10 ms
-14-	L-ON	ON	ofd 40 ms
-15-	L-ON	OFF	ofd 40 ms
-16-	L-ON	ON	ofd 10 ms
-17-	L-ON	OFF	ofd 10 ms
-18-	L-ON	ON	non
-19-	L-ON	OFF	non

Code setting function

- Settings for "output operation", "timer", "emission amount", "emission frequency", "ECO", "external input", and "shift amount" are possible by selecting codes discretionary.
- The code setting function makes it possible to set the output operation, timer operation, amount of light emitted, frequency of light emitted, ECO setting, external input, and amount of shift by selecting a code of one's choice.
- While in the RUN Mode, pressing and holding both the ON key (ON) and OFF key (OFF) simultaneously for 4 seconds will switch to the code setting function.

<Code table>

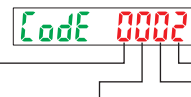

Code	1st digit		2nd digit		3rd digit		4th digit	
	Output operation	Timer (Note5)	Emission amount setting	Emission Frequency FX-101□ FX-102□	ECO	External input	Shift (Note5)	
0	D-on	non	OFF	0	OFF	E_oF	5 %	
1		ond 10 ms		1		2	Limit [+]	10 %
2		ond 40 ms		2		3	Limit [-]	15 %
3		ofd 10 ms		3		4	Auto	20 %
4	L-on	ofd 40 ms	ON	0	ON	Eco	25 %	
5		non		1		2	E_oF	30 %
6		ond 10 ms		2		3	Limit [+]	35 %
7		ond 40 ms		3		4	Limit [-]	40 %
8		ofd 10 ms					Auto	45 %
9	ofd 40 ms	Eco	50 %					

Notes: 1) When the present setting is out of the code setting range, "-" is shown.
When "-" is selected, the set content of the digit is not changed.
2) The factory setting is "0002".

Others

- Do not use during the initial transient time (0.5 sec.) after the power supply is switched on.
- EEPROM is adopted to this product. It is not possible to conduct teaching 100 thousand times or more, because of the EEPROM's lifetime.

DIMENSIONS (Unit: mm in)

Refer to p.106~ for fiber dimensions. The CAD data in the dimensions can be downloaded from the website: <http://www.sunx.com>

FX-101 □ FX-102 □ Amplifier

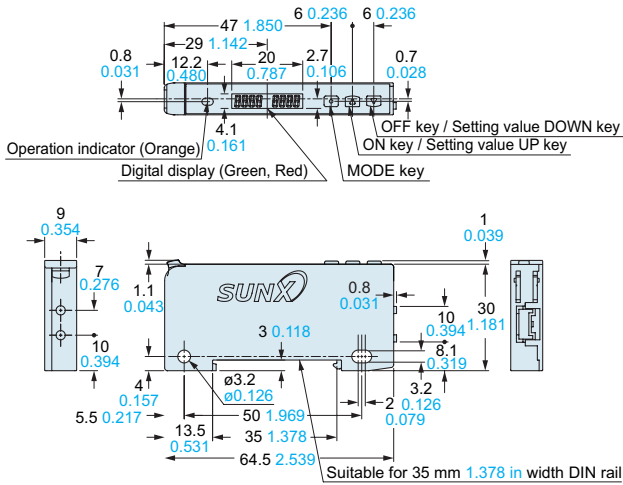

FX-101(P)-Z FX-102(P)-Z Amplifier

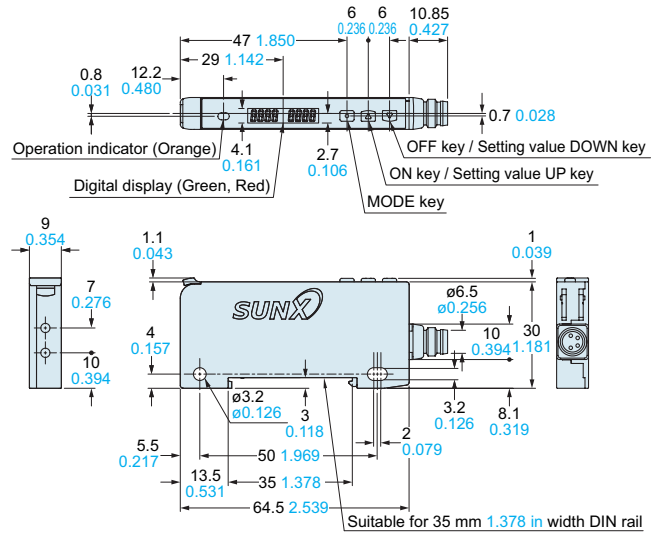

Assembly dimensions with optional protective cover (FC-FX-1)

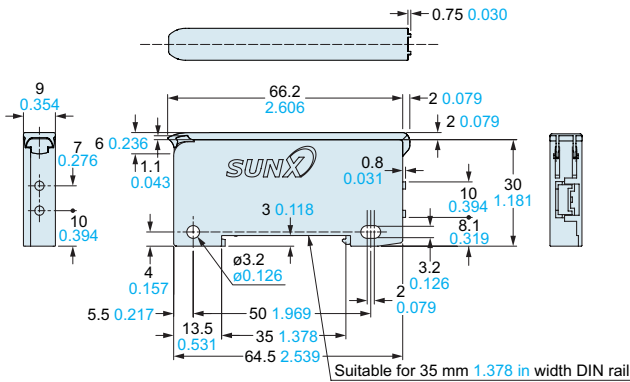

MS-DIN-4 Amplifier mounting bracket (Optional)

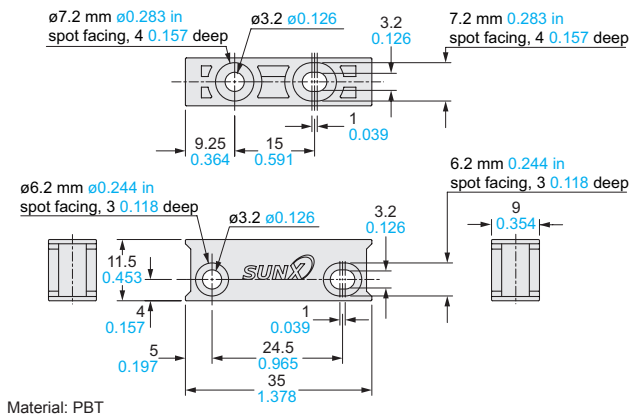

MS-DIN-E End plate (Optional)

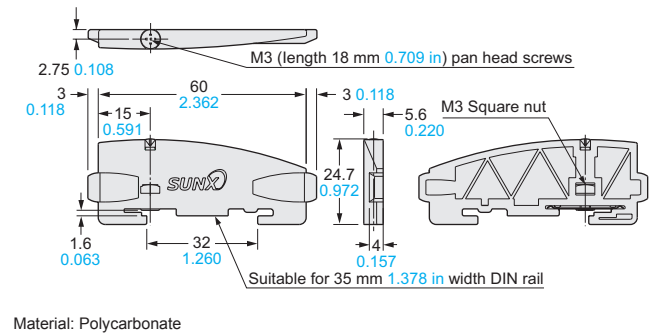

CN-14A-C □ CN-14A-R-C □ Connector attached cable (Optional)

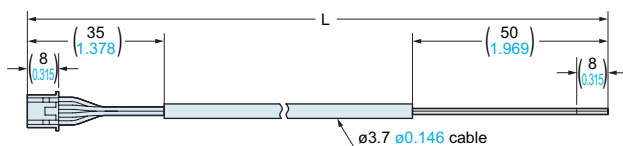

CN-14A-C2 is attached FX-101(P)-CC2 / FX-102(P)-CC2

• Length L

Model No.	Length L
CN-14A(-R)-C1	1,000 39.370
CN-14A(-R)-C2	2,000 78.740
CN-14A(-R)-C3	3,000 118.110
CN-14A(-R)-C5	5,000 196.850

FIBER SENSORS

LASER SENSORS

PHOTO-ELECTRIC SENSORS

MICRO PHOTO-ELECTRIC SENSORS

AREA SENSORS

SAFETY COMPONENTS

PRESSURE SENSORS

INDUCTIVE PROXIMITY SENSORS

PARTICULAR USE SENSORS

SENSOR OPTIONS

WIRE- SAVING SYSTEMS

MEASURE- MENT SENSORS

STATIC CONTROL DEVICES

LASER MARKERS

Selection Guide

Fibers

FT / FD / FR

Fiber Sensor Amplifiers

FX-100

FX-300

FX-410

FX-311

FX-11A

FX-301-F

Other Products