



# EVERLIGHT ELECTRONICS CO.,LTD.

PART NO : 30-01SUGC Device Number : DLE-300-006 REV: 1.3  
 ECN : \_\_\_\_\_ Page: 1/4

## Benefits :

- Fewer LEDs Required
- Lowers Lighting System Cost

## Features :

- High Flux Output.
- Designed for High Current Operation.
- Low Thermal Resistance.
- Low Profile.
- Packaged in Tubes for Use with Automatic Insertion Equipment.



## Applications :

- Automotive Exterior Lighting
- Electronic Signs and Signals

## Descriptions :

This revolutionary package design allows the lighting designer to reduce the number of LEDs required and provide a more uniform and unique illuminated appearance than with other LED solutions. This is possible through the efficient optical package design and high-current capabilities. The low profile package can be easily coupled with reflectors or lenses to efficiently distribute light and provide the desired lit appearance.

This product family employs the world's brightest red-orange and amber LED materials, which allow designers to match the color of popular lighting applications, such as automotive tail, stop, and turn signal lamps, and electronic signs.

PART NO	Chip		Lens Color
	Material	Emitted Color	
30-01SUGC	GaN	Super Green	Water Clear

OFFICE : NO. 25, Lane 76, Sec.3, Chung Yang Rd., Tucheng 236, Taipei, Taiwan, R.O.C.  
 TEL : 886-2-2267-2000, 2267-9936  
 FAX : 886-2-2267-6244, 22676189, 22676306  
<http://www.everlight.com>



# EVERLIGHT ELECTRONICS CO.,LTD.

Device Number : DLE-300-006 REV: 1.3  
PART NO : 30-01SUGC ECN : \_\_\_\_\_ Page: 2/4

## ■ Absolute Maximum Ratings at $T_a = 25^\circ\text{C}$

Parameter	Symbol	Rating	Unit
Forward Current	$I_F$	30	mA
Operating Temperature	$T_{opr}$	-20 to +80	$^\circ\text{C}$
Storage Temperature	$T_{opr}$	-30 to +100	$^\circ\text{C}$
Soldering Temperature	$T_{sol}$	$260 \pm 5$	$^\circ\text{C}$
Electrostatic Discharge	ESD	150	V
Power Dissipation	$P_d$	120	mW
Peak Forward Current(Duty 1/10 @ 1KHz)	$I_F(\text{Peak})$	100	mA
Reverse Voltage	$V_R$	5	V

## ■ Package Dimensions:

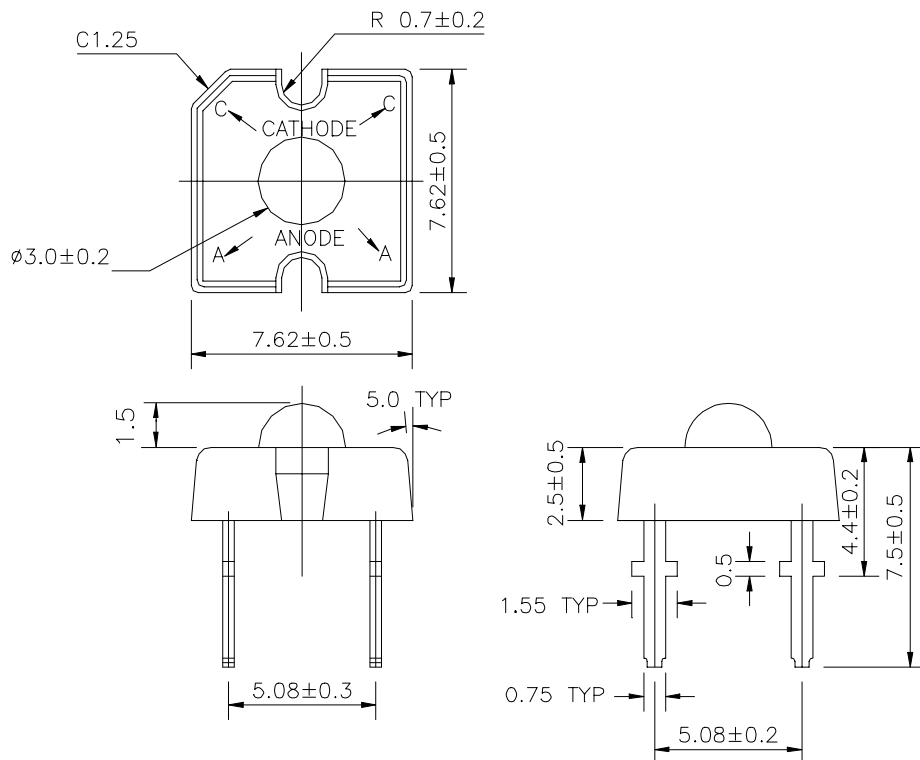

### Notes :

- 1.All dimensions are millimeter.(inch)
- 2.An epoxy meniscus may extend about 1.5mm(0.059") down the lead.



# EVERLIGHT ELECTRONICS CO.,LTD.

Device Number : DLE-300-006 REV: 1.3  
 PART NO : 30-01SUGC ECN : \_\_\_\_\_ Page: 3/4

## ■ Electro-Optical Characteristics :

Parameter	Symbol	Min.	Typ.	Max.	Condition	Unit
Total Flux	$\Phi_v$	250	400	----	IF=20mA	mlm
Viewing Angle	$2\theta_{1/2}$	----	60	----	IF=20mA	deg
Peak Wavelength	$\lambda_p$	----	525	----	IF=20mA	nm
Dominant Wavelength	$\lambda_d$	----	530	----	IF=20mA	nm
Spectrum Radiation Bandwidth	$\Delta\lambda$	----	35	----	IF=20mA	nm
Forward Voltage	V <sub>F</sub>	----	3.5	4.3	IF=20mA	V
Reverse Current	I <sub>R</sub>	----	----	50	V <sub>R</sub> =5V	$\mu A$
Recommended Operating Current	I <sub>F</sub> (Rec)	----	----	20		mA
DC Forward Current	I <sub>F</sub> (mA)	----	----	30		mA

## ■ Reliability test items and conditions

NO	Item	Test Conditions	Test Hours/Cycle	Sample Size	Ac/Re
1	Solder Heat	TEMP:260°C ± 5 °C	5 SEC	76 PCS	0/1
2	Temperature Cycle	H : +85°C 30min ∫ 5 min L : -55°C 30min	50 CYCLES	76 PCS	0/1
3	Thermal Shock	H : +100°C 5min ∫ 10 sec L : -10°C 5min	50 CYCLES	76 PCS	0/1
4	High Temperature Storage	TEMP : 100°C	1000 HRS	76 PCS	0/1
5	Low Temperature Storage	TEMP : -55°C	1000 HRS	76 PCS	0/1
6	DC Operating Life	I <sub>F</sub> (max) mA	1000 HRS	76 PCS	0/1
7	High Temperature / High Humidity	85°C/85% RH	1000 HRS	76 PCS	0/1



PART NO : 30-01SUGC Device Number : DLE-300-006 REV: 1.3  
 ECN :                      Page: 4/4

■ Typical Electro-Optical Characteristic Curves

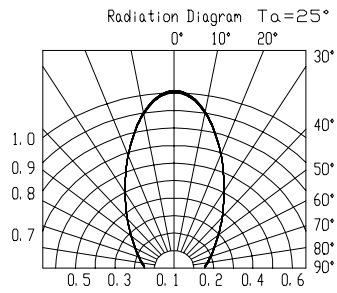
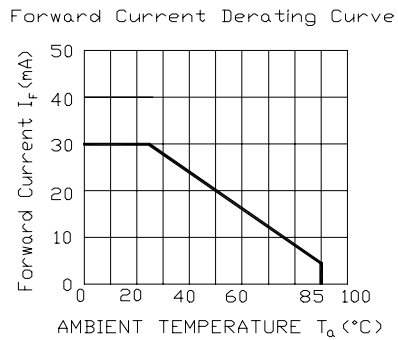
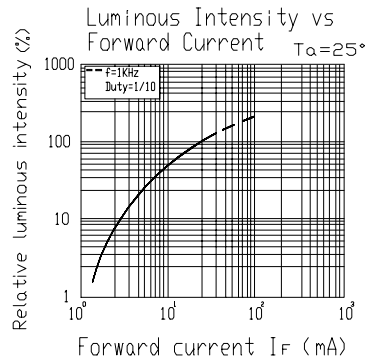
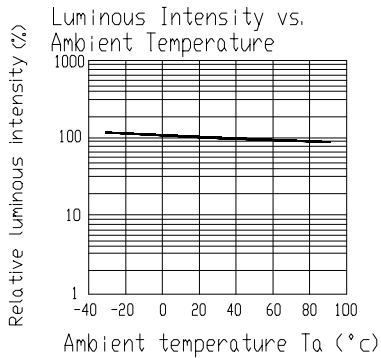
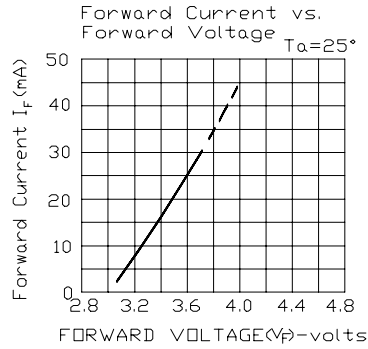
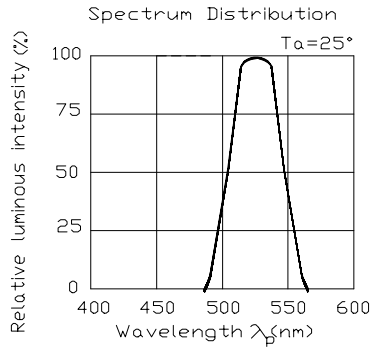

■ Specifications for Bin Grading

30-01SUGC-     
 ①                    ②                    ③

①	VF(v)		②	λ d(nm)		③	Φv(mlm)	
Bin	Min	Max	Bin	Min	Max	Bin	Min	Max
1	3.0	3.2	0	520	526	T	250	500
2	3.2	3.4	1	525	531	U	400	800
3	3.4	3.6	2	530	536	V	630	1250
4	3.6	3.8	3	535	540	W	1000	2000
5	3.8	4.3						