



ACCESSORIES

CONTENTS	PAGE
Cable Terminators	403
Taper Sleeves	406
Coloured Plastic Caps	407
Fastening Screws	407
Insulating Washers	408
Solder Tags	409
Component Container "SUCOBOX"	410
Accessories for SK Connectors	411
Accessories for BMA Connectors	411
HUBER+SUHNER QUICK-FIT® Accessories	411

CABLE TERMINATORS

Straight PCB cable terminators

- > for flexible cables
- > cable entry crimp
- > 5.08 mm / .200 in. grid

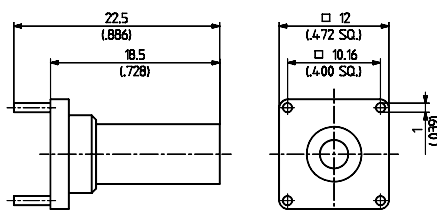

H+S type	Item no.	Cable group (example)	Packaging	Plating body	Assembly Instruction/ Mounting Hole	Crimp insert
83_CT-0-3-1/-23_E	23013153	U7 (RG 58 C/U)	single	nickel	27407 / ML 49	B
83_CT-0-3-2/-23_E	23013154	U9 (RG 223/U)	single	nickel	27407 / ML 49	B

> for flexible cables

- > cable entry crimp
- > 2.54 mm / .100 in. grid

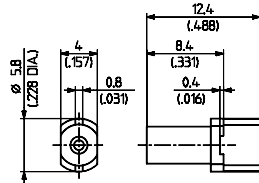

H+S type	Item no.	Cable group (example)	Packaging	Plating body	Assembly Instruction/ Mounting Hole	Crimp insert
83_CT-0-1-1/-11_NE	23013158	U1 (RG 178 B/U)	single	gold	27408 / ML 45	A
83_CT-0-2-1/-11_NE	23013159	U2 (RG 316/U)	single	gold	27408 / ML 45	A
83_CT-0-2-1/-11_NH	23013160	U2 (RG 316/U)	bulk 100 pcs.	gold	27408 / ML 45	A
83_CT-0-2-2/-11_NE	23013161	U4 (K 02252 D)	single	gold	27408 / ML 45	A

> for semi-rigid cables

- > cable entry soldered
- > 2.54 mm / .100 in. grid

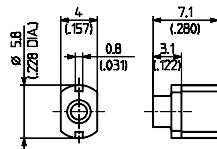
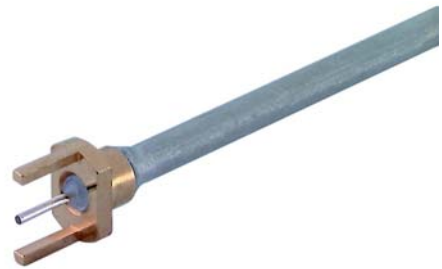

H+S type	Item no.	Cable group (example)	Packaging	Plating body	Assembly instruction/ Mounting hole
83_CT-0-2-4/-11_NE	23013176	Y3, Y11 (EZ 86)	single	gold	27410 / ML 45
83_CT-0-2-4/-11_NH	23013177	Y3, Y11 (EZ 86)	bulk 100 pcs.	gold	27410 / ML 45

> for flexible cables

- > cable entry crimp
- > 2.54 mm / .100 in. grid

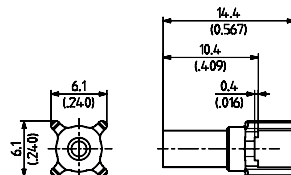
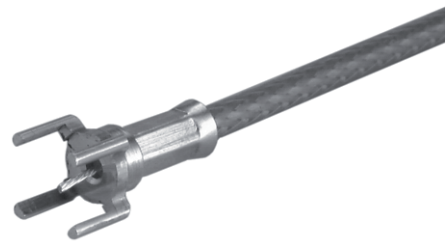

H+S type	Item no.	Cable group (example)	Packaging	Plating body	Assembly Instruction/ Mounting Hole	Crimp insert
83_CT-0-2-3/-11_NE	23013192	U2 (RG 316/U)	single	gold	27409 / ML 15	A

TAPER SLEEVES AND SUITABLE ASSEMBLY TOOLS

Release spray is recommended for mounting (Acmos 70 - 2404, oil-less)

- > for connectors with cable entry crimp
- > made of EVA (ethylenevinylacetat)
- > temperature resistant - 40°C – + 70°C / - 40 °F + 158 °F
- > halogen free
- > can be recycled



Cable group	U1	U2, U5, S5	U4, R8	U7, U8, U11, U12, U13 + RG142 B/U, EF 142		U16*, U17	
example	RG 196 A/U	RG 188 A/U RG 179 B/U	G 02232 D K 02252 D	RG 58 C/U	RG 223/U G 03233 D	RG 59 B/U	G 04233 D
colour black	78_Z-0-1-1	78_Z-0-2-1	78_Z-0-2-3	78_Z-0-3-4	78_Z-0-3-5	78_Z-0-4-4	78_Z-0-4-5
Item no.	22544447	22544467	22544457	22544408	22641890	22544427	22641673
brown	78_Z-1-1-1	78_Z-1-2-1	78_Z-1-2-3	78_Z-1-3-4	78_Z-1-3-5	78_Z-1-4-4	78_Z-1-4-5
Item no.	22544448	22544468	22544458	22544416	22641664	22544436	22641674
red	78_Z-2-1-1	78_Z-2-2-1	78_Z-2-2-3	78_Z-2-3-4	78_Z-2-3-5	78_Z-2-4-4	78_Z-2-4-5
Item no.	22544449	22544469	22544459	22544415	22641665	22544435	22641675
orange	78_Z-3-1-1	78_Z-3-2-1	78_Z-3-2-3	78_Z-3-3-4	78_Z-3-3-5	78_Z-3-4-4	78_Z-3-4-5
Item no.	22544450	22544470	22544460	22544414	22641666	22544434	22641676
yellow	78_Z-4-1-1	78_Z-4-2-1	78_Z-4-2-3	78_Z-4-3-4	78_Z-4-3-5	78_Z-4-4-4	78_Z-4-4-5
Item no.	22544451	22544471	22544461	22544413	22641667	22544433	22641677
green	78_Z-5-1-1	78_Z-5-2-1	78_Z-5-2-3	78_Z-5-3-4	78_Z-5-3-5	78_Z-5-4-4	78_Z-5-4-5
Item no.	22544452	22544472	22544462	22544412	22641668	22544432	22641678
blue	78_Z-6-1-1	78_Z-6-2-1	78_Z-6-2-3	78_Z-6-3-4	78_Z-6-3-5	78_Z-6-4-4	78_Z-6-4-5
Item no.	22544453	22544473	22544463	22544411	22641669	22544431	22641679
violet	78_Z-7-1-1	78_Z-7-2-1	78_Z-7-2-3	78_Z-7-3-4	78_Z-7-3-5	78_Z-7-4-4	78_Z-7-4-5
Item no.	22544454	22544474	22544464	22544410	22641670	22544430	22641680
grey	78_Z-8-1-1	78_Z-8-2-1	78_Z-8-2-3	78_Z-8-3-4	78_Z-8-3-5	78_Z-8-4-4	78_Z-8-4-5
Item no.	22544455	22544475	22544465	22544409	22641671	22544429	22641681
white	78_Z-9-1-1	78_Z-9-2-1	78_Z-9-2-3	78_Z-9-3-4	78_Z-9-3-5	78_Z-9-4-4	78_Z-9-4-5
Item no.	22544456	22544476	22544466	22544508	22641672	22544428	22641682
length	20 mm/.79 in.	20 mm/.79 in.	20 mm/.79 in.	38 mm/1.5 in.	38 mm/1.5 in.	38 mm/1.5 in.	38 mm/1.5 in.
Assembly Tool	74_Z-0-2-1	74_Z-0-2-1	74_Z-0-2-1	74_Z-0-3-6	74_Z-0-3-6	74_Z-0-4-6	74_Z-0-4-6
Item no.	22543144	22543144	22543144	22544544	22544544	22544543	22544543

* without RG 302

The two types below are available in black only

Cable group	U29, U30, U34	U32, U36
example	RG 213/U	RG 214/U
colour black	78_Z-0-7-1	78_Z-0-7-2
Item no.	22641162	22641163
length	48 mm / 1.89 in.	48 mm / 1.89 in.
Assembly tool	74_Z-0-7-2	74_Z-0-7-3
Item no.	22641165	22641164



COLOURED PLASTIC CAPS

H+S type	Item no.	Packaging	Colour
61_BNC-0-0-7 / -_H	22543863	bulk 100 pcs.	black
61_BNC-1-0-7 / -_H	22543864	bulk 100 pcs.	brown
61_BNC-2-0-7 / -_H	22543865	bulk 100 pcs.	red
61_BNC-3-0-7 / -_H	22543866	bulk 100 pcs.	orange
61_BNC-4-0-7 / -_H	22543867	bulk 100 pcs.	yellow
61_BNC-5-0-7 / -_H	22543868	bulk 100 pcs.	green
61_BNC-6-0-7 / -_H	22543869	bulk 100 pcs.	blue
61_BNC-7-0-7 / -_H	22543870	bulk 100 pcs.	violet
61_BNC-8-0-7 / -_H	22543871	bulk 100 pcs.	grey
61_BNC-9-0-7 / -_H	22543872	bulk 100 pcs.	white



Suitable for all HUBER+SUHNER® BNC plugs (can be pressed on to collar in front of coupling nut)

FASTENING SCREWS

for panel receptacles (pattern 13, 15, 23, 25)

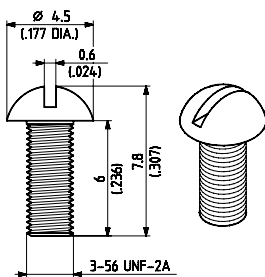

Fig. 1

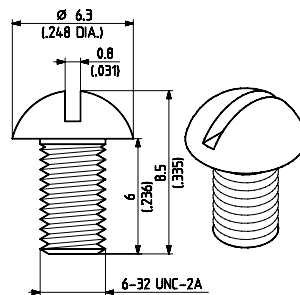

Fig. 2

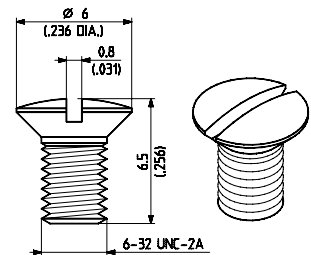
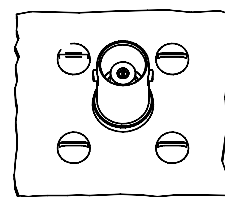

Fig. 3

H+S type	Item no.	Packaging	Thread	Fig.
73_Z-0-0-2 / -_3H	22543044	bulk 100 pcs.	3-56 UNF	1
73_Z-0-0-6 / -_0H	22543050	bulk 100 pcs.	6-32 UNC	2
73_Z-0-0-7 / -_3H	22543052	bulk 100 pcs.	6-32 UNC	3



INSULATING WASHERS

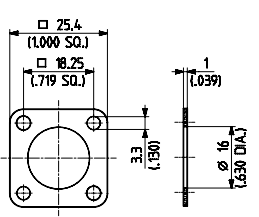

Fig. 1

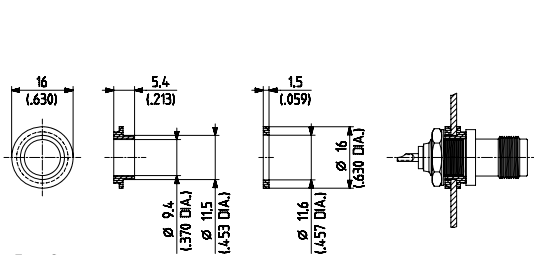

Fig. 2

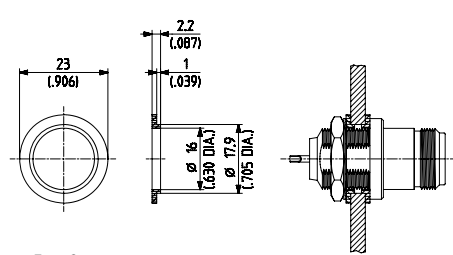

Fig. 3

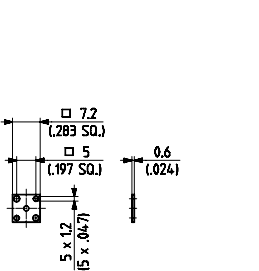

Fig. 4

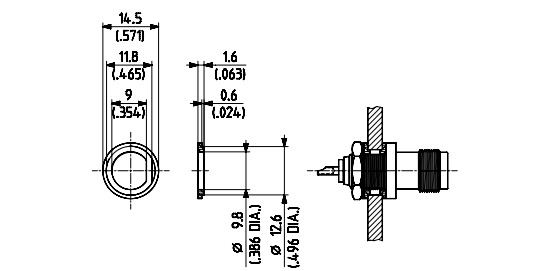

Fig. 5

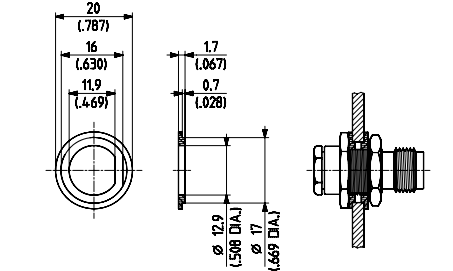

Fig. 6

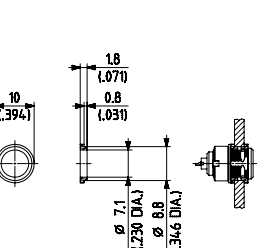

Fig. 7

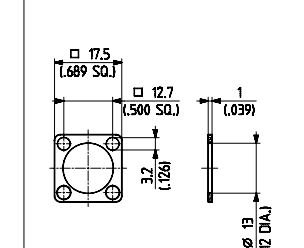

Fig. 8

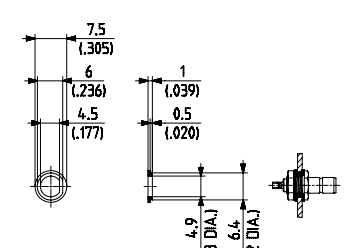

Fig. 9

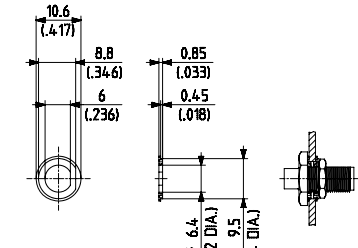

Fig. 10

H+S type	Item no.	Suitable for:		Mounting hole	Material	Fig.	Notes
		Connector pattern *	Connector series				
77_Z-0-0-1/-_H	22543199	23, 25	N	ML 14	polyamide	1	10 pcs each
77_Z-0-0-2/-_H	22543200	12, 22	BNC, TNC	ML 102	polyamide	2	**/10 pairs
77_Z-0-0-4/-_Z	22543202	12,22,24,34	N	ML 113	polyamide	3	10 pairs
77_Z-0-0-8/-_H	22543204	82, 85	SMB/C/S, MCX, QLA 00, SMA	ML 41	PTFE	4	100 pcs
77_Z-0-0-9/-_Z	22543205	12, 22	BNC, TNC	ML 4	polycarbonate	5	**/10 pairs
77_Z-0-0-12/-_H	22543209	24, 34	BNC, TNC	ML 22	polycarbonate	6	10 pairs
77_Z-0-0-14/-_Z	22543211	22, 24, 34	QLA 00	ML 114	polyamide	7	**/10 pairs
77_Z-0-0-15/-_H	22641429	23, 25	BNC, TNC	ML 8	polyethylene	8	10 pcs each
77_Z-0-0-21/-_Z	22645782	22, 24, 34	SMB/C/S	ML 35	polycarbonate	9	10 pairs
77_Z-0-0-23/-_Z	22652083	22, 34***	SMA	ML 2	polycarbonate	10	for connectors with ML 35 only / 10 pairs

* see connector pattern on page 5

** without rotation protection

*** not all types of pattern 34 are suitable for insulated mounting

SOLDER TAGS

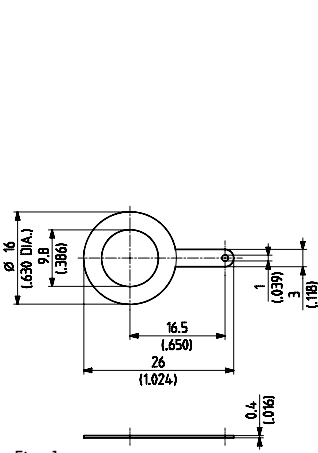

Fig. 1

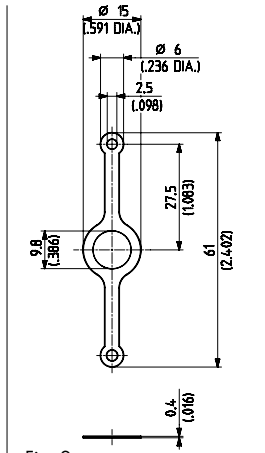

Fig. 2

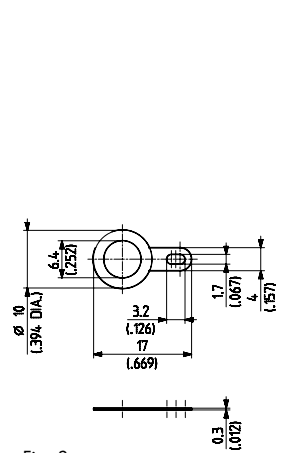

Fig. 3

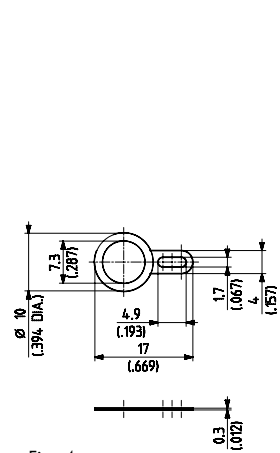

Fig. 4

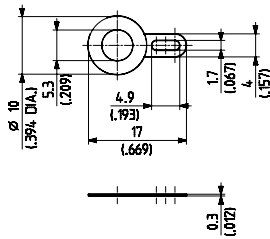

Fig. 5

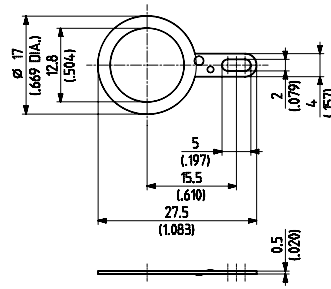

Fig. 6

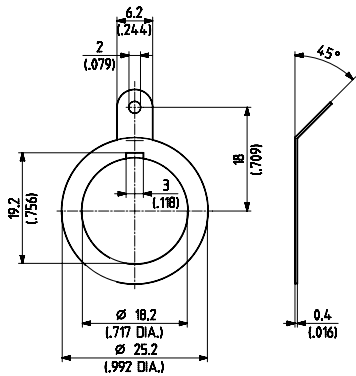

Fig. 7

H+S type	Item no.	Connector pattern*	Suitable for:		Packaging	Fig.	Notes
			Connector series				
72_Z-0-0-1/-_5H	22543029	12, 22	BNC, BNO, BNT, SHV, MHV, TNC		bulk 100 pcs.	1	single ended
72_Z-0-0-2/-_H	22543033	12, 22	BNC, BNO, BNT, SHV, MHV, TNC		bulk 100 pcs.	2	double ended
72_Z-0-0-6/-_0H	22543036	22, 24, 34	SMA		bulk 100 pcs.	3	single ended
72_Z-0-0-8/-_5H	22543038	22, 24	QLA 00		bulk 100 pcs.	4	single ended
72_Z-0-0-9/-_5H	22543039	12, 22, 24, 34	SMB/SMC/SMS, MCX		bulk 100 pcs.	5	single ended
72_Z-0-0-11/-_5H	22641496	24, 34	BNC, BNO, BNT, SHV, MHV, TNC		bulk 100 pcs.	6	single ended
72_Z-0-0-13/-_5H	22642507	22, 24, 34	N		bulk 100 pcs.	7	single ended

* see connector pattern on page 5

COMPONENT CONTAINER "SUCOBOX"

The HUBER+SUHNER "SUCOBOX" is a versatile component container with coaxial input and output connectors or cable entries.

SUCOBOX I

The basic element consists of two similar container parts, two soldering plates for easy soldering of the earthing and 8 tightening screws.

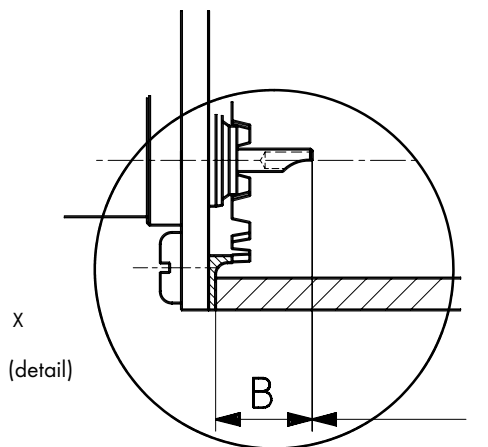

B = distance between pin end and soldering plate

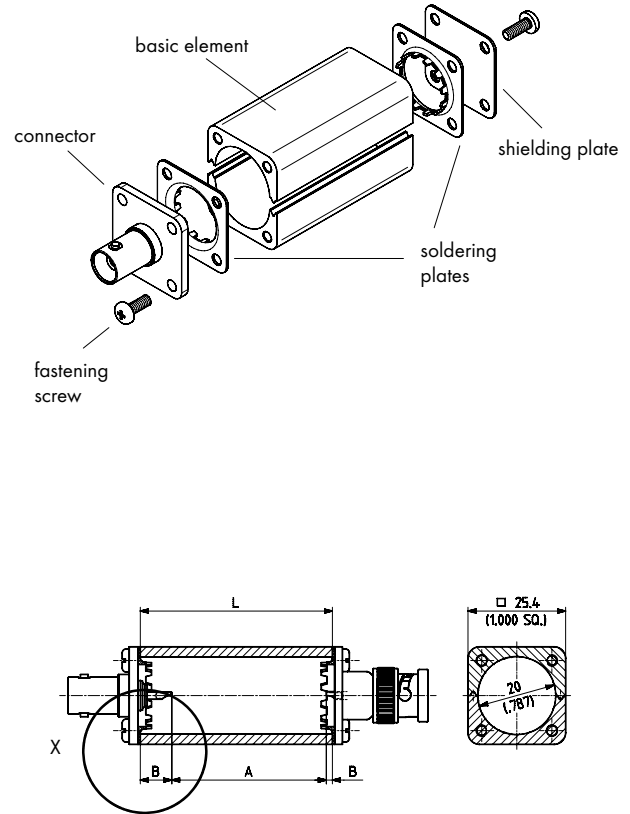

H+S type	Item no.	Description	Length L	Material	Packaging
66_CB-35-0-1/--_E	22541510	basic element	35.0 mm / 1.38 in.	aluminium, anodized, blue	single
66_CB-50-0-1/--_E	22541514	basic element	50.0 mm / 1.97 in.	aluminium, anodized, blue	single
72_Z-0-0-5/--_OH	22543035	soldering plate, separate	–	brass, silver plated	bulk 100 pcs.
73_Z-0-0-9/--_H	22543056	shielding plate, separate	–	brass, silver plated	bulk 100 pcs.

Suitable connectors

H+S type	Item no.	Connector	Dimension B (see drawing top left)	Packaging
13_BNC-50-0-2/133_NE	22540160	plug	1.5 mm / 0.06 in.	single
23_BNC-50-0-2/133_NE	22540333	jack	8.0 mm / 0.31 in.	single
13_N-50-0-1/133_NE	22542173	plug	9.0 mm / 0.35 in.	single
23_N-50-0-1/133_NE	22542272	jack	9.0 mm / 0.35 in.	single

ACCESSORIES FOR SK CONNECTORS

Glass bead for 12 SK, 13 SK, 22 SK, 23 SK
connectors (package with 1 piece)

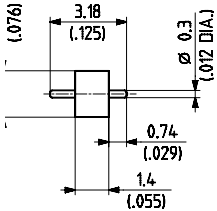

HUBER+SUHNER® TYPE
73_Z-0-0-203
Item no. 22645983

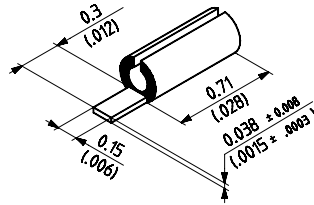

Microstrip stress relief contacts
(package with 100 pieces)

HUBER+SUHNER® TYPE
73_Z-0-0-204
Item no. 22645980
Mounting instruction 9183

ACCESSORIES FOR BMA CONNECTORS

Glass bead for 12_BMA-50-0-3
and 22_BMA-50-0-3

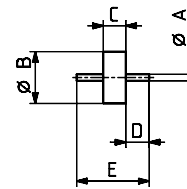

H+S type	Item no.	Ø A	Ø B	C	D	E
73_Z-0-0-198	22645655	0.5 mm / .020 in.	4.0 mm / .157 in.	1.75 mm / .069 in.	1.8 mm / .071 in.	5.6 mm / .220 in.

ACCESSORIES FOR HUBER+SUHNER QUICK-FIT®

Cold shrink tubes for additional protection



H+S type	Item no.	Packaging	Application of connector pair
73_Z-0-0-337/-Z	22658883	bulk 10 pcs.	3/8" - 1/2" 1/2" HF - 1/2" HF
73_Z-0-0-338/-Z	22658884	bulk 10 pcs.	1/2" HF - 7/8" 7/8" - 7/8"
73_Z-0-0-339/-Y	22658885	bulk (variable)	1/2" HF - 1 1/4" 1/2" HF - 1 5/8" 1/2" - 1 1/4" 1/2" - 1 5/8" 7/8" - 1 1/4" 7/8" - 1 5/8"
73_Z-0-0-340/-Y	22658886	bulk (variable)	1 1/4" - 1 1/4" 1 1/4" - 1 5/8" 1 5/8" - 1 5/8"