

CONTACTOR, AC-3, 4KW/400V, 1NC, DC 24V,  
VARISTOR INTEGR. 3-POLE, SZ S00 SPRING-  
LOADED TERMINAL

Figure similar

product brand name		SIRIUS
Product designation		Coupling relay

### General technical data:

<b>Insulation voltage</b>		
• Rated value	V	690
<b>Degree of pollution</b>		3
<b>Surge voltage resistance Rated value</b>	kV	6
<b>Mechanical service life (switching cycles)</b>		
• of the contactor typical		30 000 000
<b>Thermal short-time current restricted to 10 s</b>	A	72
<b>Protection class IP</b>		
• on the front		IP20
• of the terminal		IP20
<b>Equipment marking</b>		
• acc. to DIN EN 61346-2		Q
• acc. to DIN EN 81346-2		Q

### Main circuit:

<b>Number of poles for main current circuit</b>		3
<b>Number of NC contacts for main contacts</b>		0
<b>Number of NO contacts for main contacts</b>		3
<b>Operating voltage</b>		
• at AC-3 Rated value maximum	V	690
<b>Operating current</b>		
• at AC-1		

— at 400 V at ambient temperature 40 °C Rated value	A	22
— up to 690 V at ambient temperature 40 °C Rated value	A	22
— up to 690 V at ambient temperature 60 °C Rated value	A	20
• at AC-2 at 400 V Rated value	A	9
• at AC-3		
— at 400 V Rated value	A	9
— at 500 V Rated value	A	7.7
— at 690 V Rated value	A	6.7
• at AC-4 at 400 V Rated value	A	8.5
<b>Operating current with 1 current path</b>		
• at DC-1		
— at 24 V Rated value	A	20
— at 110 V Rated value	A	2.1
— at 220 V Rated value	A	0.8
— at 440 V Rated value	A	0.6
— at 600 V Rated value	A	0.6
• at DC-3 at DC-5		
— at 24 V Rated value	A	20
— at 110 V Rated value	A	0.1
<b>Operating current with 2 current paths in series</b>		
• at DC-1		
— at 24 V Rated value	A	20
— at 110 V Rated value	A	12
— at 220 V Rated value	A	1.6
— at 440 V Rated value	A	0.8
— at 600 V Rated value	A	0.7
• at DC-3 at DC-5		
— at 110 V Rated value	A	0.35
— at 24 V Rated value	A	20
<b>Operating current with 3 current paths in series</b>		
• at DC-1		
— at 24 V Rated value	A	20
— at 110 V Rated value	A	20
— at 220 V Rated value	A	20
— at 440 V Rated value	A	1.3
— at 600 V Rated value	A	1
• at DC-3 at DC-5		
— at 110 V Rated value	A	20
— at 220 V Rated value	A	1.5

— at 24 V Rated value	A	20
— at 440 V Rated value	A	0.2
— at 600 V Rated value	A	0.2
<b>Operating power</b>		
• at AC-1 at 400 V Rated value	kW	13
• at AC-2 at 400 V Rated value	kW	4
• at AC-4 at 400 V Rated value	kW	4
<b>Operating power</b>		
• at AC-1		
— at 230 V at 60 °C Rated value	kW	7.5
— at 230 V Rated value	kW	7.5
— at 400 V at 60 °C Rated value	kW	13
— at 690 V at 60 °C Rated value	kW	22
— at 690 V Rated value	kW	22
• at AC-3		
— at 230 V Rated value	kW	2.2
— at 400 V Rated value	kW	4
— at 690 V Rated value	kW	5.5
<b>Operating power for ≥ 200000 operating cycles at AC-4</b>		
• at 400 V Rated value	kW	2
• at 690 V Rated value	kW	2.5
<b>Operating frequency</b>		
• at AC-3 maximum	1/h	750

#### Control circuit/ Control:

<b>Type of voltage of the control supply voltage</b>		DC
<b>Control supply voltage for DC</b>		
• Rated value	V	24
<b>Operating range factor control supply voltage rated value of the magnet coil for DC</b>		0.8 ... 1.1
<b>Design of the surge suppressor</b>		with varistor
<b>Closing power of the magnet coil for DC</b>	W	4
<b>Holding power of the magnet coil for DC</b>	W	4

#### Auxiliary circuit:

<b>Number of NC contacts</b>		
• for auxiliary contacts		
— instantaneous contact		1
<b>Number of NO contacts</b>		
• for auxiliary contacts		
— instantaneous contact		0
<b>Product expansion Auxiliary switch</b>		No

<b>Operating current at AC-15</b>		
• at 230 V Rated value	A	10
• at 400 V Rated value	A	3
• at 690 V Rated value	A	1
<b>Operating current</b>		
• at DC-12 at 125 V Rated value	A	2
• at DC-12 at 220 V Rated value	A	1
• at DC-12 at 600 V Rated value	A	0.15
• at DC-13 at 125 V Rated value	A	0.9
• at DC-13 at 220 V Rated value	A	0.3
• at DC-13 at 600 V Rated value	A	0.1
<b>Operating current</b>		
• at DC-12		
— at 60 V Rated value	A	6
— at 110 V Rated value	A	3
• at DC-13		
— at 24 V Rated value	A	10
— at 60 V Rated value	A	2
— at 110 V Rated value	A	1
<b>Contact reliability of the auxiliary contacts</b>		1 faulty switching per 100 million (17 V, 1 mA)

#### UL/CSA ratings:

<b>Full-load current (FLA) for three-phase AC motor</b>		
• at 480 V Rated value	A	7.6
• at 600 V Rated value	A	9
<b>yielded mechanical performance [hp]</b>		
• for single-phase AC motor at 110/120 V Rated value	metric hp	0.33
• for single-phase AC motor at 230 V Rated value	metric hp	1
• for three-phase AC motor at 200/208 V Rated value	metric hp	2
• for three-phase AC motor at 220/230 V Rated value	metric hp	3
• for three-phase AC motor at 460/480 V Rated value	metric hp	5
• for three-phase AC motor at 575/600 V Rated value	metric hp	7.5
<b>Contact rating of the auxiliary contacts acc. to UL</b>		A600 / Q600

#### Short-circuit:

<b>Design of the fuse link</b>		
• for short-circuit protection of the main circuit		

- with type of assignment 1 required
- with type of assignment 2 required
- for short-circuit protection of the auxiliary switch required

gL/gG LV HRC 3NA, DIAZED 5SB, NEOZED 5SE:  
35 A

gL/gG LV HRC 3NA, DIAZED 5SB, NEOZED 5SE:  
20 A

fuse gL/gG: 10 A

#### Installation/ mounting/ dimensions:

<b>mounting position</b>		+/-180° rotation possible on vertical mounting surface; can be tilted forward and backward by +/- 22.5° on vertical mounting surface
<b>Mounting type</b>		screw and snap-on mounting onto 35 mm standard mounting rail according to DIN EN 50022
• Side-by-side mounting		Yes
<b>Height</b>	mm	69.5
<b>Width</b>	mm	45
<b>Depth</b>	mm	73
<b>Required spacing</b>		
• with side-by-side mounting		
— forwards	mm	0
— Backwards	mm	0
— upwards	mm	0
— downwards	mm	0
— at the side	mm	0
• for grounded parts		
— forwards	mm	0
— Backwards	mm	0
— upwards	mm	0
— at the side	mm	6
— downwards	mm	0
• for live parts		
— forwards	mm	0
— Backwards	mm	0
— upwards	mm	0
— downwards	mm	0
— at the side	mm	6

#### Connections/ Terminals:

<b>Type of electrical connection</b>		
• for main current circuit		spring-loaded terminals
• for auxiliary and control current circuit		spring-loaded terminals
<b>Type of connectable conductor cross-section</b>		
• for main contacts		
— single or multi-stranded		2x (0,5 ... 4 mm <sup>2</sup> )

— finely stranded with core end processing	2x (0.5 ... 2.5 mm <sup>2</sup> )
— finely stranded without core end processing	2x (0.5 ... 2.5 mm <sup>2</sup> )
• for AWG conductors for main contacts	2x (20 ... 12)
• for auxiliary contacts	
— single or multi-stranded	2x (0,5 ... 4 mm <sup>2</sup> )
— finely stranded with core end processing	2x (0.5 ... 2.5 mm <sup>2</sup> )
— finely stranded without core end processing	2x (0.5 ... 2.5 mm <sup>2</sup> )
• for AWG conductors for auxiliary contacts	2x (20 ... 12)

#### Safety related data:

<b>B10 value with high demand rate acc. to SN 31920</b>		1 000 000
<b>Proportion of dangerous failures</b>		
• with low demand rate acc. to SN 31920	%	40
• with high demand rate acc. to SN 31920	%	73
<b>Failure rate [FIT] with low demand rate acc. to SN 31920</b>	FIT	100
<b>Product function Mirror contact acc. to IEC 60947-4-1</b>		Yes
<b>T1 value for proof test interval or service life acc. to IEC 61508</b>	y	20
<b>Protection against electrical shock</b>		finger-safe

#### Mechanical data:





<b>Size of contactor</b>		S00
--------------------------	--	-----





#### Ambient conditions:

<b>Installation altitude at height above sea level maximum</b>	m	2 000
<b>Ambient temperature</b>		
• during operation	°C	-25 ... +60
• during storage	°C	-55 ... +80

#### Certificates/ approvals:

General Product Approval				Declaration of Conformity	Test Certificates
 CCC	 CSA		 UL	 EG-Konf.	<a href="#">Type Test Certificates/Test Report</a>

Test Certificates	Shipping Approval				
<a href="#">Special Test Certificate</a>	 ABS	 BUREAU VERITAS	 DNV	 GL	 LRS

Shipping Approval	other				
 PRS	 RINA	 RMRS	<a href="#">Environmental Confirmations</a>	 VDE	

#### Further information

**Information- and Downloadcenter (Catalogs, Brochures,...)**

<http://www.siemens.com/industrial-controls/catalogs>

**Industry Mall (Online ordering system)**

<http://www.siemens.com/industrymall>

**Cax online generator**

<http://support.automation.siemens.com/WW/CAXorder/default.aspx?lang=en&mfb=3RT20162UB42>

**Service&Support (Manuals, Certificates, Characteristics, FAQs,...)**

<http://support.automation.siemens.com/WW/view/en/3RT20162UB42/all>

**Image database (product images, 2D dimension drawings, 3D models, device circuit diagrams, EPLAN macros, ...)**

[http://www.automation.siemens.com/bilddb/cax\\_de.aspx?mfb=3RT20162UB42&lang=en](http://www.automation.siemens.com/bilddb/cax_de.aspx?mfb=3RT20162UB42&lang=en)

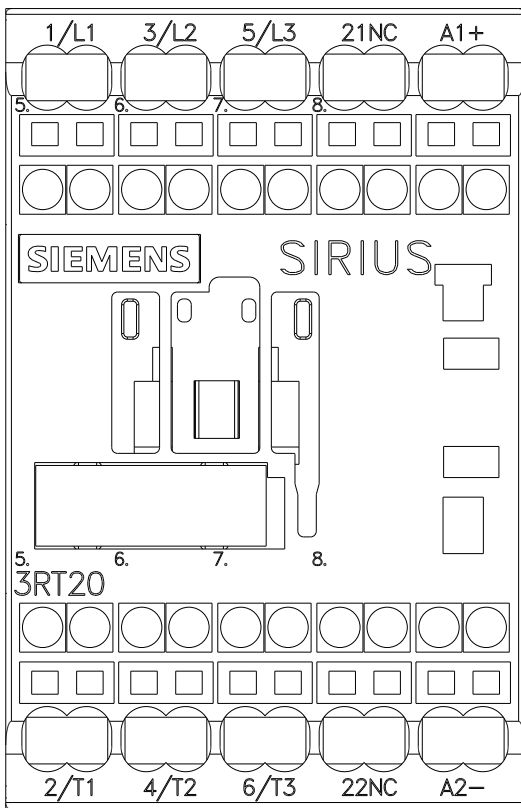
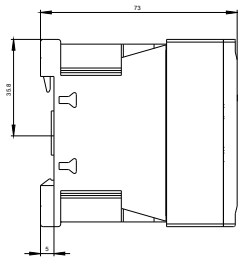



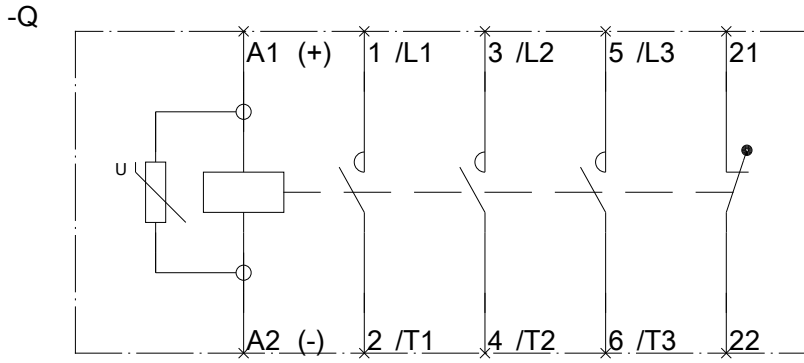

last modified:

11.03.2015