

Tru-Vue™

ML17 Series Tru-Vue™ Sensors

- Cost-effective
- Compact, versatile housing
- 4-in-1 output
- 5 connection options



4 output options from 1 sensor:
NPN normally open, NPN normally closed,
PNP normally open, or PNP normally closed

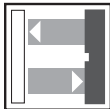

Diffused Mode

See page 438

Features:

- Sensitivity adjustment for sensing range
- 360° high-visibility LEDs

Sensing Range: 450mm

Output: 4-in-1

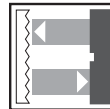

Retro-Reflective Mode

See pages 439-440

Features:

- Polarized and long-range nonpolarized models
- 360° high-visibility LEDs

Sensing Range: 3.5m, 6.5m

Output: 4-in-1



Thru-Beam Mode

See page 441

Features:

- Quick disconnect or cabled versions
- 360° high-visibility LEDs

Sensing Range: 20m

Output: 4-in-1

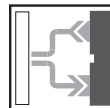

Fiber Optic Diffused and Thru-Beam Mode

See pages 442-443

Features:

- Quick attachment of plastic fiber cables
- 360° high-visibility LEDs

Sensing Range: Determined by fiber optic cable

Output: 4-in-1





See pages 443-446 for ML17 Series specifications, wiring and dimensions.

Photoelectric Sensors



Photoelectric ML17 Series Tru-Vue™



Diffused Mode

Specifications			
SENSING RANGE	10-450mm	10-450mm	10-450mm
SENSITIVITY ADJUSTMENT	Yes	Yes	Yes
REFERENCE TARGET	100 x 100mm white test card	100 x 100mm white test card	100 x 100mm white test card
MODEL NUMBER(S)	ML17-8-450/115/136	ML17-8-450/73/136	ML17-8-450/136/143
OUTPUT  /136	4-in-1*	4-in-1*	4-in-1*
SUPPLY VOLTAGE	10-30VDC	10-30VDC	10-30VDC
RESPONSE TIME	≤1.0ms	≤1.0ms	≤1.0ms
SWITCHING FREQUENCY	500Hz	500Hz	500Hz
LIGHT SOURCE	Infrared LED 950nm	Infrared LED 950nm	Infrared LED 950nm
WEIGHT	1.4oz	0.3oz	0.3oz
ELECTRICAL CONNECTION	 2-meter cable, PVC covered, 4-conductor, #26AWG	 Quick disconnect type V1, integral	 Quick disconnect type V31, integral
ADDITIONAL DATA	See pages 443-446		

*NPN normally open, NPN normally closed, PNP normally open, or PNP normally closed

Specifications		
SENSING RANGE	10-450mm	10-450mm
SENSITIVITY ADJUSTMENT	Yes	Yes
REFERENCE TARGET	100 x 100mm white test card	100 x 100mm white test card
MODEL NUMBER(S)	ML17-8-450/115b/136	ML17-8-450/115a/136
OUTPUT  /136	4-in-1*	4-in-1*
SUPPLY VOLTAGE	10-30VDC	10-30VDC
RESPONSE TIME	≤1.0ms	≤1.0ms
SWITCHING FREQUENCY	500Hz	500Hz
LIGHT SOURCE	Infrared LED 950nm	Infrared LED 950nm
WEIGHT	0.8oz	0.8oz
ELECTRICAL CONNECTION	 150mm pigtail, PVC covered, quick disconnect type V1	 150mm pigtail, PVC covered, quick disconnect type V31
ADDITIONAL DATA	See pages 443-446	



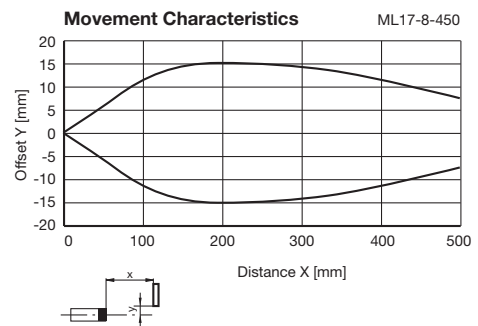
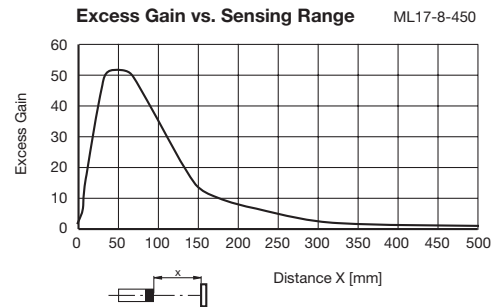

*NPN normally open, NPN normally closed, PNP normally open, or PNP normally closed

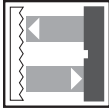
Sensing Characteristics







Retro-Reflective Mode

Specifications	0-3.5m	0-3.5m	0-3.5m
SENSING RANGE	0-3.5m	0-3.5m	0-3.5m
SENSITIVITY ADJUSTMENT	Yes	Yes	Yes
REFERENCE TARGET	FE-RR1 reflector	FE-RR1 reflector	FE-RR1 reflector
REFLECTOR DISTANCE	50mm-3.5m	50mm-3.5m	50mm-3.5m
POLARIZATION FILTER	Yes	Yes	Yes
MODEL NUMBER(S)	ML17-54/115/136	ML17-54/73/136	ML17-54/136/143
OUTPUT  /136	4-in-1*	4-in-1*	4-in-1*
SUPPLY VOLTAGE	10-30VDC	10-30VDC	10-30VDC
RESPONSE TIME	≤1.0ms	≤1.0ms	≤1.0ms
SWITCHING FREQUENCY	500Hz	500Hz	500Hz
LIGHT SOURCE	Visible red LED 626nm	Visible red LED 626nm	Visible red LED 626nm
WEIGHT	1.4oz	0.3oz	0.3oz
ELECTRICAL CONNECTION	 2-meter cable, PVC covered, 4-conductor, #26AWG	 Quick disconnect type V1, integral	 Quick disconnect type V31, integral
ADDITIONAL DATA	See pages 443-446		

*NPN normally open, NPN normally closed, PNP normally open, or PNP normally closed

Specifications	0-3.5m	0-3.5m
SENSING RANGE	0-3.5m	0-3.5m
SENSITIVITY ADJUSTMENT	Yes	Yes
REFERENCE TARGET	FE-RR1 reflector	FE-RR1 reflector
REFLECTOR DISTANCE	50mm-3.5m	50mm-3.5m
POLARIZATION FILTER	Yes	Yes
MODEL NUMBER(S)	ML17-54/115b/136	ML17-54/115a/136
OUTPUT  /136	4-in-1*	4-in-1*
SUPPLY VOLTAGE	10-30VDC	10-30VDC
RESPONSE TIME	≤1.0ms	≤1.0ms
SWITCHING FREQUENCY	500Hz	500Hz
LIGHT SOURCE	Visible red LED 626nm	Visible red LED 626nm
WEIGHT	0.8oz	0.8oz
ELECTRICAL CONNECTION	 150mm pigtail, PVC covered, quick disconnect type V1	 150mm pigtail, PVC covered, quick disconnect type V31
ADDITIONAL DATA	See pages 443-446	

*NPN normally open, NPN normally closed, PNP normally open, or PNP normally closed



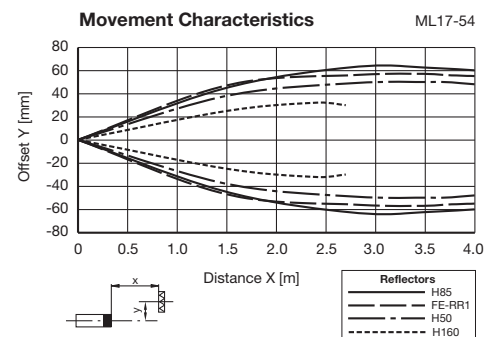
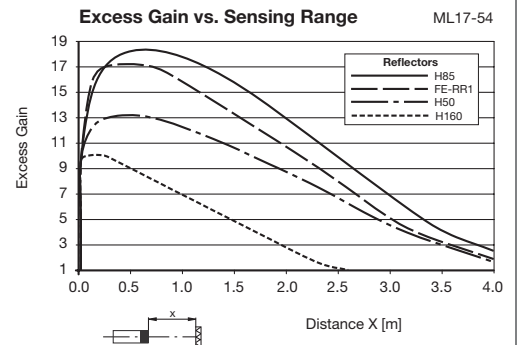

Sensing Characteristics





Photoelectric Sensors



Retro-Reflective Mode

Specifications	0-6.5m	0-6.5m	0-6.5m
SENSING RANGE	0-6.5m	0-6.5m	0-6.5m
SENSITIVITY ADJUSTMENT	Yes	Yes	Yes
REFERENCE TARGET	FE-RR1 reflector	FE-RR1 reflector	FE-RR1 reflector
REFLECTOR DISTANCE	50mm-6.5m	50mm-6.5m	50mm-6.5m
POLARIZATION FILTER	No	No	No
MODEL NUMBER(S)	ML17-6/115/136	ML17-6/73/136	ML17-6/136/143
OUTPUT  /136	4-in-1*	4-in-1*	4-in-1*
SUPPLY VOLTAGE	10-30VDC	10-30VDC	10-30VDC
RESPONSE TIME	≤1.0ms	≤1.0ms	≤1.0ms
SWITCHING FREQUENCY	500Hz	500Hz	500Hz
LIGHT SOURCE	Visible red LED 626nm	Visible red LED 626nm	Visible red LED 626nm
WEIGHT	1.4oz	0.3oz	0.3oz
ELECTRICAL CONNECTION	 2-meter cable, PVC covered, 4-conductor, #26AWG	 Quick disconnect type V1, integral	 Quick disconnect type V31, integral
ADDITIONAL DATA	See pages 443-446		

*NPN normally open, NPN normally closed, PNP normally open, or PNP normally closed

Specifications	0-6.5m	0-6.5m
SENSING RANGE	0-6.5m	0-6.5m
SENSITIVITY ADJUSTMENT	Yes	Yes
REFERENCE TARGET	FE-RR1 reflector	FE-RR1 reflector
REFLECTOR DISTANCE	50mm-6.5m	50mm-6.5m
POLARIZATION FILTER	No	No
MODEL NUMBER(S)	ML17-6/115b/136	ML17-6/115a/136
OUTPUT  /136	4-in-1*	4-in-1*
SUPPLY VOLTAGE	10-30VDC	10-30VDC
RESPONSE TIME	≤1.0ms	≤1.0ms
SWITCHING FREQUENCY	500Hz	500Hz
LIGHT SOURCE	Visible red LED 626nm	Visible red LED 626nm
WEIGHT	0.8oz	0.8oz
ELECTRICAL CONNECTION	 150mm pigtail, PVC covered, quick disconnect type V1	 150mm pigtail, PVC covered, quick disconnect type V31
ADDITIONAL DATA	See pages 443-446	



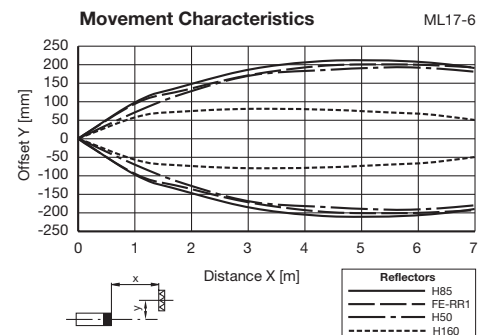
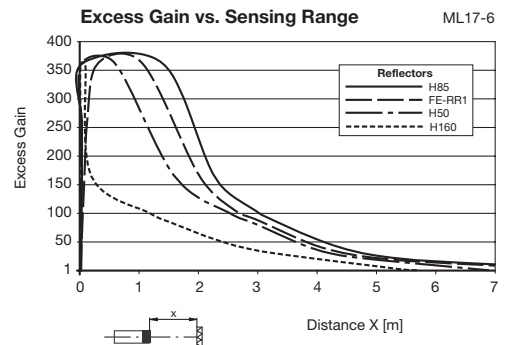

*NPN normally open, NPN normally closed, PNP normally open, or PNP normally closed

Sensing Characteristics







Thru-Beam Mode

Specifications		0-20m	0-20m	0-20m
SENSING RANGE		0-20m	0-20m	0-20m
SENSITIVITY ADJUSTMENT		No	No	No
REFERENCE TARGET		Receiver	Receiver	Receiver
MODEL NUMBER(S)	Transmitter	MD17/115	MD17/73	MD17/143
	Receiver	MV17/115/136	MV17/73/136	MV17/136/143
OUTPUT	 /136	4-in-1*	4-in-1*	4-in-1*
SUPPLY VOLTAGE		10-30VDC	10-30VDC	10-30VDC
RESPONSE TIME		≤3.0ms	≤3.0ms	≤3.0ms
SWITCHING FREQUENCY		150Hz	150Hz	150Hz
LIGHT SOURCE		Infrared LED 950nm	Infrared LED 950nm	Infrared LED 950nm
WEIGHT		1.4oz (per housing)	0.3oz (per housing)	0.3oz (per housing)
ELECTRICAL CONNECTION		 2-meter cable, PVC covered, 4-conductor, #26AWG	 Quick disconnect type V1, integral	 Quick disconnect type V31, integral
ADDITIONAL DATA		See pages 443-446		

*NPN normally open, NPN normally closed, PNP normally open, or PNP normally closed

Specifications		0-20m	0-20m
SENSING RANGE		0-20m	0-20m
SENSITIVITY ADJUSTMENT		No	No
REFERENCE TARGET		Receiver	Receiver
MODEL NUMBER(S)	Transmitter	MD17/115b	MD17/115a
	Receiver	MV17/115b/136	MV17/115a/136
OUTPUT	 /136	4-in-1*	4-in-1*
SUPPLY VOLTAGE		10-30VDC	10-30VDC
RESPONSE TIME		≤3.0ms	≤3.0ms
SWITCHING FREQUENCY		150Hz	150Hz
LIGHT SOURCE		Infrared LED 950nm	Infrared LED 950nm
WEIGHT		0.8oz (per housing)	0.8oz (per housing)
ELECTRICAL CONNECTION		 150mm pigtail, PVC covered, quick disconnect type V1	 150mm pigtail, PVC covered, quick disconnect type V31
ADDITIONAL DATA		See pages 443-446	

*NPN normally open, NPN normally closed, PNP normally open, or PNP normally closed

Sensing Characteristics

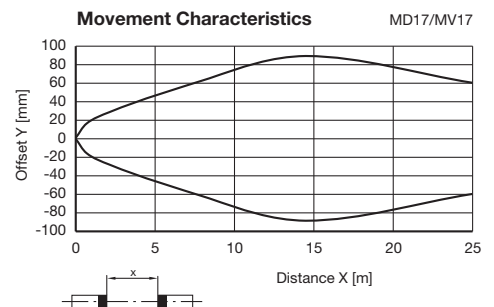
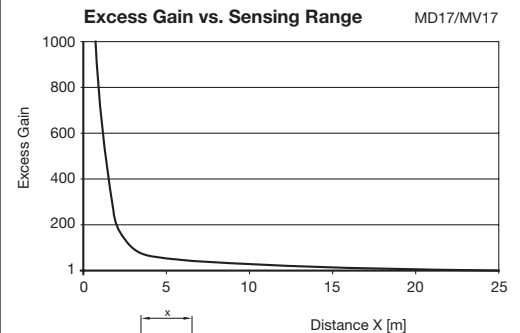





Photoelectric Sensors



Photoelectric ML17 Series Tru-Vue™



Fiber Optic Diffused and Thru-Beam Mode

Specifications			
SENSING RANGE	Determined by cable†	Determined by cable†	Determined by cable†
SENSITIVITY ADJUSTMENT	Yes	Yes	Yes
MODEL NUMBER(S)	ML17-LL-K/115/136	ML17-LL-K/73/136	ML17-LL-K/136/143
OUTPUT  /136	4-in-1*	4-in-1*	4-in-1*
SUPPLY VOLTAGE	10-30VDC	10-30VDC	10-30VDC
RESPONSE TIME	≤1.0ms	≤1.0ms	≤1.0ms
SWITCHING FREQUENCY	500Hz	500Hz	500Hz
LIGHT SOURCE	Visible red LED 670nm	Visible red LED 670nm	Visible red LED 670nm
WEIGHT	1.4oz	0.3oz	0.3oz
ELECTRICAL CONNECTION	 2-meter cable, PVC covered, 4-conductor, #26AWG	 Quick disconnect type V1, integral	 Quick disconnect type V31, integral
ADDITIONAL DATA	See pages 443-446		

*NPN normally open, NPN normally closed, PNP normally open, or PNP normally closed

Specifications		
SENSING RANGE	Determined by cable†	Determined by cable†
SENSITIVITY ADJUSTMENT	Yes	Yes
MODEL NUMBER(S)	ML17-LL-K/115b/136	ML17-LL-K/115a/136
OUTPUT  /136	4-in-1*	4-in-1*
SUPPLY VOLTAGE	10-30VDC	10-30VDC
RESPONSE TIME	≤1.0ms	≤1.0ms
SWITCHING FREQUENCY	500Hz	500Hz
LIGHT SOURCE	Visible red LED 670nm	Visible red LED 670nm
WEIGHT	0.8oz	0.8oz
ELECTRICAL CONNECTION	 150mm pigtail, PVC covered, quick disconnect type V1	 150mm pigtail, PVC covered, quick disconnect type V31
ADDITIONAL DATA	See pages 443-446	

*NPN normally open, NPN normally closed, PNP normally open, or PNP normally closed



†See pages 785-820 for plastic fiber optic lengths and specifications.





Fiber Optic Diffused and Thru-Beam Mode

Attaching Fiber Optic Cables to ML17-LL Series

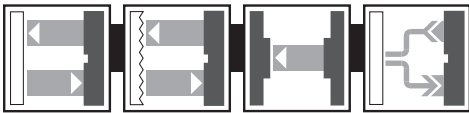
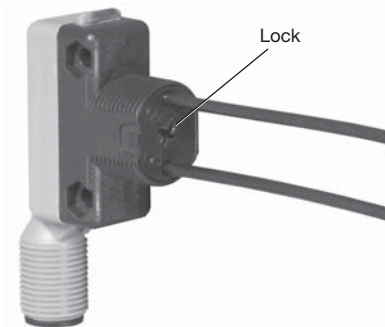
1. With a small flat screwdriver, turn the lock located on the sensor face counter-clockwise to the unlocked position.
2. Insert a standard 2.2mm diameter fiber optic cable into the housing until the cable goes no farther. For 1mm diameter cables, insert fiber ends into the adapter and then slide the adapter into the sensor until it stops.
3. Turn lock clockwise to lock the fibers.



Series Specifications

ML17 Series Specifications		
LOAD CURRENT	100mA max. per output	
LEAKAGE CURRENT	≤100µA per output	
VOLTAGE DROP	≤2VDC	
SHORT CIRCUIT AND OVERLOAD PROTECTION	Yes	
REVERSE POLARITY PROTECTION	Yes	
VOLTAGE RIPPLE	±10%	
LED(s)	Yes (2) (1 for MD17)*	
OPERATING MODE	Light on/dark on	
CURRENT CONSUMPTION	≤25mA	
READINESS DELAY	≤200ms	
PROTECTION (IEC)	IP67	
AMBIENT LIGHT RESISTANCE	≤10,000 lux	
TEMPERATURE RANGE	WORKING	-4°F to +131°F
	STORAGE	-4°F to +167°F
HOUSING MATERIAL	ABS	
LENS	Acrylic	
APPROVALS	  General Purpose	
	Yes	

*See dimensional drawings for LED functions.

Photoelectric Sensors

Wiring Diagrams

DC



Cable Connection

Normally Open

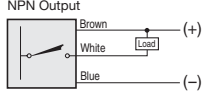

Normally Closed

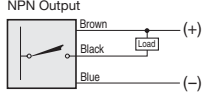

Normally Open

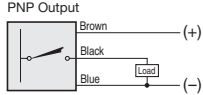

Normally Closed

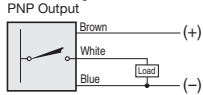

Transmitter

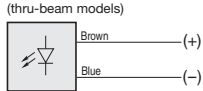

Quick Disconnect

Note: Wiring diagrams show quick disconnect pin numbers.

V1 Type

Normally Open

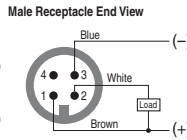
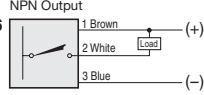

Normally Closed

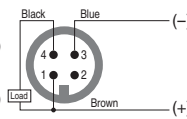
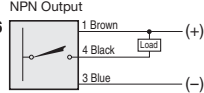

Normally Open

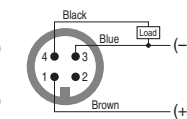
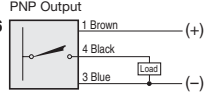

Normally Closed

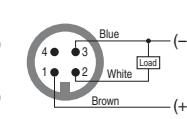
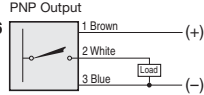

Transmitter

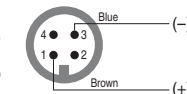
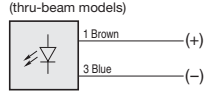

V31 Type

Normally Open

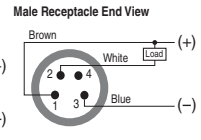
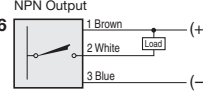

Normally Closed

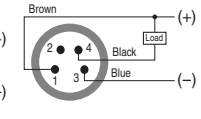
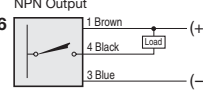

Normally Open

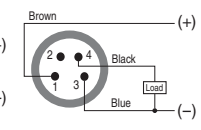
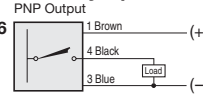

Normally Closed

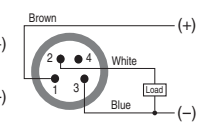
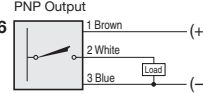

Transmitter

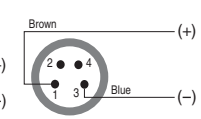
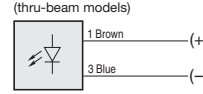

4-in-1 Output

The 4-in-1 output offers one normally open and one normally closed output, both of which automatically detect the connected load, so the outputs either source or sink current depending on the load. A single sensor can operate as NPN normally open, NPN normally closed, PNP normally open, or PNP normally closed.



See pages 827-874 for cordsets



See pages 821-826 for reflectors



See pages 885-892 for additional accessories



See pages 785-820 for plastic fiber optic lengths and specifications.

Dimensions (mm)

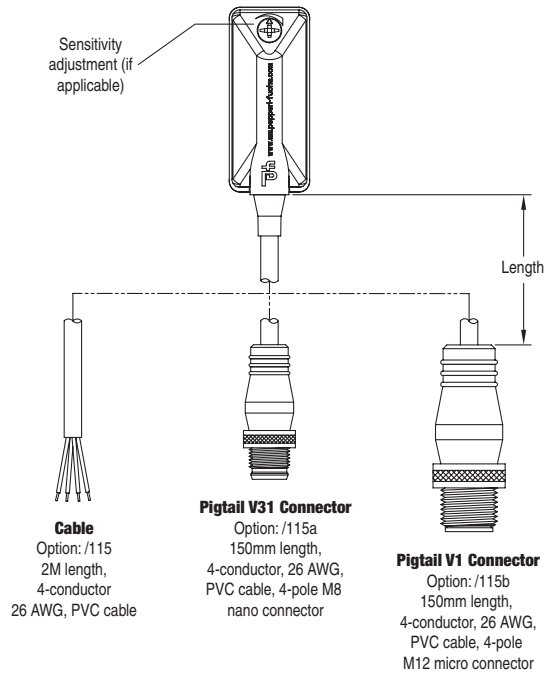
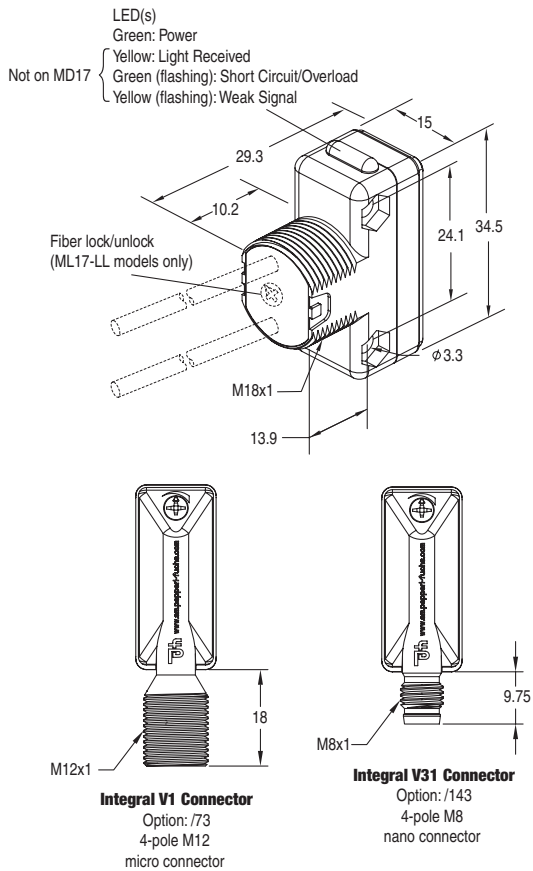

Accessories

(Dimensions in mm)

Snout-mount Mounting Bracket Model OMH-ML17 for ML17 Series sensors

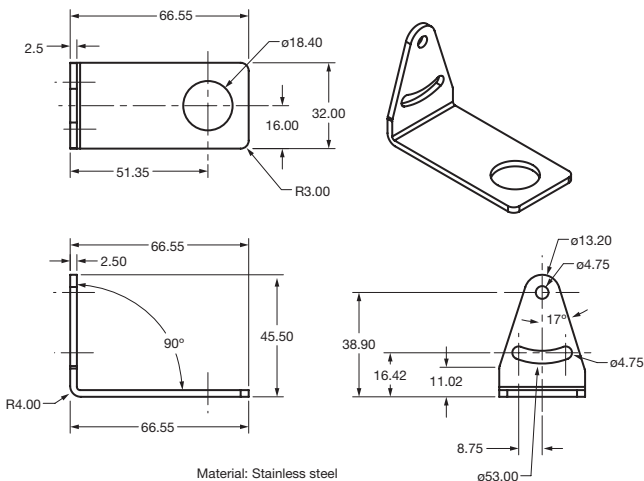

Side-mount Mounting Bracket Model OMH-ML17-1 for ML17 Series sensors

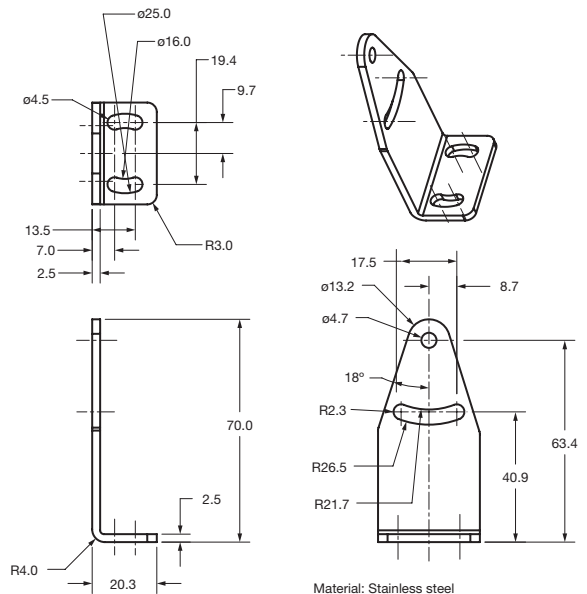

Photoelectric Sensors

Accessories (cont.)

(Dimensions in mm)

Easy-Mount Mounting Bracket Model OMH-ML17-EZ
for ML17 Series sensors. Allows rapid mount in 1 inch ($\pm 5/1000$ in.) diameter punch-out holes with no nuts, screws, or other tools required. For 10 or 12 gauge walls.)

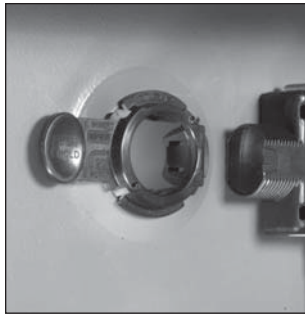
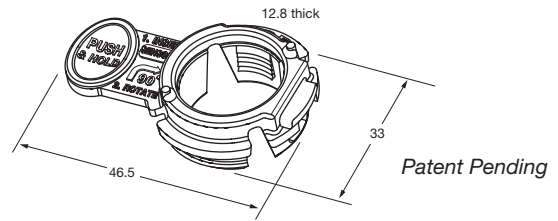

1. Insert the bracket into the 1-inch diameter punch-out hole.

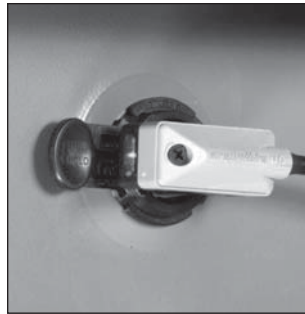

2. Insert the sensor into the bracket as shown.



3. Holding the bracket by the tab, rotate the sensor 90° clockwise.

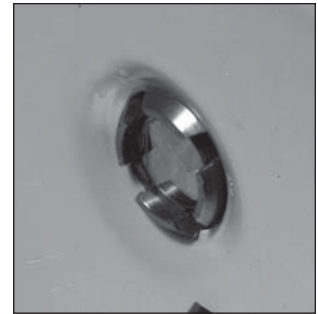

Installed sensor shown from reverse angle.

Snap-on Stainless Steel Optical Apertures
to reduce excess gain of ML17 Series sensors.

Model No.	Description
ML17-OA-05V	Vertical slotted aperture (0.5mm x 12.7mm), set of 2
ML17-OA-10V	Vertical slotted aperture (1.0mm x 12.7mm), set of 2
ML17-OA-25V	Vertical slotted aperture (2.5mm x 12.7mm), set of 2
ML17-OA-25H	Horizontal slotted aperture (6.4mm x 2.5mm), set of 2
ML17-OA-25D	Round hole aperture (2.5 diameter), set of 2
ML17-OA-KIT	Sample aperture pack, contains 1 each ML17-OA-05V, ML17-OA-10V, ML17-OA-25V, ML17-OA-25H, ML17-OA-25D

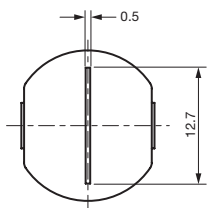

ML17-OA-05V

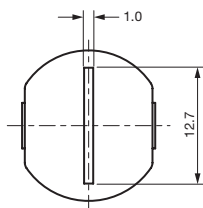

ML17-OA-10V

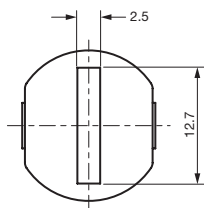

ML17-OA-25V

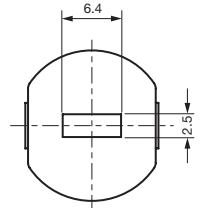

ML17-OA-25H

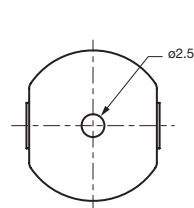

ML17-OA-25D