

PLEASE CHECK WWW.MOLEX.COM FOR LATEST PART INFORMATION

Part Number: [1722861104](#)
Status: **Active**
Overview: Ultra-Fit™ Power Connectors
Description: Ultra-Fit™ Vertical Header, 3.50mm Pitch, Single Row, 4 Circuits, with Kinked Pins, Tin, Glow Wire Capable, Black

Documents:

3D Model	Packaging Specification PK-172286-9001 (PDF)
Drawing (PDF)	RoHS Certificate of Compliance (PDF)
Product Specification PS-172323-0001 (PDF)	Product Literature (PDF)
Application Specification AS-172323-0001 (PDF)	

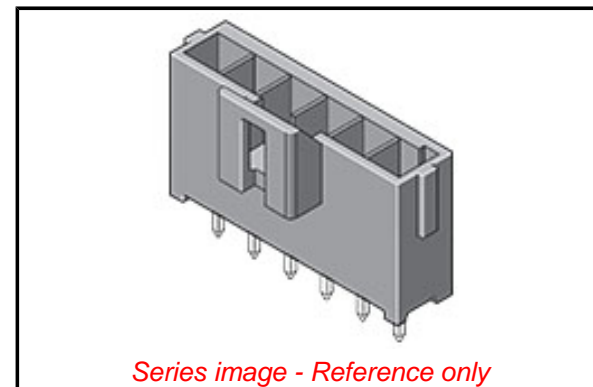

Agency Certification

CSA	LR19980
UL	E29179

General

Product Family	PCB Headers
Series	172286
Application	Power, Wire-to-Board
Comments	See Product Specification for maximum current rating by circuit size and wire AWG
Overview	Ultra-Fit™ Power Connectors
Product Literature Order No	987651-1008
Product Name	Ultra-Fit™
UPC	887191736297

Physical

Breakaway	No
Circuits (Loaded)	4
Circuits (maximum)	4
Color - Resin	Black
Durability (mating cycles max)	25
First Mate / Last Break	No
Flammability	94V-0
Glow-Wire Compliant	Yes
Guide to Mating Part	No
Keying to Mating Part	Yes
Lock to Mating Part	Yes
Material - Metal	Copper Alloy
Material - Plating Mating	Tin
Material - Plating Termination	Tin
Material - Resin	Liquid Crystal Polymer
Net Weight	1.142/g
Number of Rows	1
Orientation	Vertical
PC Tail Length	3.20mm
PCB Locator	Yes
PCB Retention	Yes
PCB Thickness - Recommended	1.60mm
Packaging Type	Tray
Pitch - Mating Interface	3.50mm
Pitch - Termination Interface	3.50mm
Plating min - Mating	1.524µm
Plating min - Termination	1.524µm
Polarized to Mating Part	Yes
Polarized to PCB	Yes

EU ELV

Not Relevant

EU RoHS

Compliant

REACH SVHC

Not Contained Per - ED/21/2016 (20 June 2016)

Halogen-Free

Status

Low-Halogen

Need more information on product environmental compliance?

Email productcompliance@molex.com
Please visit the [Contact Us](#) section for any non-product compliance questions.

China ROHS

ELV

Green Image

Not Relevant

Search Parts in this Series

[172286](#) Series

Mates With

Ultra-Fit™ Receptacle Housing [172256](#) , [172260](#)

Shrouded	Fully
Surface Mount Compatible (SMC)	Yes
Temperature Range - Operating	-40°C to +120°C
Termination Interface: Style	Through Hole - Kinked Pin

Electrical

Current - Maximum per Contact	14.0A
Voltage - Maximum	400V AC (RMS)/DC

Solder Process Data

Duration at Max. Process Temperature (seconds)	090
Lead-free Process Capability	WAVE
Max. Cycles at Max. Process Temperature	002
Process Temperature max. C	260

Material Info**Reference - Drawing Numbers**

Application Specification	AS-172323-0001
Packaging Specification	PK-172286-9001
Product Specification	PS-172323-0001
Sales Drawing	SD-172286-1000

This document was generated on 08/17/2016

PLEASE CHECK WWW.MOLEX.COM FOR LATEST PART INFORMATION