



AMP

TE Internal #: 90759-2  
 Portable Crimp Tools, Commercial Crimp Tooling, Operator  
 Releasable & Adjustable, Removable/Interchangeable, TE Product  
 Specification (114-)

[View on TE.com >](#)

Application Tooling > Portable Crimp Tools

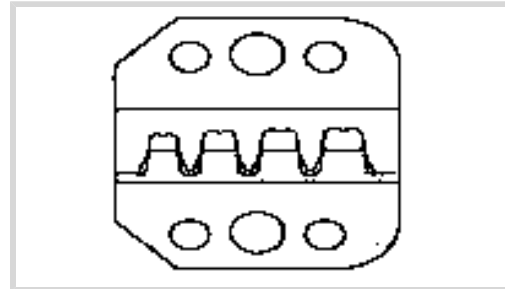

Tool Grade: **Commercial Crimp Tooling**  
 Ratchet Configuration: **Operator Releasable & Adjustable**  
 Die Sets Type: **Removable/Interchangeable**  
 Specification Type: **TE Product Specification (114-)**  
 Certification: **Upon Request for Fee**

**Features**

**Other**

Crimp Form-Wire Barrel Type	Open Barrel - F Crimp
Tool Grade	Commercial Crimp Tooling
Ratchet Configuration	Operator Releasable & Adjustable
Die Sets Type	Removable/Interchangeable
Specification Type	TE Product Specification (114-)
Certification	Upon Request for Fee
Power Type	Battery, Electric, Manual
Tool Type	Standard Die Envelope (SDE) Die Set

**Product Compliance**

[For compliance documentation, visit the product page on TE.com>](#)

EU RoHS Directive 2011/65/EU	Out of Scope
EU ELV Directive 2000/53/EC	Out of Scope
China RoHS 2 Directive MIIT Order No 32, 2016	Not reviewed for China RoHS compliance
EU REACH Regulation (EC) No. 1907/2006	Current ECHA Candidate List: JUN 2020 (209) Candidate List Declared Against: JUN 2016 (169) Does not contain REACH SVHC
Halogen Content	Not Yet Reviewed for halogen content















Solder Process Capability

Not applicable for solder process capability

Product Compliance Disclaimer

This information is provided based on reasonable inquiry of our suppliers and represents our current actual knowledge based on the information they provided. This information is subject to change. The part numbers that TE has identified as EU RoHS compliant have a maximum concentration of 0.1% by weight in homogenous materials for lead, hexavalent chromium, mercury, PBB, PBDE, DBP, BBP, DEHP, DIBP, and 0.01% for cadmium, or qualify for an exemption to these limits as defined in the Annexes of Directive 2011/65/EU (RoHS2). Finished electrical and electronic equipment products will be CE marked as required by Directive 2011/65/EU. Components may not be CE marked. Additionally, the part numbers that TE has identified as EU ELV compliant have a maximum concentration of 0.1% by weight in homogenous materials for lead, hexavalent chromium, and mercury, and 0.01% for cadmium, or qualify for an exemption to these limits as defined in the Annexes of Directive 2000/53/EC (ELV). Regarding the REACH Regulations, TE's information on SVHC in articles for this part number is still based on the European Chemical Agency (ECHA) 'Guidance on requirements for substances in articles' (Version: 2, April 2011), applying the 0.1% weight on weight concentration threshold at the finished product level. TE is aware of the European Court of Justice ruling of September 10th, 2015 also known as O5A (Once An Article Always An Article) stating that, in case of 'complex object', the threshold for a SVHC must be applied to both the product as a whole and simultaneously to each of the articles forming part of its composition. TE has evaluated this ruling based on the new ECHA "Guidance on requirements for substances in articles" (June 2017, version 4.0) and will be updating its statements accordingly.

Compatible Parts

 <p>TE Model / Part # 770987-3 MINI UMNL PIN 22-18 AWG AU LP</p>	 <p>TE Model / Part # 770903-6 MINI UMNL PIN 22-18 AWG AU</p>	 <p>TE Model / Part # 1-794228-0 MINI UMNL2 PIN 22-18 AWG AU LP</p>	 <p>TE Model / Part # 794228-1 MINI UMNL2 PIN 22-18 AWG SN LP</p>
 <p>TE Model / Part # 794137-1 MINI UMNL SOCKET 22-18 AWG SN</p>	 <p>TE Model / Part # 1-770988-1 MINI UMNL SOK 22-18AWG LP LF</p>	 <p>TE Model / Part # 170364-4 MINI UNIVERSAL M-N-L PIN LP</p>	 <p>TE Model / Part # 770904-6 MINI UMNL SOK CONT 22-18AWG AU</p>
 <p>TE Model / Part # 1-770903-1 MINI UMNL PIN 22-18 AWG AU LP</p>	 <p>TE Model / Part # 770988-3 MINI UMNL SOK 22-18AWG AU LP</p>	 <p>TE Model / Part # 794229-3 MINI UMNL2 SOK 22-18 AWG AU LP</p>	 <p>TE Model / Part # 1-770987-0 MINI UMNL PIN 22-18 AWG AU LP</p>



### Customers Also Bought

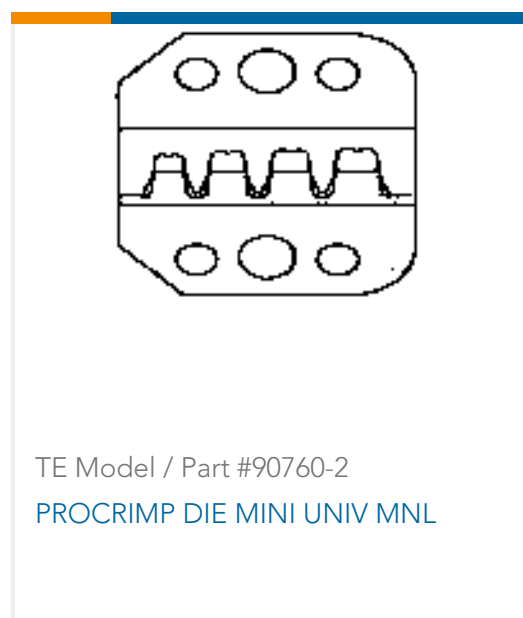

### Documents



### Datasheets & Catalog Pages

[1-1773865-2\\_1015\\_Commercial Manual Hand Tools](#)

English

[Crimp Term Whitepaper-Use the Right Tool 1-1773953-1](#)

English

[Bottoming Dies](#)

English

[CRIMPING WHERE FORM MEETS FUNCTION](#)

English

---

### Instruction Sheets

[Instruction Sheet \(U.S.\)](#)

English

[Instruction Sheet \(U.S.\)](#)

English

[PRO-CRIMPER II Hand Tool Assembly 90759-1 w/Die Assembly 90759-2](#)

English