

### Compact Illuminated Tactile Switch with 2 LEDs

- Compact construction 10 × 10 × 11 mm (W × D × H) and 12 × 12 × 11 mm (W × D × H) with bright and uniform illumination.
- Three-color illumination (red LED + green LED = orange).
- Standard force (1.57 N) and high-force (2.26 N) models.

RoHS Compliant

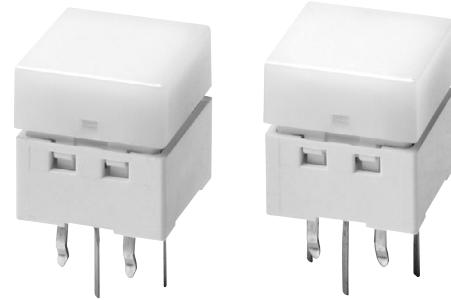

**NEW**

### Features

#### Bright and uniform illumination

- Compact construction 10 × 10 × 11 mm (W × D × H) and 12 × 12 × 11 mm (W × D × H) equipped with 2 LEDs.
- Uniquely constructed diffusion panel.

#### Three-color illumination

- Simultaneous use of red and green LEDs create a third color (orange).

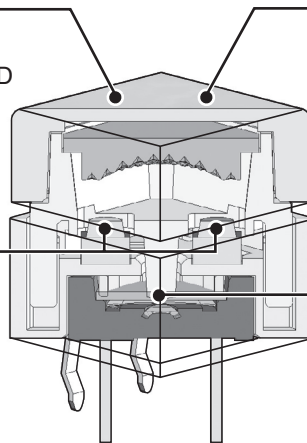

#### Snap-action contact construction for a positive click action.

- Models available with two different operating forces, standard force (1.57 N) and high-force (2.26 N).

#### High contact reliability

- Sealed construction provides high contact reliability.

### Model Number Structure

**B3W-90** □ □ - □ □ □ □  
1 2 3 4 5

#### 1. Cap width

- 0: 10 × 10 mm
- 1: 12 × 12 mm

#### 2. Operating force

- 0: Standard (OF = 1.57 N)
- 2: High-force (OF = 2.26 N)

#### 3. LED color

- R: Red
- G: Green
- HG: Green (high brightness)
- Y: Yellow
- B: Blue
- RG: Red + Green (Combination of LED colors)
- RB: Red + Blue (Combination of LED colors)

#### 4. No. of LEDs

- 1: 1
- 2: 2

#### 5. Cap

- R: Red
- G: Green
- Y: Yellow
- B: Blue
- C: Transparent
- N: Milky white

- Note:**
1. There are five colored caps or a transparent cap for Switches with single-color LEDs. There are milky white or transparent caps for Switches with two-color LEDs (combination of different-color LEDs).
  2. For Switches with two LEDs, red and green, the red and green LEDs illuminated simultaneously become orange for use as a three-color LED. A milky white cap is used.

# Ordering Information

## ■ 10 × 10-mm Switches

### Standard force

Force	LED color	No. of LEDs	Cap color	Model
Standard force (OF = 1.57 N)	Blue	1	Blue	B3W-9000-B1B
		1	Transparent	B3W-9000-B1C
		1	Milky white	B3W-9000-B1N
		2	Blue	B3W-9000-B2B
		2	Transparent	B3W-9000-B2C
		2	Milky white	B3W-9000-B2N
	Green	1	Transparent	B3W-9000-G1C
		1	Green	B3W-9000-G1G
		1	Milky white	B3W-9000-G1N
		2	Transparent	B3W-9000-G2C
		2	Green	B3W-9000-G2G
		2	Milky white	B3W-9000-G2N
	Green (high brightness)	1	Transparent	B3W-9000-HG1C
		1	Green	B3W-9000-HG1G
		1	Milky white	B3W-9000-HG1N
		2	Transparent	B3W-9000-HG2C
		2	Green	B3W-9000-HG2G
		2	Milky white	B3W-9000-HG2N
	Red	1	Transparent	B3W-9000-R1C
		1	Milky white	B3W-9000-R1N
		1	Red	B3W-9000-R1R
		2	Transparent	B3W-9000-R2C
		2	Milky white	B3W-9000-R2N
		2	Red	B3W-9000-R2R
	Red + Green	2	Transparent	B3W-9000-RG2C
		2	Milky white	B3W-9000-RG2N
	Red + High bright green	2	Transparent	B3W-9000-RHG2C
	Red + Blue	2	Transparent	B3W-9000-RB2C
	Yellow	1	Transparent	B3W-9000-Y1C
		1	Milky white	B3W-9000-Y1N
		1	Yellow	B3W-9000-Y1Y
		2	Transparent	B3W-9000-Y2C
		2	Milky white	B3W-9000-Y2N
		2	Yellow	B3W-9000-Y2Y

### High-force

Force	LED color	No. of LEDs	Cap color	Model
High-force (OF = 2.26 N)	Blue	1	Blue	B3W-9002-B1B
		1	Transparent	B3W-9002-B1C
		1	Milky white	B3W-9002-B1N
		2	Blue	B3W-9002-B2B
		2	Transparent	B3W-9002-B2C
		2	Milky white	B3W-9002-B2N
	Green	1	Transparent	B3W-9002-G1C
		1	Green	B3W-9002-G1G
		1	Milky white	B3W-9002-G1N
		2	Transparent	B3W-9002-G2C
		2	Green	B3W-9002-G2G
		2	Milky white	B3W-9002-G2N
	Green (high brightness)	1	Transparent	B3W-9002-HG1C
		1	Green	B3W-9002-HG1G
		1	Milky white	B3W-9002-HG1N
		2	Transparent	B3W-9002-HG2C
		2	Green	B3W-9002-HG2G
		2	Milky white	B3W-9002-HG2N
	Red	1	Transparent	B3W-9002-R1C
		1	Milky white	B3W-9002-R1N
		1	Red	B3W-9002-R1R
		2	Transparent	B3W-9002-R2C
		2	Milky white	B3W-9002-R2N
		2	Red	B3W-9002-R2R
	Red + Green	2	Transparent	B3W-9002-RG2C
		2	Milky white	B3W-9002-RG2N
	Red + High bright green	2	Transparent	B3W-9002-RHG2C
	Red + Blue	2	Transparent	B3W-9002-RB2C
	Yellow	1	Transparent	B3W-9002-Y1C
		1	Milky white	B3W-9002-Y1N
		1	Yellow	B3W-9002-Y1Y
		2	Transparent	B3W-9002-Y2C
		2	Milky white	B3W-9002-Y2N
		2	Yellow	B3W-9002-Y2Y

## ■ 12 × 12-mm Switches

### Standard force

Force	LED color	No. of LEDs	Cap color	Model	
Standard force (OF = 1.57 N)	Blue (high brightness)	1	Blue	B3W-9010-B1B	
		1	Milky white	B3W-9010-B1N	
		2	Blue	B3W-9010-B2B	
		2	Milky white	B3W-9010-B2N	
	Green	1	Green	B3W-9010-G1G	
		1	Milky white	B3W-9010-G1N	
		2	Green	B3W-9010-G2G	
		2	Milky white	B3W-9010-G2N	
		Green (high brightness)	1	Green	B3W-9010-HG1G
			1	Milky white	B3W-9010-HG1N
	2		Green	B3W-9010-HG2G	
	2		Milky white	B3W-9010-HG2N	
	Red	1	Red	B3W-9010-R1R	
		1	Milky white	B3W-9010-R1N	
		2	Red	B3W-9010-R2R	
		2	Milky white	B3W-9010-R2N	
	Red + Green	2	Milky white	B3W-9010-RG2N	
	Red + High bright green	2	Milky white	B3W-9010-RHG2N	
	Red + Blue	2	Milky white	B3W-9010-RB2N	
	Yellow	1	Yellow	B3W-9010-Y1Y	
1		Milky white	B3W-9010-Y1N		
2		Yellow	B3W-9010-Y2Y		
2		Milky white	B3W-9010-Y2N		

### High-force

Force	LED color	No. of LEDs	Cap color	Model	
High-force (OF = 2.26 N)	Blue	1	Blue	B3W-9012-B1B	
		1	Milky white	B3W-9012-B1N	
		2	Blue	B3W-9012-B2B	
		2	Milky white	B3W-9012-B2N	
	Green	1	Green	B3W-9012-G1G	
		1	Milky white	B3W-9012-G1N	
		2	Green	B3W-9012-G2G	
		2	Milky white	B3W-9012-G2N	
		Green (high brightness)	1	Green	B3W-9012-HG1G
			1	Milky white	B3W-9012-HG1N
	2		Green	B3W-9012-HG2G	
	2		Milky white	B3W-9012-HG2N	
	Red	1	Red	B3W-9012-R1R	
		1	Milky white	B3W-9012-R1N	
		2	Red	B3W-9012-R2R	
		2	Milky white	B3W-9012-R2N	
	Red + Green	2	Milky white	B3W-9012-RG2N	
	Red + High bright green	2	Milky white	B3W-9012-RHG2N	
	Red + Blue	2	Milky white	B3W-9012-RB2N	
	Yellow	1	Yellow	B3W-9012-Y1Y	
1		Milky white	B3W-9012-Y1N		
2		Yellow	B3W-9012-Y2Y		
2		Milky white	B3W-9012-Y2N		

## Specifications

### ■ Ratings/Characteristics (Same for Both Standard and High-force Switches)

Switching capacity	1 to 50 mA, 5 to 24 VDC (resistive load)
Ambient operating temperature	-25°C to 70°C at 60% max. humidity (with no icing or condensation)
Ambient operating humidity	35% to 85% (at 5 to 35°C)
Contact configuration	SPST-NO
Contact resistance	100 mΩ max. (initial value) (rated: 1 mA, 5 VDC)
Insulation resistance	100 MΩ min. (at 250 VDC)
Dielectric strength	500 VAC, 50/60 Hz for 1 min
Bounce time	5 ms max.
Vibration resistance	Malfunction: 10 to 55 Hz, 1.5 mm double amplitude
Shock resistance	Destruction: 1,000 m/s <sup>2</sup> {approx. 100 G} max. Malfunction: 100 m/s <sup>2</sup> {approx. 10 G} max.
Life expectancy	Switch section 1.57 N (standard force):1,000,000 operations min. 2.26 N (high-force):300,000 operations min.

### ■ Operating Characteristics

Item	Standard-force Switches (B3W-90□0)	High-force Switches (B3W-90□2)
Operating force (OF)	1.57 N max.	2.26 N max.
Releasing force (RF)	0.2 N {20 gf} min.	0.49 N min.
Pretravel (PT)	0.25 <sup>+0.2</sup> / <sub>-0.1</sub> mm	

# LED Specifications

(Ambient temperature Ta = 25°C)

LED color	Red	Green	Green (high brightness)	Yellow	Blue
Maximum operating current I <sub>FM</sub>	27 mA	27 mA	27 mA	45 mA	27 mA
Recommended operating current I <sub>F</sub>	20 mA	20 mA	10 mA	20 mA	10 mA
Forward voltage (standard value) V <sub>F</sub>	1.8 V	2.1 V	3.7 V	2.4 V	3.7 V
Maximum reverse voltage V <sub>R</sub>	5 V	5 V	5 V	5 V	5 V
Ambient operating temperature	-25°C to 70°C				

**Note:** For Switches with two LEDs, red and green, the recommended operating current is 12 mA for the red and 20 mA for the green LED for application with three-color illumination.

## LEDs

### ■ Forward current reduction curve

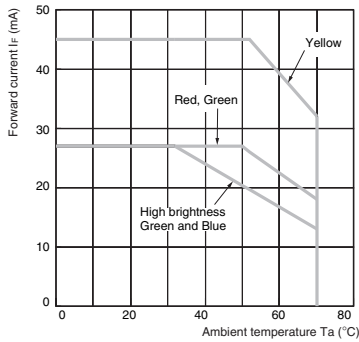

### ■ Forward current and forward voltage curves

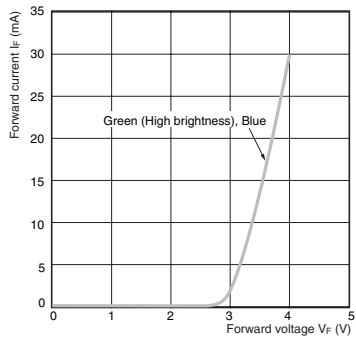
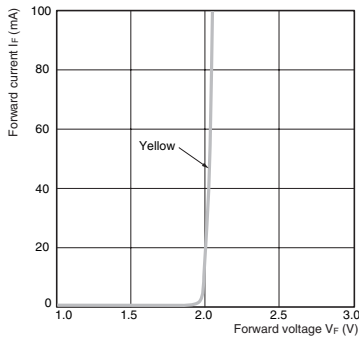
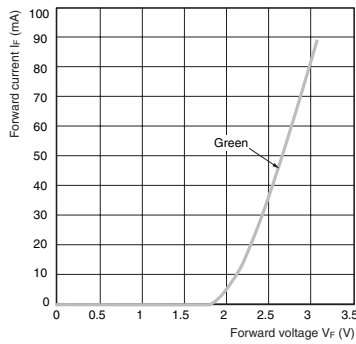
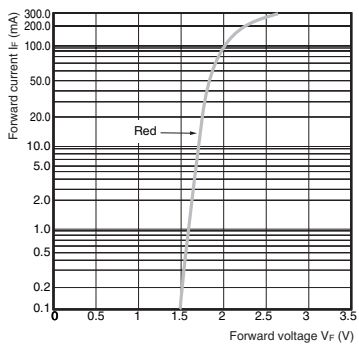

- Note:**
1. Make sure that the polarity of the LEDs is correct. The polarity is not indicated on the Switch, but the positive pole is located on the back surface of the Switch on the side with the OMRON mark.
  2. Connect limiting resistors to the LEDs. The Switch does not have built-in limiting resistors, so satisfy the LED characteristics by obtaining the limiting resistance according to the following formula based on the voltage to be used.

$$\text{Limiting resistance (R)} = \frac{\text{Voltage used (E) - LED forward voltage (V}_F\text{)}}{\text{LED forward current (I}_F\text{)}} \text{ (}\Omega\text{)}$$

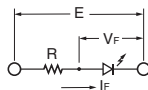

# Dimensions

**Note:** All units are in millimeters unless otherwise indicated. Unless otherwise specified, a tolerance of  $\pm 0.4$  mm applies to all dimensions.

## 1 LED Types

B3W-900□-□1□  
B3W-901□-□1□

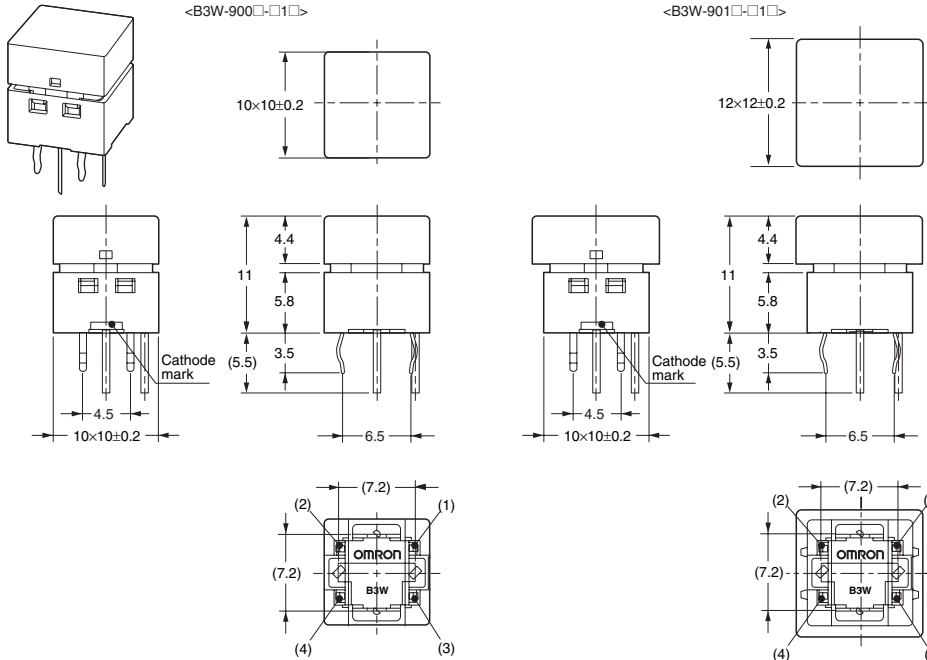

PCB Mounting (Top View)

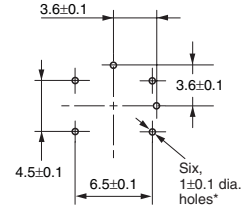

Terminal Arrangement/ Internal Connections (Top View)

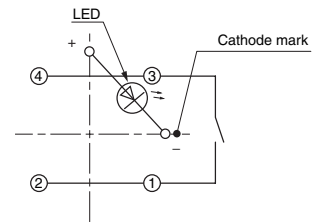

**Note:** If the poles of the LED are set incorrectly, it may result in malfunction.

**Note:** Unless otherwise specified, a tolerance of  $\pm 0.4$  mm applies to all dimensions. Terminal numbers are not printed on the Switch itself.

## 2 LED Types

B3W-900□-□2□  
B3W-901□-□2□

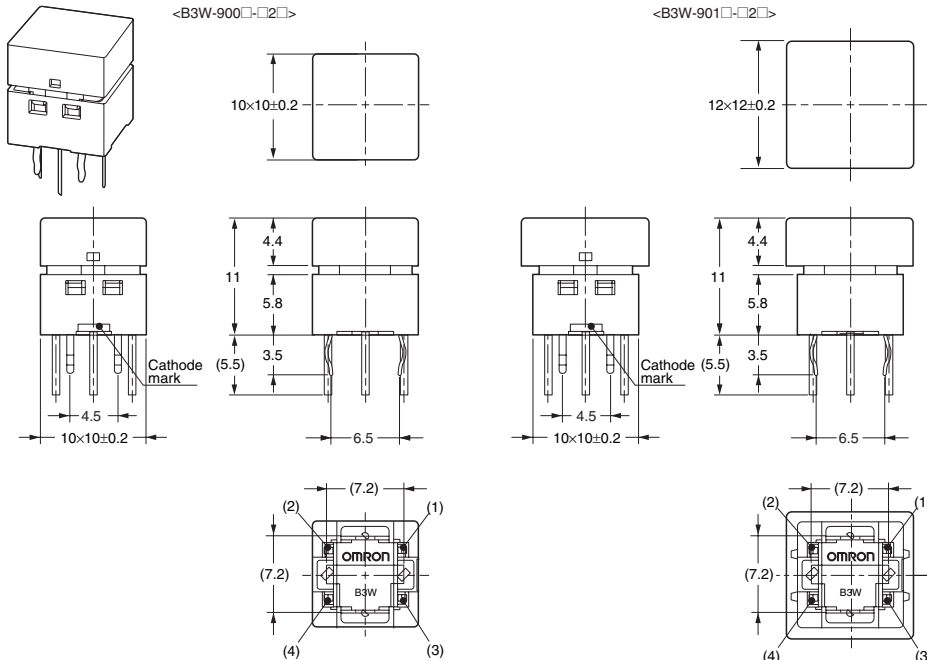

PCB Mounting (Top View)

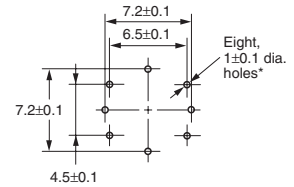

Terminal Arrangement/ Internal Connections (Top View)

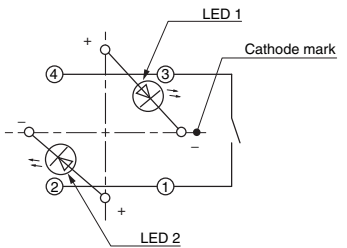

**Note 1:** If the poles of the LED are set incorrectly, it may result in malfunction.  
**Note 2:** For models with two-color LEDs, the color of LED 1 is at position LED 1. The color of LED 2 is at the position LED 2.  
B3W-900□-□RG2□  
LED 2 color  
LED 1 color

**Note:** Unless otherwise specified, a tolerance of  $\pm 0.4$  mm applies to all dimensions. Terminal numbers are not printed on the Switch itself.

## Accessories

### B3W-9□□-F□

#### Text Combination Films

#### Text Combination Films for B3W-9 Illuminated Tactile Switches

- Display two different labels in combination with a 2-LED B3W-9 Switch.
- Color combinations: Red/Green or Red/Blue



#### ■ Model Number Structure

B3W-9□□-F□  
1 2 3

##### 1. Color

R: Red

##### 2. Color

B: Blue

G: Green

##### 3. Color and text combination

F1: Red OFF  
Blue or green ON

F2: Red 切 (OFF)  
Blue or green 入 (ON)

F3: Red 閉 (CLOSE)  
Blue or green 開 (OPEN)

F4: Red ×  
Blue or green ○

F5: Red ▼  
Blue or green ▲

**Note:** 1. Five text combinations are available.

2. Films can also be customized with other text for 50 sheets (1,250 films) per lot. Delivery time is approximately five weeks. (Ask your OMRON representative for details.)

Text Combinations	LED colors	Model
"OFF" and "ON"	Red/Blue	B3W-9RB-F1
	Red/Green	B3W-9RG-F1
"切" and "入" (OFF) (ON)	Red/Blue	B3W-9RB-F2
	Red/Green	B3W-9RG-F2
"閉" and "開" (CLOSE)(OPEN)	Red/Blue	B3W-9RB-F3
	Red/Green	B3W-9RG-F3
"×" and "○"	Red/Blue	B3W-9RB-F4
	Red/Green	B3W-9RG-F4
"▼" and "▲"	Red/Blue	B3W-9RB-F5
	Red/Green	B3W-9RG-F5

#### ■ Recommended B3W-9 Switches

Operating force	2-LED Switches	Red/Blue	Red/Bright green
Standard-force Switches		B3W-9000-RB2C	B3W-9000-RHG2C
High-force Switches		B3W-9002-RB2C	B3W-9002-RHG2C

#### ■ Minimum Order

25 films/sheet

B3W-9 Films are sold in units of 25 films. Orders must be made in multiples of 25 (the quantity per sheet).

**Note:** Text Combination Films are sold without the Switches. Order one of the above models of B3W-9 Illuminated Tactile Switches separately.

# Safety Precautions

**Note:** Refer to *Safety Precautions in Tactile Switches* (Cat. No. X037) for details on general safety precautions.

## ■ Precautions for Correct Use

### Electrical Standards

Use the Switch within the rated voltage and current ranges, otherwise the Switch may have a shortened life expectancy, radiate heat, or burn out. This particularly applies to the instantaneous voltages and currents when switching.

### Soldering

#### 1. Soldering Precautions

- Before any kind of soldering, test to confirm that soldering can be performed properly. Otherwise the Switch may be deformed by the soldering heat depending on the type of PCB, pattern, or lands of the PCB.
- Do not solder the Switch more than twice, including rectification soldering. Wait for at least five minutes between the first and second soldering to allow the temperature to return to normal. Continuous soldering may cause the casing to melt or deteriorate the Switch characteristics.

#### 2. Automatic Soldering Baths (Wave Soldering)

- Soldering temperature: 260°C max.
- Soldering time: 5 s max. for a 1.6-mm thick single-side PCB
- Preheating temperature: 100°C max. (ambient temperature)
- Preheating time: Within 60 s
- Precautions  
Make sure that no flux will rise above the level of the PCB. Also make sure that flux is not applied to the switch terminals or to the mounting surface of the PCB.  
If flux overflows onto the mounting surface of the PCB, it may enter the Switch and cause a malfunction.

#### 3. Manual Soldering

- Soldering temperature: 350°C max. at the tip of the soldering iron
- Soldering time: 3 s max. for a 1.6-mm thick, single-side PCB
- Precautions: Before soldering the Switch on a PCB, make sure that there is no unnecessary space between the Switch and the PCB.

### Washing

Standard Switches are not sealed, and cannot be washed. Doing so will cause the washing agent, together with flux or dust particles on the PCB, to enter the Switch, resulting in malfunction.

### PCBs

The Switch is designed for a 1.6-mm thick, single-side PCB.

Using PCBs with a different thickness or using double-sided, through-hole PCBs may result in loose mounting, improper insertion, or poor heat resistance in soldering. These effects will occur, depending on the type of holes and patterns of the PCB. Therefore, it is recommended that a verification test is conducted before use.

### Handling

#### 1. Usage Environment

Before installing the Switch, make sure that the area of installation is not subject to corrosive gases emitted from surrounding parts.

Do not use in areas subject to high temperatures, high humidity, or toxic gases such as sulfuric gas (H<sub>2</sub>S, SO<sub>2</sub>), ammonia gas (NH<sub>3</sub>), nitric gas (HNO<sub>3</sub>), or chlorine gas (Cl<sub>2</sub>). It can cause corrosive damage to the contacts and result in malfunction.

If there is silicon in the atmosphere, it may stop the contacts from functioning properly.

If silicon products, such as silicon oil, silicon filler, or silicon wires, are used in the surrounding area, install a contact protection circuit to prevent arching or remove the silicon source.

The following situations may cause water to enter inside the Switch, resulting in a malfunction due to contact failure or corrosion.

- Using the Switch in an outdoor environment where it is exposed to water drops for an extended period of time.
- Using the Switch in an underwater setting where it is subject to strong water pressure.

Do not use Switches that have been dropped. The mating section or other internal parts may be damaged, resulting in malfunction.

### Operation

Do not repeatedly operate the Switch with excessive force. Applying excessive pressure or applying additional force after the plunger has stopped may deform the disk spring of the Switch, resulting in malfunction.

Be sure to set up the Switch so that the plunger will operate in a straight vertical line.

If the plunger is pressed off-center or from an angle it may cause deformation or damage to some parts. This may result in deterioration of durability or malfunction.

### Dust Protection

Do not install or use Switches in dust-prone environments. If a Switch must be used in this kind of environment, use a protective sheet or take other measures to protect it against dust.

**Note:** Switches with high-brightness green (HG) or blue (B) LEDs are susceptible to static electricity. Be careful when handling a Switch with these LEDs as it may cause the Switch to breakdown.

### Removing the Cap

1. Hold the cap at the side away from the mating section. Pull straight up.
2. Do not remove the cap while the Switch is mounted. Doing so will apply force to the soldered section and LEDs, resulting in malfunction.

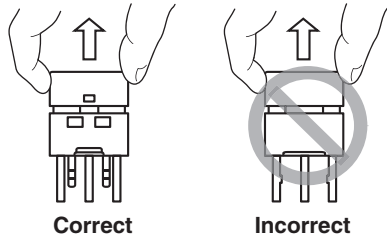

Correct

Incorrect

### Placing the Cap on the Switch

Hold the Cap at the side away from the mating section. Push straight down until the mating section meets.

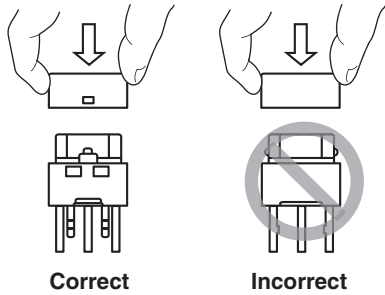

Correct

Incorrect

### Removing the Cap

The Cap can be removed up to two times. Excessively removing the Cap will cause the mating section to become weak, resulting in the operating section not mating completely or the Cap may fall off.

### Film Dimensions

Dimensions of the film are shown below. The thickness is 0.2 mm.

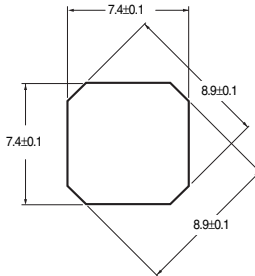

**ALL DIMENSIONS SHOWN ARE IN MILLIMETERS.**

To convert millimeters into inches, multiply by 0.03937. To convert grams into ounces, multiply by 0.03527.

### Storage Precautions

#### Storage Environment

To prevent degradation, such as discoloration, of the terminals during storage, do not store the Switch in locations that are subject to the following conditions.

1. High temperature or humidity
2. Corrosive gases
3. Direct sunlight

#### Storage condition

Store the Switches in the packaging box.

After the packaging box is opened, use the contents as quickly as possible. When storing leftover parts, make sure that appropriate measures are taken against humidity and corrosive gases.

### Agreement of Product Use

Comply with the usage, storage, and disposal conditions specified by OMRON as outlined in the precautions in the product datasheet and specifications.

Cat. No. A167-E1-04 **In the interest of product improvement, specifications are subject to change without notice.**

## OMRON Corporation

Electronic Components Company

Switch Division

Manual Switch Department

Shiokoji Horikawa, Shimogyo-ku,

Kyoto, 600-8530 Japan

Tel: (81)75-344-7096/Fax: (81)75-344-7188

0509