

Total solder points: 129

Difficulty level: *beginner* 1 2 3 4 5 *advanced*

LIQUID LEVEL CONTROLLER

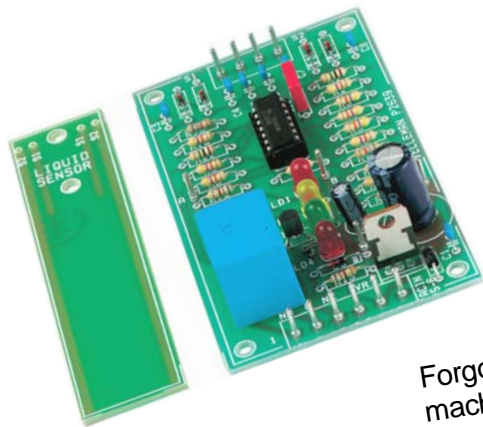

K2639

Forgotten to turn off the tap, leaking washing machines, ... Prevention is better than cure. So use this fluid detector. This multifunctional device is easy to use in a variety of applications.

Did you forget to turn off the tap? Is the washing machine leaking? Will the aquarium level fall too low? Has the rain water tank overflowed? Do you have water in the cellar? Just a minor mishap, or a disaster! You can avoid all this by installing the liquid level controller in the right way and in the right place.

- Level indicator : three LED's are used to indicate "LOW LEVEL", "MEDIUM LEVEL" and "HIGH LEVEL".
- Level controller : the relay automatically switches a pump and/or valve on and off to keep the level between "LOW" and "HIGH".
- Alarm : an "alarm" signal is available to indicate "wet" or "dry". Some applications may demand a siren (e.g. KIT K2604), or perhaps a bell or a lamp may be more suitable.

It is possible to replace the liquid sensors with other sensors, e.g. temperature or light dependent resistors (NTC/LDR) and thus use the device as a temperature/light controller.

SPECIFICATIONS:

- Power supply: 12-14VAC or 16-18VDC / 100mA
- Relay output: 240V / 3A max.
- Dimensions:
 - Controller PCB: 104 x 60mm (4.1" x 2.4")
 - Sensor PCB: 104 x 25mm (4.1" x 1.0")
- Recommended transformer: ordernr. 207004
- Recommended adapter: ordernr. PS1203

1. Assembly (Skipping this can lead to troubles !)

Ok, so we have your attention. These hints will help you to make this project successful. Read them carefully.

1.1 Make sure you have the right tools:

- A good quality soldering iron (25-40W) with a small tip.
- Wipe it often on a wet sponge or cloth, to keep it clean; then apply solder to the tip, to give it a wet look. This is called 'thinning' and will protect the tip, and enables you to make good connections. When solder rolls off the tip, it needs cleaning.
- Thin raisin-core solder. Do not use any flux or grease.
- A diagonal cutter to trim excess wires. To avoid injury when cutting excess leads, hold the lead so they cannot fly towards the eyes.
- Needle nose pliers, for bending leads, or to hold components in place.
- Small blade and Phillips screwdrivers. A basic range is fine.

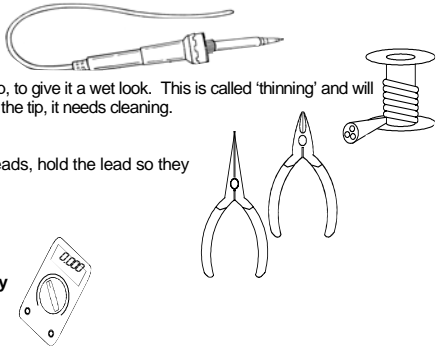

For some projects, a basic multi-meter is required, or might be handy

1.2 Assembly Hints :

- ⇒ Make sure the skill level matches your experience, to avoid disappointments.
 - ⇒ Follow the instructions carefully. Read and understand the entire step before you perform each operation.
 - ⇒ Perform the assembly in the correct order as stated in this manual
 - ⇒ Position all parts on the PCB (Printed Circuit Board) as shown on the drawings.
 - ⇒ Values on the circuit diagram are subject to changes.
 - ⇒ Values in this assembly guide are correct*
 - ⇒ Use the check-boxes to mark your progress.
 - ⇒ Please read the included information on safety and customer service
- * Typographical inaccuracies excluded. Always look for possible last minute manual updates, indicated as 'NOTE' on a separate leaflet.

1.3 Soldering Hints :

1- Mount the component against the PCB surface and carefully solder the leads

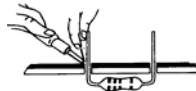

2- Make sure the solder joints are cone-shaped and shiny

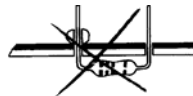

3- Trim excess leads as close as possible to the solder joint

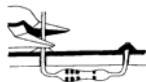

REMOVE THEM FROM THE TAPE ONE AT A TIME !

**AXIAL COMPONENTS ARE TAPED IN THE
CORRECT MOUNTING SEQUENCE !**

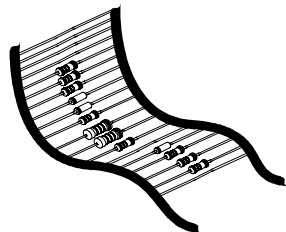

You will find the colour code for the resistances and the LEDs on our website:
<http://www.velleman.be/common/service.aspx>

1. Jumpers

J : 2x



2. Diodes. Check the polarity!

- D1 : 1N4148
- D2 : 1N4148
- D3 : 1N4148
- D4 : 1N4148
- D5 : 1N4148
- D6 : 1N4007

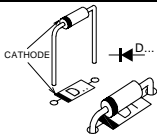

3. Resistors

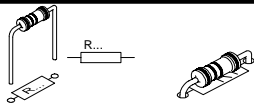

- R1 : 1M (1-0-5-B)
- R2 : 47K (4-7-3-B)
- R3 : 47K (4-7-3-B)
- R4 : 47K (4-7-3-B)
- R5 : 47K (4-7-3-B)
- R6 : 47K (4-7-3-B)
- R7 : 47K (4-7-3-B)

- R8 : 47K (4-7-3-B)
- R9 : 47K (4-7-3-B)
- R10 : 47K (4-7-3-B)
- R11 : 47K (4-7-3-B)
- R12 : 680 (6-8-1-B)
- R13 : 680 (6-8-1-B)
- R14 : 680 (6-8-1-B)
- R15 : 680 (6-8-1-B)
- R16 : 68K (6-8-3-B)
- R17 : 68K (6-8-3-B)
- R18 : 4K7 (4-7-2-B)
- R19 : 4K7 (4-7-2-B)
- R20 : 4K7 (4-7-2-B)
- R21 : 12K (1-2-3-B)
- R22 : 1M (1-0-5-B)

4. Capacitors



- C1 : 100nF (104)
- C2 : 100nF (104)
- C3 : 100nF (104)
- C4 : 100nF (104)
- C5 : 100nF (104)
- C6 : 100nF (104)

- C7 : 100nF (104)
- C8 : 100nF (104)

5. IC socket, Watch the position of the

IC1 : 14p

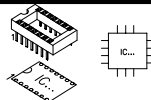

6. Transistor

T1 : BC547B

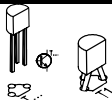

7. LEDs. Watch the polarity!

- LD1 : 5mm red
- LD2 : 5mm yellow
- LD3 : 5mm green
- LD4 : 5mm red

- LD1 : High level
- LD2 : Medium level
- LD3 : Low level
- LD4 : Relay activated

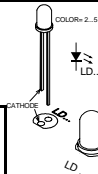

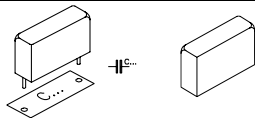
8. Capacitor

- ❑ C11 : 22nF

9. PCB pins

- ❑ Fit four terminal pins between marks S1 and S2. You may also use screw connectors.

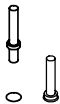

- ❑ Fit 6 terminal pins for the relay output (NO, C, NS) and the power supply (AC IN). You may also use screw connectors.

- ❑ Fit 4 terminal pins to the holes A, B, C and D

**10. Electrolytic capacitor.
Watch the polarity !**

- ❑ C9 : 10 μ F / 25V

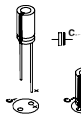
**11. Voltage regulator**

- ❑ VR1 : UA7812

☞ Check the orientation !

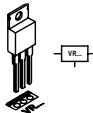
**12. Electrolytic capacitor.
Watch the polarity !**

- ❑ C10 : 1000 μ F / 35V

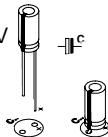
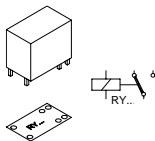
**13. Relay**

- ❑ RY1 : VR15M121C 12V / 15A

14. IC mounting

- ❑ IC1 : LM324

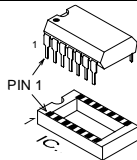

☞ Pay attention to the position of the notch!

15. Testing

👉 **Inspect the completed board thoroughly before connecting a power supply.**

- When applying a DC voltage (16 to 18V/100 mA) :

The positive input should go to the pin nearest "AC IN", the negative input to the second pin (Fig 1.0).

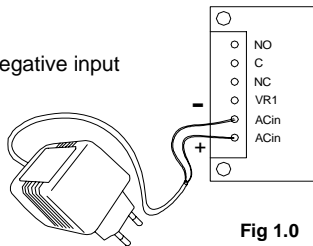

Fig 1.0

ADAPTER
(16-18VDC/100mA)

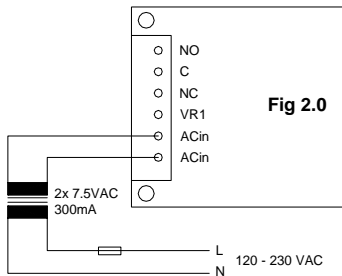

Fig 2.0

- For connecting a transformer (12 to 14V/min 300 mA):
The connection sequence isn't important (Fig 2.0).

With power on, LD3 (LOW LEVEL) should illuminate, showing that everything works.

- Put a link across low-level sensor S2, and LD2 should illuminate.

Fig 3.0

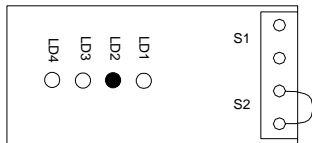

- Add another link across high-level sensor S1, and LD1 and LD4 should both illuminate.

Fig 3.1

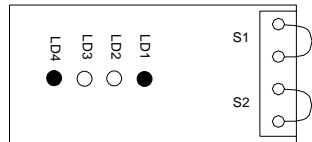

- Remove the link across input sensor S1, now LD2 should illuminate together with LD4 (relay on).

Fig 3.2

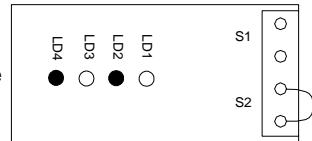

- Remove the link across input sensor S2, now only LD3 should illuminate.

Fig 3.3

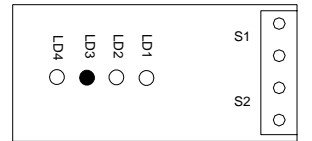

16. Applications

For application as controller/indicator and alarm, 1 or 2 sensors must be connected. A sensor consists of 2 separated electric conductors : 2 metal strips on a PCB or a jack plug etc. There are 2 sensors on the sensor PCB : S1 (HIGH LEVEL) and S2 (LOW LEVEL).

Cut a piece of your sensor PCB when the difference in height between S1 and S2 is too high for your application (Fig 4.0).

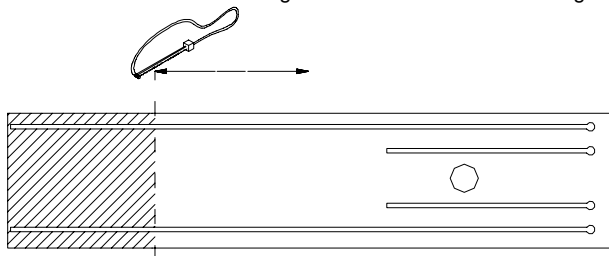

Fig 4.0

On the contrary, if the levels are too close, lengthen S2 by soldering two un-insulated wires to the copper traces (Fig 5.0).

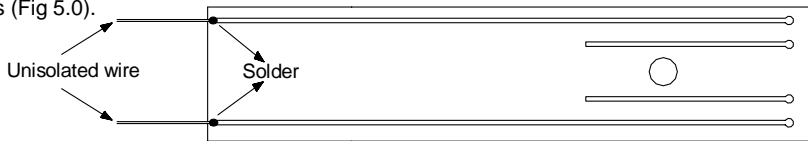

Fig 5.0

A dry sensor behaves like an electric isolator. When the sensor is wet the resistance drops to some Kilo-Ohms maximum. The electrical resistance of a sensor depends on the conductivity of the liquid, spacing between the electrodes, and the wet areas of the electrodes. The specific conductivity of some liquids is so high that this controller can't detect them. Sometimes the problem may be solved by increasing the surface of the electrodes. To avoid electrolysis or deposits on the sensor strips, the sensing voltage is alternating with a frequency around 1KHz.

NEVER USE sensors in an INFLAMMABLE ENVIRONMENT: when the sensors get dry small sparks can occur which are able to ignite pockets of gas with a resultant explosion. In a chemical environment (acids...) metal electrodes can erode. It may be necessary to construct the electrodes of an inert metal e.g. inox.

INDICATOR / CONTROLLER

Connect both sensors.

ATTENTION : Place sensor S1 higher than sensor S2

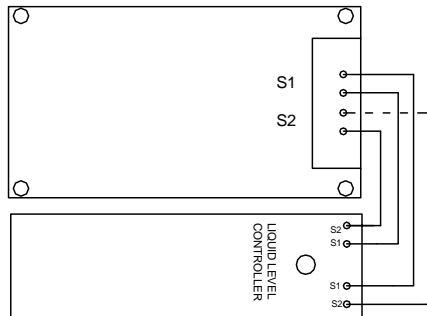

Working :

With both sensors dry, LD3 illuminates (LOW LEVEL), **fig 6.0**

When sensor S2 is wet, LD2 illuminates (MEDIUM LEVEL), **fig 6.1**

When the liquid level rises and S1 also becomes wet, LD1 (HIGH LEVEL) and LD4 (relay "on") illuminate, **fig 6.2**

If the level then falls and only sensor S2 remains wet, LD2 and LD4 illuminate, **fig 6.3**

If the level keeps falling and sensor S2 also becomes dry, only LD3 illuminates, and the relay is switched off, **fig 6.0**

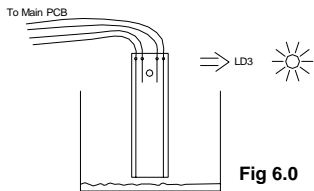

Fig 6.0

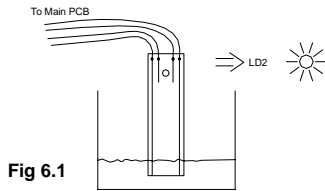

Fig 6.1

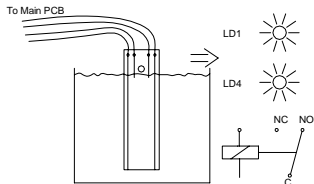

Fig 6.2

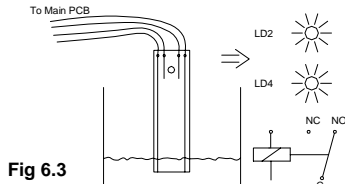

Fig 6.3

NOTE : the relay is switched on when the level reaches S1 (HIGH LEVEL) and is then switched off when the level falls under S2 (LOW LEVEL)

ATTENTION : The relay contacts are rated at 3 Amps max.

ALARM

Link the pins of sensor S1 to the pins of sensor S2 as follows :

- 1) link the pin near C5 to the pin near C6
- 2) link the pin near C4 to the pin near C7

Connect pins adjacent to C4 and C5 to a sensor. When dry, LD3 illuminates (Fig 7.0). When wet, LD1 and LD4 will illuminate and the relay is energized (Fig 7.1). The NORMALLY OPEN contact gives a “wet” alarm signal. The alarm will keep going for as long as the detected condition is present. Multiple sensors may be connected in parallel.

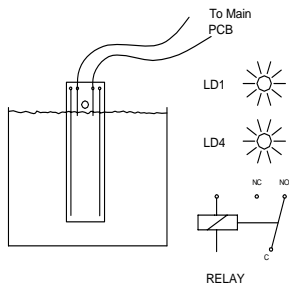
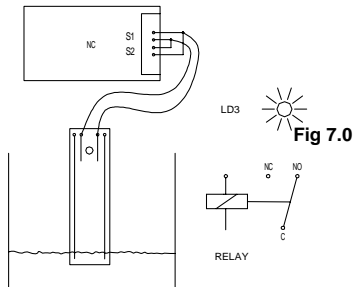

ALARM WITH HOLD MEMORY

I. Alarm when the sensor detects liquid :

Mount liquid sensor S1 and connect a NC pushbutton with the connection pins of sensor S2. As soon as the sensor detects liquid, the relay receives power (LED LD4 starts burning) and remains powered, even when the sensor returns to a dry state. The alarm device is activated through the NO relay. The alarm cannot be switched off before the sensor has stopped detecting liquid. When this is the case, press the pushbutton to switch the alarm off.

A next liquid detection will reactivate the alarm.

II. Alarm when the sensor does not detect liquid

Mount liquid sensor S2 and connect a NO pushbutton with the connection pins of sensor S1. Connect the alarm device in series With the NC relay. If the alarm should be active after mounting, press the pushbutton to switch it off. If the sensor does not detect liquid, even for the briefest of moments, the relay will switch and the alarm will become active. The alarm cannot be switched off until the sensor detects liquid again. Push the pushbutton briefly: the relay is powered and the alarm is switched off.

17. Schematic diagram.

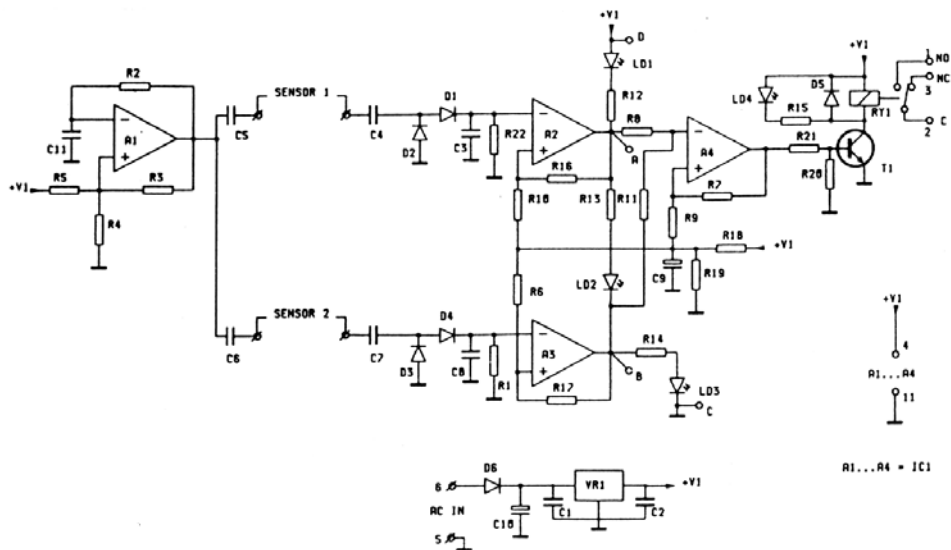

18. PCB

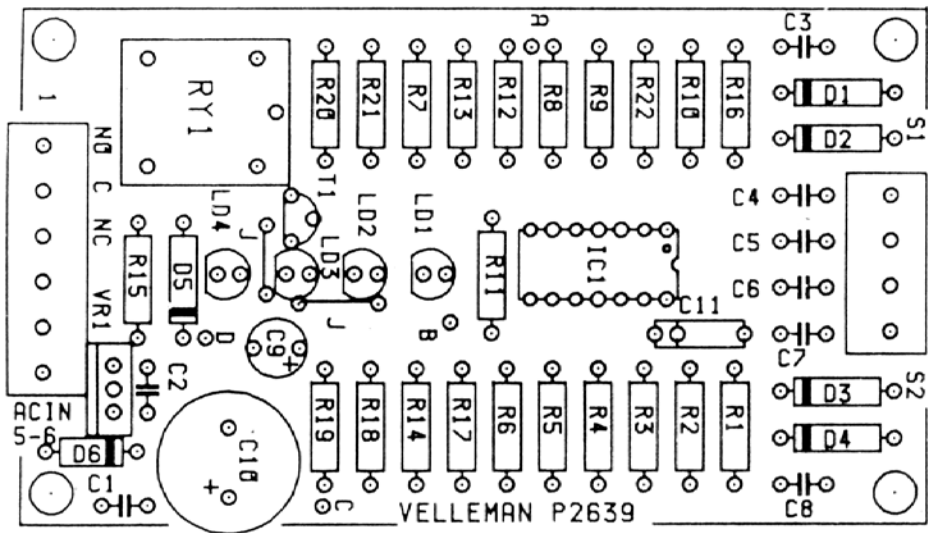



Modifications and typographical errors reserved
© Velleman Components nv.
H2639IP - 2004 - ED1 (rev.1.0)

