

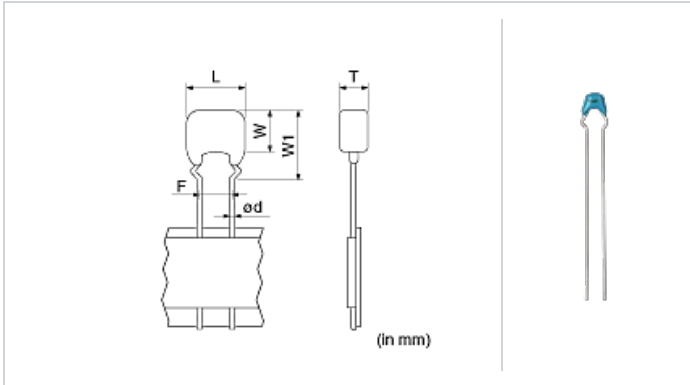

< List of part numbers with package codes >
RDE5C2A180J0S1H03A

Shape



| | |
|---------------------------------|-----------------|
| L size or outer diameter D (mm) | 5.0 mm max. |
| W size | 3.5 mm max. |
| T size | 2.5 mm max. |
| Lead spacing F | 2.5 +0.4/-0.2mm |
| Lead diameter d | 0.5 ±0.05mm |
| W1 size (max.) | 6.0mm |

Notes

Meet LF(Lead Free)[*LF : Lead content is less than 1000 ppm.],
HF(Halogen Free)

References

| Packaging | Specifications | Minimum quantity |
|-----------|-----------------------|------------------|
| A | Ammo pack taping type | 2000 |

Specifications

| | |
|--|--|
| Capacitance | 18pF ±5% |
| Rated voltage | 100Vdc |
| Temperature characteristics (complied standard) | C0G(EIA) |
| Temperature coefficient | 25 to 125°C: 0±30ppm/°C -55 to 25°C: 0+30/-72ppm/°C |
| Temperature range of temperature characteristics | -55 to 125°C |
| Operating temperature range | -55 to 125°C |

⚠ Attention

- 1.This datasheet is downloaded from the website of Murata Manufacturing Co., Ltd. Therefore, it's specifications are subject to change or our products in it may be discontinued without advance notice. Please check with our sales representatives or product engineers before ordering.
- 2.This datasheet has only typical specifications because there is no space for detailed specifications. Therefore, please review our product specifications or consult the approval sheet for product specifications before ordering.