



Features

- RoHS compliant*
- Surface Mount SMA package
- Standoff Voltage: 5.0 to 495 volts
- Power Dissipation: 400 watts
- UL Recognized

Applications

- IEC 61000-4-2 ESD (Min. Level 4)
- IEC 61000-4-4 EFT
- IEC 61000-4-5 Surge

SMAJ Transient Voltage Suppressor Diode Series

General Information

The markets of portable communications, computing and video equipment are challenging the semiconductor industry to develop increasingly smaller electronic components.

Bourns offers Transient Voltage Suppressor Diodes for surge and ESD protection applications, in compact chip package DO-214AC (SMA) size format. The Transient Voltage Suppressor series offers a choice of Working Peak Reverse Voltage from 5 V up to 495 V and Breakdown Voltage up to 550 V. Typical fast response times are less than 1.0 picoseconds for unidirectional devices and less than 5.0 picoseconds for bidirectional devices from 0 V to Minimum Breakdown Voltage.

Bourns® Chip Diodes conform to JEDEC standards, are easy to handle with standard pick and place equipment and the flat configuration minimizes roll away.

Agency Recognition

Description	
UL	File Number: E153537

Electrical Characteristics (@ T_A = 25 °C Unless Otherwise Noted)

Parameter	Symbol	Value	Unit
Minimum Peak Pulse Power Dissipation (T _p = 1 ms) (Note 1,2)	P _{PK}	400	Watts
Peak Forward Surge Current 8.3 ms Single Half Sine Wave Superimposed on Rated Load (JEDEC Method) (Note 3)	I _{FSM}	40	Amps
Steady State Power Dissipation @ TL = 75 °C	P _{M(AV)}	1.0	Watts
Maximum Instantaneous Forward Voltage @ I _{PP} = 35 A (For Unidirectional Units Only)	V _F	SMAJ5.0A ~ SMAJ90A SMAJ100A ~ SMAJ495A 3.5 5.0	Volts
Operating Temperature Range	T _J	-55 to +150	°C
Storage Temperature Range	T _{STG}	-55 to +150	°C

1. Non-repetitive current pulse, per Pulse Waveform graph and derated above T_A = 25 °C per Pulse Derating Curve.
2. Thermal Resistance Junction to Lead.
3. 8.3 ms Single Half-Sine Wave duty cycle = 4 pulses maximum per minute (unidirectional units only).

BOURNS®

Asia-Pacific:

Tel: +886-2 2562-4117
Email: asiacus@bourns.com

Europe:

Tel: +36 88 885 877
Email: eurocus@bourns.com

The Americas:

Tel: +1-951 781-5500
Email: americus@bourns.com

www.bourns.com

How to Order

Package	SMAJ	5.0	CA - H
SMAJ = SMA/DO-214AC			
Working Peak Reverse Voltage	5.0 = 5.0 V _{RWM} (Volts)		
Suffix	A = 5 % Tolerance Unidirectional Device CA = 5 % Tolerance Bidirectional Device		
Reel	(blank) = 13 inch reel -H = 7 inch reel		



WARNING Cancer and Reproductive Harm - www.P65Warnings.ca.gov

*RoHS Directive 2015/863, Mar 31, 2015 and Annex.

Specifications are subject to change without notice.

Users should verify actual device performance in their specific applications.

The products described herein and this document are subject to specific legal disclaimers as set forth on the last page of this document, and at www.bourns.com/docs/legal/disclaimer.pdf.

SMAJ Transient Voltage Suppressor Diode Series

BOURNS®

Electrical Characteristics (@ T_A = 25 °C Unless Otherwise Noted)

Unidirectional Device		Bidirectional Device		Breakdown Voltage V _{BR} (Volts)			Working Peak Reverse Voltage	Maximum Reverse Leakage @ V _{RWM}	Maximum Clamping Voltage @ I _{pp} (10/1000 μs)	Maximum Peak Pulse Current (10/1000 μs)	Maximum Clamping Voltage @ I _{pp} (8/20 μs)	Maximum Peak Pulse Current (8/20 μs)
Part No.	Marking	Part No.	Marking	Min.	Max.	@ I _T (mA)	V _{RWM} (V)	I _R (μA)	V _c (V)	I _{pp} (A)	V _c (V)	I _{pp} (A)
SMAJ5.0A	HE	SMAJ5.0CA	TE	6.40	7.00	10	5.0	800	9.2	43.5	12.0	217.5
SMAJ6.0A	HG	SMAJ6.0CA	TG	6.67	7.37	10	6.0	800	10.3	38.8	13.4	194.0
SMAJ6.5A	HK	SMAJ6.5CA	TK	7.22	7.98	10	6.5	500	11.2	35.7	14.6	178.5
SMAJ7.0A	HM	SMAJ7.0CA	TM	7.78	8.60	10	7.0	200	12.0	33.3	15.6	166.5
SMAJ7.5A	HP	SMAJ7.5CA	TP	8.33	9.21	1.0	7.5	100	12.9	31.0	16.8	155.0
SMAJ8.0A	HR	SMAJ8.0CA	TR	8.89	9.83	1.0	8.0	50	13.6	29.4	17.7	147.0
SMAJ8.5A	HT	SMAJ8.5CA	TT	9.44	10.4	1.0	8.5	20	14.4	27.8	18.7	139.0
SMAJ9.0A	HV	SMAJ9.0CA	TV	10.0	11.1	1.0	9.0	10	15.4	26.0	20.0	130.0
SMAJ10A	HX	SMAJ10CA	TX	11.1	12.3	1.0	10	5	17.0	23.5	22.1	117.5
SMAJ11A	HZ	SMAJ11CA	TZ	12.2	13.5	1.0	11	1.0	18.2	22.0	23.7	110.0
SMAJ12A	IE	SMAJ12CA	UE	13.3	14.7	1.0	12	1.0	19.9	20.1	25.9	100.5
SMAJ13A	IG	SMAJ13CA	UG	14.4	15.9	1.0	13	1.0	21.5	18.6	28.0	93.0
SMAJ14A	IK	SMAJ14CA	UK	15.6	17.2	1.0	14	1.0	23.2	17.2	30.2	86.0
SMAJ15A	IM	SMAJ15CA	UM	16.7	18.5	1.0	15	1.0	24.4	16.4	31.7	82.0
SMAJ16A	IP	SMAJ16CA	UP	17.8	19.7	1.0	16	1.0	26.0	15.4	33.8	77.0
SMAJ17A	IR	SMAJ17CA	UR	18.9	20.9	1.0	17	1.0	27.6	14.5	35.9	72.5
SMAJ18A	IT	SMAJ18CA	UT	20.0	22.1	1.0	18	1.0	29.2	13.7	38.0	68.5
SMAJ20A	IV	SMAJ20CA	UV	22.2	24.5	1.0	20	1.0	32.4	12.3	42.1	61.5
SMAJ22A	IX	SMAJ22CA	UX	24.4	26.9	1.0	22	1.0	35.5	11.3	46.2	56.5
SMAJ24A	IZ	SMAJ24CA	UZ	26.7	29.5	1.0	24	1.0	38.9	10.3	50.6	51.5
SMAJ26A	JE	SMAJ26CA	VE	28.9	31.9	1.0	26	1.0	42.1	9.5	54.7	47.5
SMAJ28A	JG	SMAJ28CA	VG	31.1	34.4	1.0	28	1.0	45.4	8.8	59.0	44.0
SMAJ30A	JK	SMAJ30CA	VK	33.3	36.8	1.0	30	1.0	48.4	8.3	62.9	41.5
SMAJ33A	JM	SMAJ33CA	VM	36.7	40.6	1.0	33	1.0	53.3	7.5	69.3	37.5
SMAJ36A	JP	SMAJ36CA	VP	40	44.2	1.0	36	1.0	58.1	6.9	75.5	34.5
SMAJ40A	JR	SMAJ40CA	VR	44.4	49.1	1.0	40	1.0	64.5	6.2	83.9	31.0
SMAJ43A	JT	SMAJ43CA	VT	47.8	52.8	1.0	43	1.0	69.4	5.8	90.2	29.0
SMAJ45A	JV	SMAJ45CA	VV	50	55.3	1.0	45	1.0	72.7	5.5	94.5	27.5
SMAJ48A	JX	SMAJ48CA	VX	53.3	58.9	1.0	48	1.0	77.4	5.2	100.6	26.0
SMAJ51A	JZ	SMAJ51CA	VZ	56.7	62.7	1.0	51	1.0	82.4	4.9	107.1	24.5
SMAJ54A	RE	SMAJ54CA	WE	60	66.3	1.0	54	1.0	87.1	4.6	113.2	23.0
SMAJ58A	RG	SMAJ58CA	WG	64.4	71.2	1.0	58	1.0	93.6	4.3	121.7	21.5
SMAJ60A	RK	SMAJ60CA	WK	66.7	73.7	1.0	60	1.0	96.8	4.1	125.8	20.5
SMAJ64A	RM	SMAJ64CA	WM	71.1	78.6	1.0	64	1.0	103	3.9	133.9	19.5
SMAJ70A	RP	SMAJ70CA	WP	77.8	86.0	1.0	70	1.0	113	3.5	146.9	17.5
SMAJ75A	RR	SMAJ75CA	WR	83.3	92.1	1.0	75	1.0	121	3.3	157.3	16.5
SMAJ78A	RT	SMAJ78CA	WT	86.7	95.8	1.0	78	1.0	126	3.2	163.8	16.0
SMAJ85A	RV	SMAJ85CA	WV	94.4	104	1.0	85	1.0	137	2.9	178.1	14.5
SMAJ90A	RX	SMAJ90CA	WX	100	111	1.0	90	1.0	146	2.7	189.8	13.5
SMAJ100A	RZ	SMAJ100CA	WZ	111	123	1.0	100	1.0	162	2.5	210.6	12.5
SMAJ110A	SE	SMAJ110CA	XE	122	135	1.0	110	1.0	177	2.3	230.1	11.5
SMAJ120A	SG	SMAJ120CA	XG	133	147	1.0	120	1.0	193	2.1	250.9	10.5
SMAJ130A	SK	SMAJ130CA	XK	144	159	1.0	130	1.0	209	1.9	271.7	9.5
SMAJ150A	SM	SMAJ150CA	XM	167	185	1.0	150	1.0	243	1.6	315.9	8.0
SMAJ160A	SP	SMAJ160CA	XP	178	197	1.0	160	1.0	259	1.5	336.7	7.5
SMAJ170A	SR	SMAJ170CA	XR	189	209	1.0	170	1.0	275	1.5	357.5	7.5
SMAJ180A	ST	SMAJ180CA	XT	201	222	1.0	180	1.0	292	1.4	379.6	7.0
SMAJ200A	SV	SMAJ200CA	XV	224	247	1.0	200	1.0	324	1.2	421.2	6.0
SMAJ220A	SX	SMAJ220CA	XX	246	272	1.0	220	1.0	356	1.1	462.8	5.5
SMAJ250A	SZ	SMAJ250CA	XZ	279	309	1.0	250	1.0	405	1.0	526.5	5.0
SMAJ300A	FE	SMAJ300CA	GE	335	371	1.0	300	1.0	486	0.8	631.8	4.0
SMAJ350A	FG	SMAJ350CA	GG	391	432	1.0	350	1.0	567	0.7	737.1	3.5
SMAJ400A	FK	SMAJ400CA	GK	447	494	1.0	400	1.0	648	0.6	842.4	3.0
SMAJ434A	434U	SMAJ434CA	434D	485	535	1.0	434	1.0	698	0.6	907.4	2.9
SMAJ440A	FM	SMAJ440CA	GM	492	543	1.0	440	1.0	713	0.6	926.9	3.0
SMAJ495A	495U	SMAJ495CA	495D	522	578	1.0	495	1.0	760	0.5	988.0	2.6

Notes: 1. Suffix 'A' denotes a 5 % tolerance unidirectional device. 3. For bidirectional devices with a V_R of 10 volts or less, the I_R limit is double.
 2. Suffix 'CA' denotes a 5 % tolerance bidirectional device.

Specifications are subject to change without notice.

Users should verify actual device performance in their specific applications.

The products described herein and this document are subject to specific legal disclaimers as set forth on the last page of this document, and at www.bourns.com/docs/legal/disclaimer.pdf.

SMAJ Transient Voltage Suppressor Diode Series



Product Dimensions

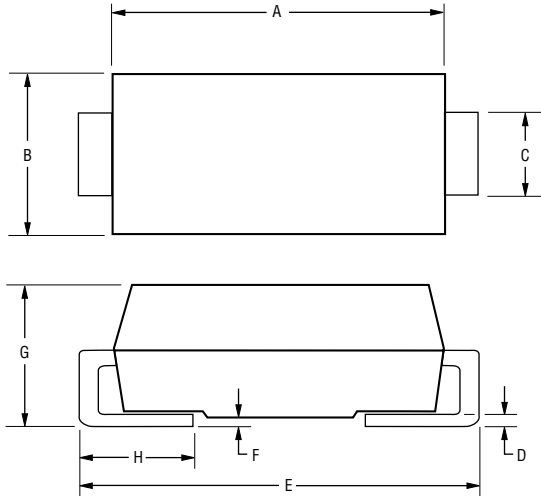

Dimension	SMA (DO-214AC)
A	$\frac{3.99 - 4.50}{(0.157 - 0.177)}$
B	$\frac{2.54 - 2.79}{(0.100 - 0.110)}$
C	$\frac{1.25 - 1.65}{(0.049 - 0.065)}$
D	$\frac{0.15 - 0.31}{(0.006 - 0.012)}$
E	$\frac{4.93 - 5.28}{(0.194 - 0.208)}$
F	$\frac{0.203}{(0.008)}$ MAX.
G	$\frac{1.98 - 2.29}{(0.078 - 0.090)}$
H	$\frac{0.76 - 1.52}{(0.030 - 0.060)}$

Recommended Footprint

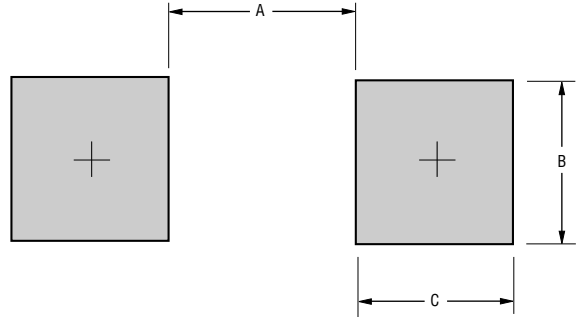

Dimension	SMA (DO-214AC)
A (Max.)	$\frac{2.70}{(0.106)}$
B (Min.)	$\frac{2.10}{(0.083)}$
C (Min.)	$\frac{1.27}{(0.050)}$

DIMENSIONS: $\frac{\text{MM}}{\text{(INCHES)}}$

Physical Specifications

CaseMolded plastic per UL Class 94V-0
 Polarity..... Cathode band indicates unidirectional device
 No cathode band indicates bidirectional device
 Weight0.064 grams

Typical Part Marking

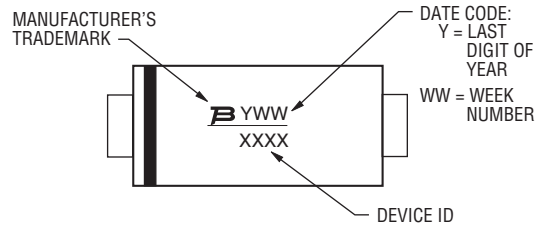

Specifications are subject to change without notice.

Users should verify actual device performance in their specific applications.

The products described herein and this document are subject to specific legal disclaimers as set forth on the last page of this document, and at www.bourns.com/docs/legal/disclaimer.pdf.

SMAJ Transient Voltage Suppressor Diode Series



Rating & Characteristic Curves

Pulse Derating Curve

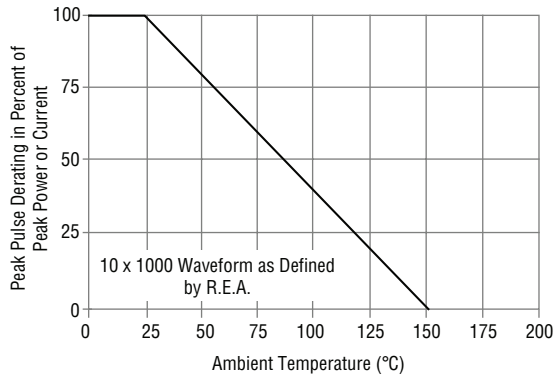

Maximum Non-Repetitive Surge Current

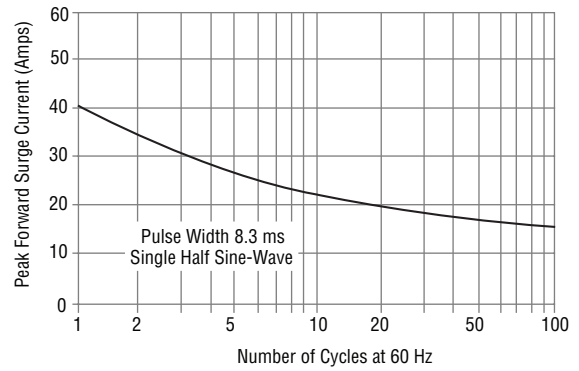

Pulse Waveform

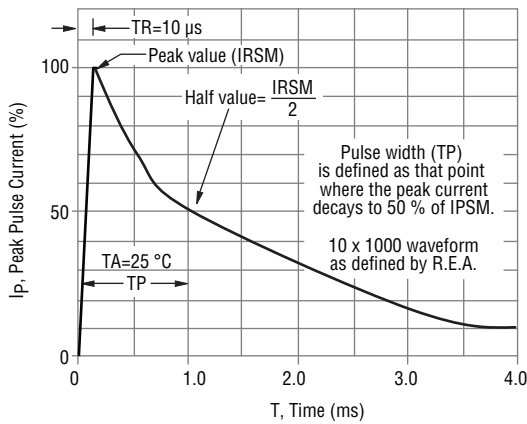

Typical Junction Capacitance

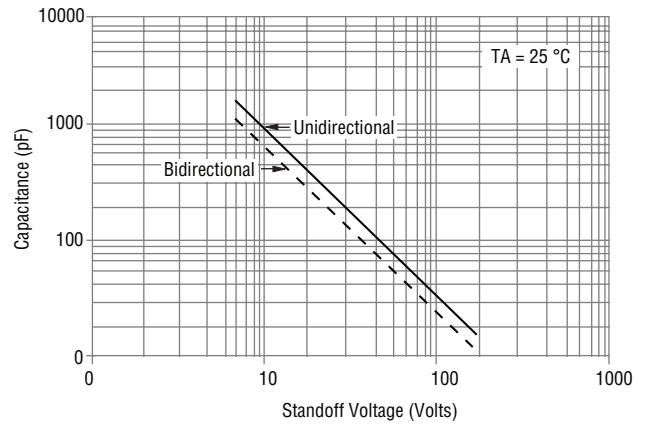

Pulse Rating Curve

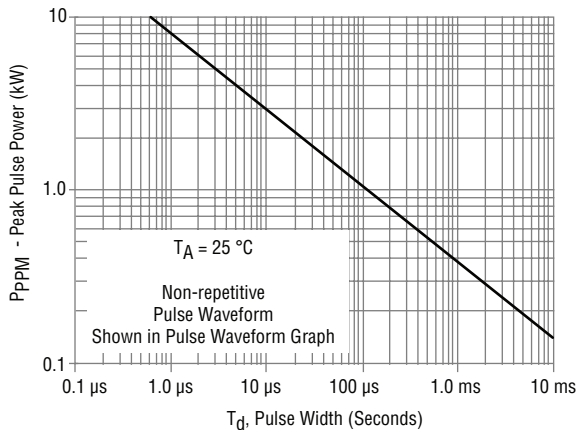

Steady State Power Derating Curve

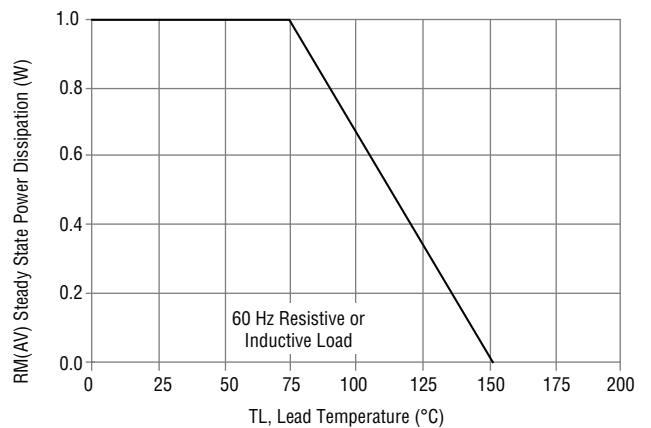

Specifications are subject to change without notice.

Users should verify actual device performance in their specific applications.

The products described herein and this document are subject to specific legal disclaimers as set forth on the last page of this document, and at www.bourns.com/docs/legal/disclaimer.pdf.

SMAJ Transient Voltage Suppressor Diode Series

BOURNS®

Packaging Information

The product will be dispensed in tape and reel format (see diagram below).

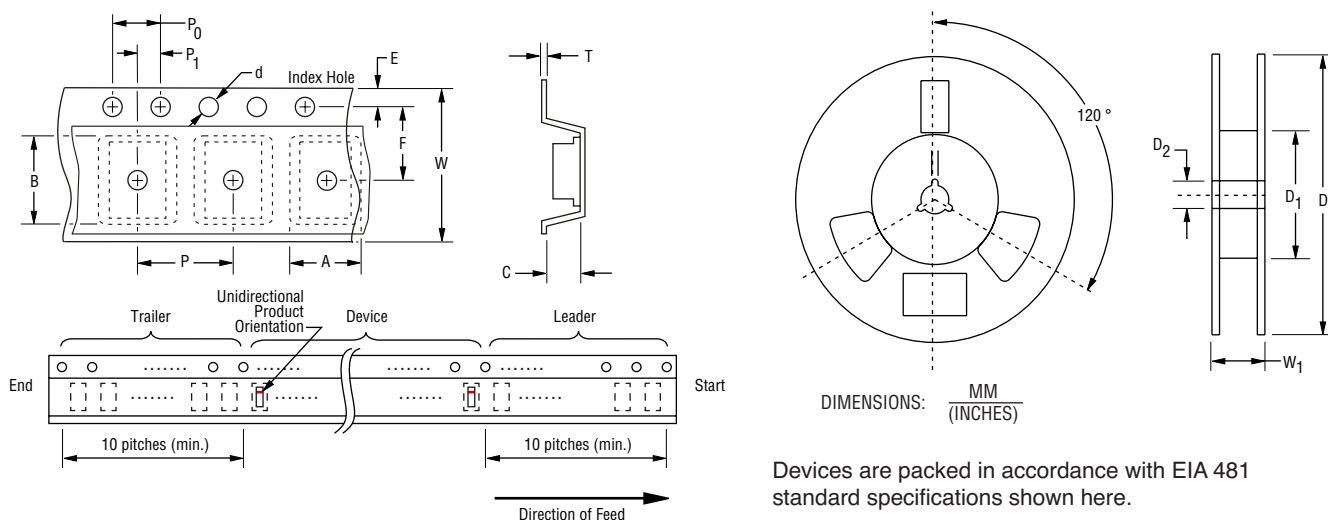

Devices are packed in accordance with EIA 481 standard specifications shown here.

Item	Symbol	SMA (DO-214AC)	
		7 Inch Reel	13 Inch Reel
Carrier Width	A	$\frac{2.90 \pm 0.20}{(0.114 \pm 0.008)}$	
Carrier Length	B	$\frac{5.50 \pm 0.20}{(0.217 \pm 0.008)}$	
Carrier Depth	C	$\frac{2.26 \pm 0.20}{(0.089 \pm 0.008)}$	
Sprocket Hole	d	$\frac{1.50 \pm 0.10}{(0.061 \pm 0.004)}$	
Reel Outside Diameter	D	$\frac{178}{(7.008)}$	$\frac{330}{(12.992)}$
Reel Inner Diameter	D ₁	$\frac{50.0}{(1.969)}$ MIN.	
Feed Hole Diameter	D ₂	$\frac{13.0 \pm 0.20}{(0.512 \pm 0.008)}$	
Sprocket Hole Position	E	$\frac{1.75 \pm 0.10}{(0.069 \pm 0.004)}$	
Punch Hole Position	F	$\frac{5.50 \pm 0.05}{(0.217 \pm 0.002)}$	
Punch Hole Pitch	P	$\frac{4.00 \pm 0.10}{(0.157 \pm 0.004)}$	
Sprocket Hole Pitch	P ₀	$\frac{4.00 \pm 0.10}{(0.157 \pm 0.004)}$	
Embossment Center	P ₁	$\frac{2.00 \pm 0.05}{(0.079 \pm 0.002)}$	
Overall Tape Thickness	T	$\frac{0.30 \pm 0.10}{(0.012 \pm 0.004)}$	
Tape Width	W	$\frac{12.00 \pm 0.30}{(0.472 \pm 0.012)}$	
Reel Width	W ₁	$\frac{18.4}{(0.724)}$ MAX.	
Quantity per Reel	--	1,000	5,000

REV. 08/20

Specifications are subject to change without notice.

Users should verify actual device performance in their specific applications.

The products described herein and this document are subject to specific legal disclaimers as set forth on the last page of this document, and at www.bourns.com/docs/legal/disclaimer.pdf.

This legal disclaimer applies to purchasers and users of Bourns® products manufactured by or on behalf of Bourns, Inc. and its affiliates (collectively, "Bourns").

Unless otherwise expressly indicated in writing, Bourns® products and data sheets relating thereto are subject to change without notice. Users should check for and obtain the latest relevant information and verify that such information is current and complete before placing orders for Bourns® products.

The characteristics and parameters of a Bourns® product set forth in its data sheet are based on laboratory conditions, and statements regarding the suitability of products for certain types of applications are based on Bourns' knowledge of typical requirements in generic applications. The characteristics and parameters of a Bourns® product in a user application may vary from the data sheet characteristics and parameters due to (i) the combination of the Bourns® product with other components in the user's application, or (ii) the environment of the user application itself. The characteristics and parameters of a Bourns® product also can and do vary in different applications and actual performance may vary over time. Users should always verify the actual performance of the Bourns® product in their specific devices and applications, and make their own independent judgments regarding the amount of additional test margin to design into their device or application to compensate for differences between laboratory and real world conditions.

Unless Bourns has explicitly designated an individual Bourns® product as meeting the requirements of a particular industry standard (e.g., ISO/TS 16949) or a particular qualification (e.g., UL listed or recognized), Bourns is not responsible for any failure of an individual Bourns® product to meet the requirements of such industry standard or particular qualification. Users of Bourns® products are responsible for ensuring compliance with safety-related requirements and standards applicable to their devices or applications.

Bourns® products are not recommended, authorized or intended for use in nuclear, lifesaving, life-critical or life-sustaining applications, nor in any other applications where failure or malfunction may result in personal injury, death, or severe property or environmental damage. Unless expressly and specifically approved in writing by two authorized Bourns representatives on a case-by-case basis, use of any Bourns® products in such unauthorized applications might not be safe and thus is at the user's sole risk. Life-critical applications include devices identified by the U.S. Food and Drug Administration as Class III devices and generally equivalent classifications outside of the United States.

Bourns expressly identifies those Bourns® standard products that are suitable for use in automotive applications on such products' data sheets in the section entitled "Applications." Unless expressly and specifically approved in writing by two authorized Bourns representatives on a case-by-case basis, use of any other Bourns® standard products in an automotive application might not be safe and thus is not recommended, authorized or intended and is at the user's sole risk. If Bourns expressly identifies a sub-category of automotive application in the data sheet for its standard products (such as infotainment or lighting), such identification means that Bourns has reviewed its standard product and has determined that if such Bourns® standard product is considered for potential use in automotive applications, it should only be used in such sub-category of automotive applications. Any reference to Bourns® standard product in the data sheet as compliant with the AEC-Q standard or "automotive grade" does not by itself mean that Bourns has approved such product for use in an automotive application.

Bourns® standard products are not tested to comply with United States Federal Aviation Administration standards generally or any other generally equivalent governmental organization standard applicable to products designed or manufactured for use in aircraft or space applications. Bourns expressly identifies Bourns® standard products that are suitable for use in aircraft or space applications on such products' data sheets in the section entitled "Applications." Unless expressly and specifically approved in writing by two authorized Bourns representatives on a case-by-case basis, use of any other Bourns® standard product in an aircraft or space application might not be safe and thus is not recommended, authorized or intended and is at the user's sole risk.

The use and level of testing applicable to Bourns® custom products shall be negotiated on a case-by-case basis by Bourns and the user for which such Bourns® custom products are specially designed. Absent a written agreement between Bourns and the user regarding the use and level of such testing, the above provisions applicable to Bourns® standard products shall also apply to such Bourns® custom products.

Users shall not sell, transfer, export or re-export any Bourns® products or technology for use in activities which involve the design, development, production, use or stockpiling of nuclear, chemical or biological weapons or missiles, nor shall they use Bourns® products or technology in any facility which engages in activities relating to such devices. The foregoing restrictions apply to all uses and applications that violate national or international prohibitions, including embargos or international regulations. Further, Bourns® products and Bourns technology and technical data may not under any circumstance be exported or re-exported to countries subject to international sanctions or embargoes. Bourns® products may not, without prior authorization from Bourns and/or the U.S. Government, be resold, transferred, or re-exported to any party not eligible to receive U.S. commodities, software, and technical data.

To the maximum extent permitted by applicable law, Bourns disclaims (i) any and all liability for special, punitive, consequential, incidental or indirect damages or lost revenues or lost profits, and (ii) any and all implied warranties, including implied warranties of fitness for particular purpose, non-infringement and merchantability.

For your convenience, copies of this Legal Disclaimer Notice with German, Spanish, Japanese, Traditional Chinese and Simplified Chinese bilingual versions are available at:

Web Page: <http://www.bourns.com/legal/disclaimers-terms-and-policies>

PDF: <http://www.bourns.com/docs/Legal/disclaimer.pdf>