

97

97 Crimp System Pliers with exchangeable crimp profiles



97 43 200
with crimp profile 97 49 06



Model 97 43 200:

- ▶ Crimp System Pliers 97 43 200 with service tools (hexagonal key, open end wrench, screws and nuts) in a plastic case. Foam insert with recesses for crimp profiles and locators.

Model 97 43 05/06:

- ▶ with fixed crimp profile; in cardboard packaging

- ▶ for solder-free electrical connections
- ▶ almost parallel crimping performance
- ▶ repetitive, high crimping quality due to precision dies and integral lock (self-releasing mechanism)
- ▶ these tools have been set precisely (calibrated) in the factory
- ▶ optimum transmission of force due to lever action for fatigue-reduced operation
- ▶ ergonomically designed handles
- ▶ wide range of different crimp profiles for nearly all common crimp connections (see Art. No. 97 49..)
- ▶ further special profiles on request
- ▶ different locators for precise positioning of the connectors
- ▶ all stressed parts are made of special steel, oil-hardened and tempered
- ▶ head burnished; with plastic handles



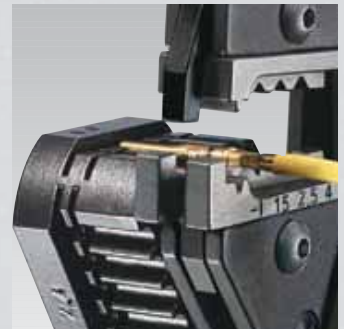

KNIPEX
special

Nearly all common crimp connections can be realized with the KNIPEX Crimp System Pliers simply by exchanging the crimping dies. This comfort represents hand crimping technology at the state-of-the-art and optimum crimping results.



Crimp System Pliers 97 43 200 with crimp profile 97 49 61 and locator 97 49 90 for turned contacts with different pin diameters, swivelling

97 43 200

Article-No.	EAN-Code	Range of applications	Capacity		Length	
			mm ²	AWG	mm	g
97 43 200	030812	see crimp die profile table			200	970
97 43 05	031031	  Crimp System Pliers for non-insulated 0.5 - 6.0 open plug-type connectors (plug width 4.8 + 6.3 mm)	20 - 10		200	615
97 43 06	031048	  Crimp System Pliers for insulated terminals and plug connectors	0.5 - 6.0	20 - 10	200	615



Crimp System Pliers 97 43 200 with crimp profile 97 49 30 for non-insulated butt connectors





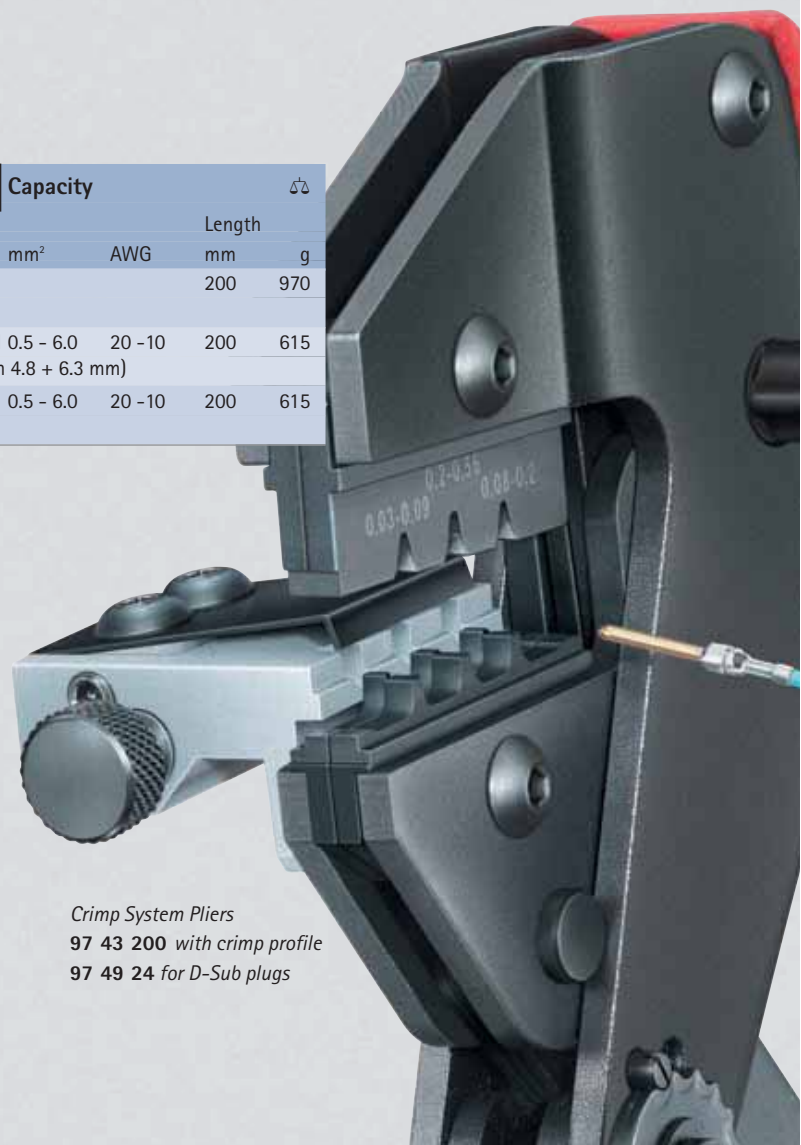









Crimp System Pliers 97 43 200 with crimp profile 97 49 35 for spark plug connectors



Crimp System Pliers 97 43 200 with crimp profile 97 49 24 for D-Sub plugs

97 Crimp Profiles and Locators for Crimp System Pliers

Crimp die profile	Article-No.	EAN-Code	Applications	Capacity	g	
		4003773-		AWG	g	
	97 49 04	030850	non-insulated open plug-type connectors	0.1 - 2.5 mm ²	27 - 13	50
	97 49 05	030867	(2.8 + 4.8 mm / 4.8 + 6.3 mm)	0.5 - 6.0 mm ²	20 - 10	55
	97 49 06	030836	insulated terminals and plug connectors	0.5 - 6.0 mm ²	20 - 10	55
	97 49 16	040675	insulated terminals and plug connectors	10/16 mm ²	7/5	50
	97 49 08	030874	end sleeves (ferrules)	0.25 - 6.0 mm ²	23 - 10	55
	97 49 09	030881	end sleeves (ferrules)	10/16/25 mm ²	7/5/3	55
	97 49 18	063186	twin end sleeves (ferrules) for flexible conductors	2 x 6/10/16 mm ²	10/7/5	65
	97 49 19	030898	end sleeves (ferrules)	35/50 mm ²	2/0	65
	97 49 13	030843	non-insulated terminals and plug connectors	0.5 - 10 mm ²	20 - 7	55
	97 49 23	052135	non-insulated terminals and plug connectors	16 + 25 mm ²	5 + 3	55
	97 49 15	043164	lug connectors and non-insulated plug connectors 4.8 + 6.3 mm	1.25 - 2.5 mm ²	17 - 13	55
	97 49 20	045069	F-connectors for TV and satellite connectors	∅ 9.6/SW 8.4 + 8.1 mm; ∅ 7.8/SW 7.0 mm		55
	97 49 24	030911	D-Sub-plugs	0.03 - 0.56 mm ²	32 - 20	45
	97 49 30	030904	non-insulated butt connectors	1.5 - 10 mm ²	15 - 7	55
	97 49 35	034315	spark plug connectors + distributors	1.0 mm ²	17	55
	97 49 40	030959	Coax connectors	RG 58, 59, 62, 71, 223		60
	97 49 50	030966	Coax connectors/Car phone	RG 58, 174, 188, 316		60
	97 49 44	041443	rolled contacts	0.14 - 1.5 mm ²	26 - 15	50
	97 49 54	041450	modular plugs	0.5 - 2.5 mm ²	20 - 13	55
	97 49 60	030928	turned contacts (HTS + Harting)	0.14 - 4.0 mm ²	26 - 11	55
	97 49 62	063179	solar connectors (Hubert + Suhner)	2.5/4.0 mm ²	13/11	60
	97 49 64	044093	ABS connectors	1.0 - 6.0 mm ²	17 - 10	60
	97 49 70	030942	unshielded Western plugs	4/6/8-poles RJ 10. 11. 12. 45		60
	97 49 74	044062	unshielded Molex plugs	8-poles RJ 12/RJ 45		55
	97 49 76	047513	shielded Stewart plugs			50
	97 49 81	042778	Harting connectors for fibre optics	SW 3.0/∅ 3.5; SW 4.95/∅ 6.0; SW 6.5/∅ 7.5		55
	97 49 82	042785	Telegärtner connectors for fibre optics	SW 3.25/∅ 3.6; SW 3.65/∅ 4.0; SW 4.52/∅ 5.4		55
	97 49 83	044079	LWL-ST-, SC- + STSC-K-plugs for fibre optics	SW 3.65/∅ 4.1; SW 4.2/∅ 4.6; SW 5.0/∅ 6.0		55
	97 49 84	042792	Harting/Suhner connectors for fibre optics	SW 3.8/∅ 4.5; SW 4.3/∅ 5.2; SW 4.95/∅ 6.0		55
	97 49 87	043331	F-SMA; ST and MIC connectors for fibre optics	SW 8.7/∅ 9.5		50
	97 49 90	031017	Locator for 97 49 60 (HTS + Harting)			70
	97 49 91	045144	Locator for 97 49 61 (Harting)			70
	97 49 93	047926	Locator for 97 49 24 (D-Sub-plugs)			70
	97 49 94	030997	Locator for 97 49 04			20
	97 49 95	031000	Locator for 97 49 05			20