

ESY, Aluminum Electrolytic, 1,000 uF, 20%, 16 VDC, -40/+105°C, Lead Spacing = 5mm

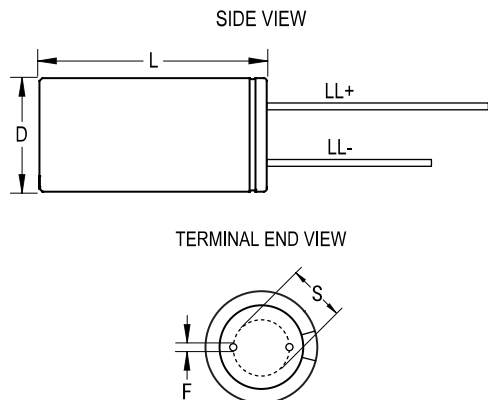

General Information	
Supplier:	KEMET
Series:	ESY
Dielectric:	Aluminum Electrolytic
Description:	LowZ Single Ended Aluminum Electrolytic
Features:	Low Z
RoHS:	Yes
Lead:	Wire Leads
AEC-Q200:	No

Dimensions	
D	10mm +/-0.5mm
L	20mm +2mm
S	5mm +/-0.5mm
LL Negative	15mm MIN
LL Positive	20mm MIN
F	0.6mm NOM

Specifications	
Capacitance:	1,000 uF
Capacitance Tolerance:	20%
Voltage DC:	16 VDC, 20 VDC (Surge)
Temperature Range:	-40/+105°C
Rated Temperature:	105°C
Life:	4000 Hrs
Dissipation Factor:	16.00%
Resistance:	0.026 Ohms (100kHz)
Ripple Current:	1820 mAmps (100kHz 105C)
Leakage Current:	160 uA (2min 20°C)
Impedance Ratio at -25C:	2
Impedance Ratio at -40C:	3

Packaging Specifications	
Packaging:	Bulk, Bag
Packaging Quantity:	2400

Statements of suitability for certain applications are based on our knowledge of typical operating conditions for such applications, but are not intended to constitute - and we specifically disclaim - any warranty concerning suitability for a specific customer application or use. This Information is intended for use only by customers who have the requisite experience and capability to determine the correct products for their application. Any technical advice inferred from this Information or otherwise provided by us with reference to the use of our products is given gratis, and we assume no obligation or liability for the advice given or results obtained.