



Part no.: 50141120
DDLS 538 120.3 L H S2
Optical data transmission



EtherCAT



Figure can vary

Contents

- Technical data
- Dimensioned drawings
- Electrical connection
- Operation and display
- Suitable transmitters
- Part number code
- Notes
- Accessories

Technical data

Basic data	
Series	DDLS 500
Special design	
Special design	Heating Integrated laser alignment aid Not influenced by reflective surfaces Operation of parallel light axes
Optical data	
Working range	100 ... 120,000 mm
Light source	Laser
Usable opening angle transmitter	1 °
Electrical data	
Performance data	
Supply voltage U_B	18 ... 30 V , DC
Inputs	
Number of digital switching inputs	1 Piece(s)
Outputs	
Number of digital switching outputs	1 Piece(s)
Interface	
Type	EtherCAT
EtherCAT	
Transmission speed	100 Mbit/s
Connection	
Number of connections	2 Piece(s)
Connection 1	
Type of connection	Connector
Designation on device	POWER
Thread size	M12
Type	Male
No. of pins	5 -pin
Encoding	A-coded
Connection 2	
Type of connection	Connector
Designation on device	BUS
Thread size	M12
Type	Female
No. of pins	4 -pin
Encoding	D-coded
Mechanical data	
Dimension (W x H x L)	100 mm x 156 mm x 99.5 mm
Housing material	Metal
Net weight	1,185 g

Operation and display

Type of display	Bar graph LED
-----------------	------------------

Environmental data

Ambient temperature, operation	-35 ... 50 °C
Ambient temperature, storage	-35 ... 70 °C

Certifications

Degree of protection	IP 65
Certifications	c UL US
Test procedure for EMC in accordance with standard	EN 1000-6-4 EN 61000-6-2
Test procedure for noise in accordance with standard	EN 60068-2-64
Test procedure for oscillation in accordance with standard	EN 60068-2-6
Test procedure for shock in accordance with standard	EN 60068-2-27

Classification

Customs tariff number	85365019
eCl@ss 8.0	19179090
eCl@ss 9.0	19179090
ETIM 5.0	EC000515
ETIM 6.0	EC000515

Dimensioned drawings

All dimensions in millimeters

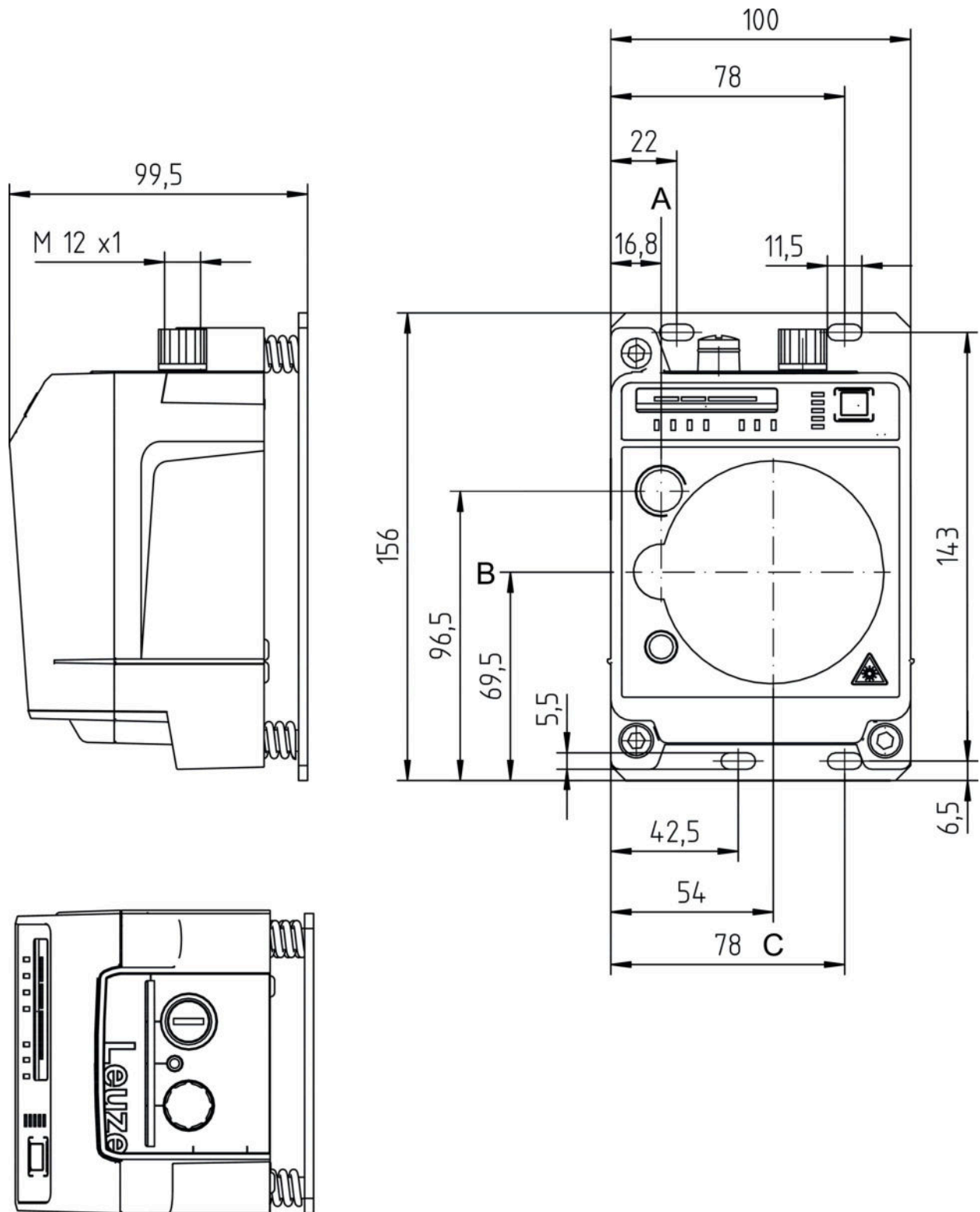

A Center axis of transmitter and alignment laser
 B Center axis of transmitter and receiver
 C Center axis of receiver

Electrical connection

Connection 1	POWER
Function	Signal IN Signal OUT Voltage supply
Type of connection	Connector
Thread size	M12
Type	Male
Material	Metal
No. of pins	5 -pin
Encoding	A-coded

Pin	Pin assignment
1	VIN
2	IO1
3	GND
4	IO2
5	FE/SHIELD

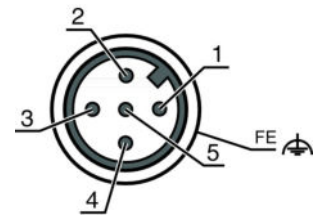

Connection 2	BUS
Function	BUS IN
Type of connection	Connector
Thread size	M12
Type	Female
Material	Metal
No. of pins	4 -pin
Encoding	D-coded

Pin	Pin assignment
1	TD+
2	RD+
3	TD-
4	RD-

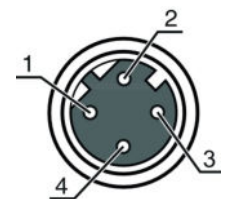

Operation and display

LEDs

LED	Display	Meaning	
1	AUT	Off	Operating mode not active
		Green, continuous light	Operating mode 'Automatic'
2	MAN	Off	Operating mode not active
		Green, continuous light	Operating mode 'Manual'
3	ADJ	Off	Operating mode not active
		Green, continuous light	Operating mode 'Adjust'
4	LAS	Off	Operating mode not active
		Green, continuous light	Operating mode 'Alignment-laser mounting support'

LED	Display	Meaning	
5	LLC	Off	Operating mode not active
		Green, continuous light	LLC without interruption
		Red, continuous light	LLC interrupted at least once
6	PWR	Off	No supply voltage
		Green, flashing	Device ok, initialization phase
		Green, continuous light	Data transmission active
		Red, flashing	Data transmission interrupted
		Red, continuous light	Device error
7	TMP	Off	Operating temperature OK
		Orange, continuous light	Operating temperature critical
		Red, continuous light	Operating temperature exceeded or not met
8	LSR	Off	With function reserve
		Orange, continuous light	Device OK, warning set
9	MAS	Off	Installation on slave side
		Green, continuous light	Installation on master side
10	OLK	Off	Fault
		Green, continuous light	No data transmission
		Orange, continuous light	Data transmission active
11	ERL	Off	Link OK
		Orange, continuous light	Missing link (Ethernet cable connection) on the second device
		Red, continuous light	No cable-connected link to the connected device
12	LINK	Off	No cable-connected link to the connected device
		Green, continuous light	Link OK
		Orange, continuous light	Data transmission active
13	SIGNAL QUALITY	2 red, 2 orange and 4 green	Received signal level

Suitable transmitters

	Part no.	Designation	Article	Description
	50141121	DDLS 538 120.4 L H S2	Optical data transmission	Working range: 100 ... 120,000 mm Interface: Ethernet Connection: Connector, M12 Special design: Integrated laser alignment aid, Heating, Not influenced by reflective surfaces, Operation of parallel light axes

Part number code

Part designation: **DDLS 5XXX YYY.Z A B CC**

DDLS	Optical transceiver for digital data transmission
5XXX	Series: 508i: without integrated web server for remote diagnostics 508i: with integrated web server for remote diagnostics 538: without integrated web server for remote diagnostics (EtherCAT) 548i: with integrated web server for remote diagnostics
YYY	Range for data transmission in m
Z	Frequency of the transmitter: 0: Frequency F0 1: Frequency F1 2: Frequency F2 3: Frequency F3 4: Frequency F4

Part no.: 50141120 – DDLS 538 120.3 L H S2 – Optical data transmission

A	Option: L: integrated laser alignment aid (for transmitter/receiver) n/a: standard
B	Special equipment: H: with heating n/a: no special equipment
CC	Special equipment: S2: Optimized for EtherCAT transmission n/a: no special equipment

Note

A list with all available device types can be found on the Leuze electronic website at www.leuze.com.

Notes

Observe intended use!

- This product is not a safety sensor and is not intended as personnel protection.
- The product may only be put into operation by competent persons.
- Only use the product in accordance with its intended use.

For UL applications:

- For UL applications, use is only permitted in Class 2 circuits in accordance with the NEC (National Electric Code).

WARNING! LASER RADIATION – CLASS 1 LASER PRODUCT (alignment laser)

The device satisfies the requirements of IEC 60825-1:2007 (EN 60825-1:2007) safety regulations for a product of **laser class 1** as well as the U.S. 21 CFR 1040.10 regulations with deviations corresponding to "Laser Notice No. 50" from June 24, 2007.

- The device satisfies the requirements of IEC 60825-1:2007 (EN 60825-1:2007) safety regulations for a product of **laser class 1** as well as the U.S. 21 CFR 1040.10 regulations with deviations corresponding to "Laser Notice No. 50" from June 24, 2007.
- Observe the applicable statutory and local laser protection regulations.

Accessories

Connection technology - Connection cables

	Part no.	Designation	Article	Description
	50132079	KD U-M12-5A-V1-050	Connection cable	Connection 1: Connector, M12, Axial, Female, A-coded, 5 -pin Connection 2: Open end Shielded: No Cable length: 5,000 mm Sheathing material: PVC



Part no.: 50141120 – DDLS 538 120.3 L H S2 – Optical data transmission

	Part no.	Designation	Article	Description
	50135074	KS ET-M12-4A-P7-050	Connection cable	Suitable for interface: Ethernet Connection 1: Connector, M12, Axial, Male, D-coded, 4 -pin Connection 2: Open end Shielded: Yes Cable length: 5,000 mm Sheathing material: PUR

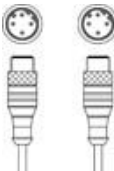
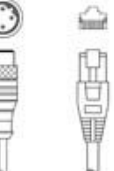

Connection technology - Interconnection cables

	Part no.	Designation	Article	Description
	50137078	KSS ET-M12-4A-M12-4A-P7-050	Interconnection cable	Suitable for interface: Ethernet Connection 1: Connector, M12, Axial, Male, D-coded, 4 -pin Connection 2: Connector, M12, Axial, Male, D-coded, 4 -pin Shielded: Yes Cable length: 1,000 mm Sheathing material: PUR
	50135081	KSS ET-M12-4A-RJ45-A-P7-050	Interconnection cable	Suitable for interface: Ethernet Connection 1: Connector, M12, Axial, Male, D-coded, 4 -pin Connection 2: RJ45 Shielded: Yes Cable length: 5,000 mm Sheathing material: PUR

Connection technology - Connectors

	Part no.	Designation	Article	Description
	50020501	KD 095-5A	Connector	Connection: Connector with screw terminals, M12, Axial, Female, A-coded, 5 -pin
	50112155	S-M12A-ET	Connector	Suitable for interface: Ethernet Connection: Connector, M12, Axial, Male, D-coded, 4 -pin

Services

	Part no.	Designation	Article	Description
	S981001	CS10-S-110	Start-up support	Details: Performed at location of customer's choosing, duration: max. 10 hours. Conditions: Devices and connection cables are already mounted, price not including travel costs and, if applicable, accommodation expenses. Restrictions: No mechanical (mounting) and electrical (wiring) work performed, no changes (attachments, wiring, programming) to third-party components in the nearby environment.
	S981005	CS10-T-110	Product training	Details: Location and content to be agreed upon, duration: max. 10 hours. Conditions: Price not including travel costs and, if applicable, accommodation expenses. Restrictions: Travel costs and accommodation expenses charged separately and according to expenditure.

Part no.: 50141120 – DDLS 538 120.3 L H S2 – Optical data transmission

Note

A list with all available accessories can be found on the Leuze electronic website in the Download tab of the article detailed page.