



UNDervOLTAGE RELEASE AC 24V, 50HZ/60HZ, W. LEADING AUX. SWITCHES, 2NO, FOR CIRCUIT-BREAKERS 3RV2

Figure similar

General technical data:		
product brand name		SIRIUS
Product designation		undervoltage release
Size of the circuit-breaker		S00, S0, S2
Design of the product		with 2 auxiliary contacts
Suitability for use		motor circuit breaker
Protection class IP on the front		IP20
Design of short-circuit protection		fuse
Degree of pollution		3
Insulation voltage Rated value	V	690
Insulation voltage with degree of pollution 3 Rated value	V	690
Ambient temperature		
• during storage	°C	-50 ... +80
• during operation	°C	-20 ... +60
Equipment marking acc. to DIN 40719 extended according to IEC 204-2 acc. to IEC 750		F
Equipment marking acc. to DIN EN 61346-2		F
Auxiliary circuit:		
Number of NC contacts for auxiliary contacts instantaneous contact		0
Number of NO contacts for auxiliary contacts instantaneous contact		0
Number of NO contacts for auxiliary contacts leading contact		2

Number of CO contacts of the auxiliary contacts instantaneous contact		0
---	--	---

Control circuit/ Control:

Type of voltage of the control supply voltage		AC
Control supply voltage frequency		
<ul style="list-style-type: none"> • 1 <ul style="list-style-type: none"> — Rated value — Initial rated value — Final rated value • 2 Rated value 	 	
Control supply voltage		
<ul style="list-style-type: none"> • 1 <ul style="list-style-type: none"> — for DC <ul style="list-style-type: none"> — Rated value — Initial rated value — Final rated value — with AC <ul style="list-style-type: none"> — at 50 Hz Rated value — at 50 Hz Initial rated value — at 50 Hz Final rated value — at 60 Hz Rated value — at 60 Hz Final rated value — at 60 Hz Initial rated value • 2 <ul style="list-style-type: none"> — for DC Rated value — with AC <ul style="list-style-type: none"> — at 50 Hz Rated value — at 60 Hz Rated value 	 	

Installation/ mounting/ dimensions:

Mounting type		snap-on mounting
Width	mm	18.5
Height	mm	90
Depth	mm	68
Required spacing with side-by-side mounting		
<ul style="list-style-type: none"> • forwards • Backwards • upwards • downwards • at the side 		
Required spacing for grounded parts		
<ul style="list-style-type: none"> • forwards 		<kein Wert>

- Backwards
- upwards
- at the side
- downwards

<kein Wert>
<kein Wert>
<kein Wert>
<kein Wert>

Required spacing for live parts





- forwards
- Backwards
- upwards
- downwards
- at the side

<kein Wert>
<kein Wert>
<kein Wert>
<kein Wert>
<kein Wert>

Certificates/ approvals:



Certificate of suitability

CE / UL / CSA

General Product Approval	Declaration of Conformity	Test Certificates		Shipping Approval
 CSA	 UL	 EG-Konf.	Special Test Certificate	Type Test Certificates/Test Report
				 ABS

Shipping Approval

 BUREAU VERITAS	 DNV	 GL	 LRS	 PRS	 RINA
---	--	---	--	--	---

Shipping Approval	other			
 RMRS	Confirmation	Environmental Confirmations	 VDE	other

Further information

Information- and Downloadcenter (Catalogs, Brochures,...)

<http://www.siemens.com/industrial-controls/catalogs>

Industry Mall (Online ordering system)

<http://www.siemens.com/industrymall>

Cax online generator

<http://support.automation.siemens.com/WW/CAXorder/default.aspx?lang=en&mfb=3RV29221CB0>

Service&Support (Manuals, Certificates, Characteristics, FAQs,...)

<http://support.automation.siemens.com/WW/view/en/3RV29221CB0/all>

Image database (product images, 2D dimension drawings, 3D models, device circuit diagrams, EPLAN macros, ...)

<http://www.automation.siemens.com/bilddb/index.aspx?attID9=3RV29221CB0&lang=en>

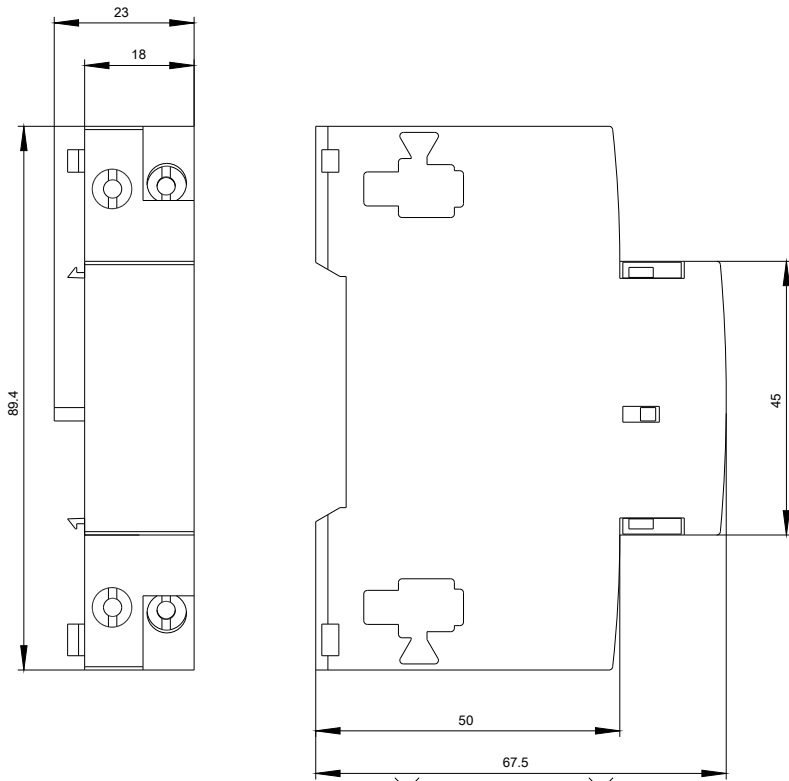

-F

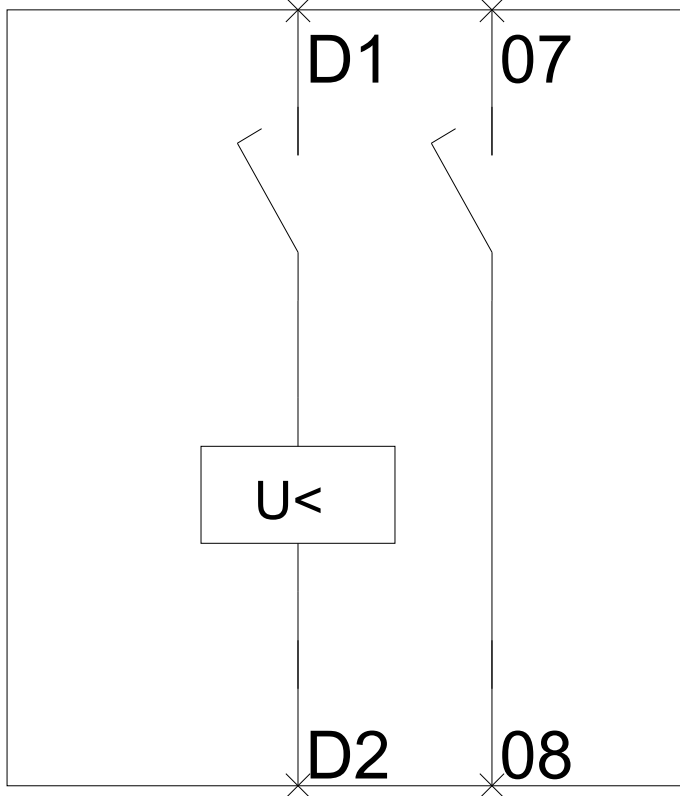

last modified:

09.03.2015