

DATA SHEET

METAL OXIDE VARISTORS POWER SUPPLY

14D series

RoHS compliant & Halogen free



Product specification— May 08, 2021 V.2



Metal Oxide Varistor (MOV) Data Sheet

Features

- Wide operating voltage (V_{1mA}) range from 18V to 1800V
- Fast responding to transient over-voltage
- Large absorbing transient energy capability
- Low clamping ratio and no follow-on current
- Meets MSL level 1, per J-STD-020
- Operating Temperature: $-40^{\circ}\text{C} \sim +105^{\circ}\text{C}$
- Storage Temperature: $-40^{\circ}\text{C} \sim +125^{\circ}\text{C}$
- Safety certification: UL、CSA、VDE



Applications

- Transistor, diode, IC, thyristor or triac semiconductor protection
- Surge protection in consumer electronics
- Surge protection in industrial electronics
- Surge protection in electronic home appliances, gas and petroleum appliances
- Relay and electromagnetic valve surge absorption

Part Number Code

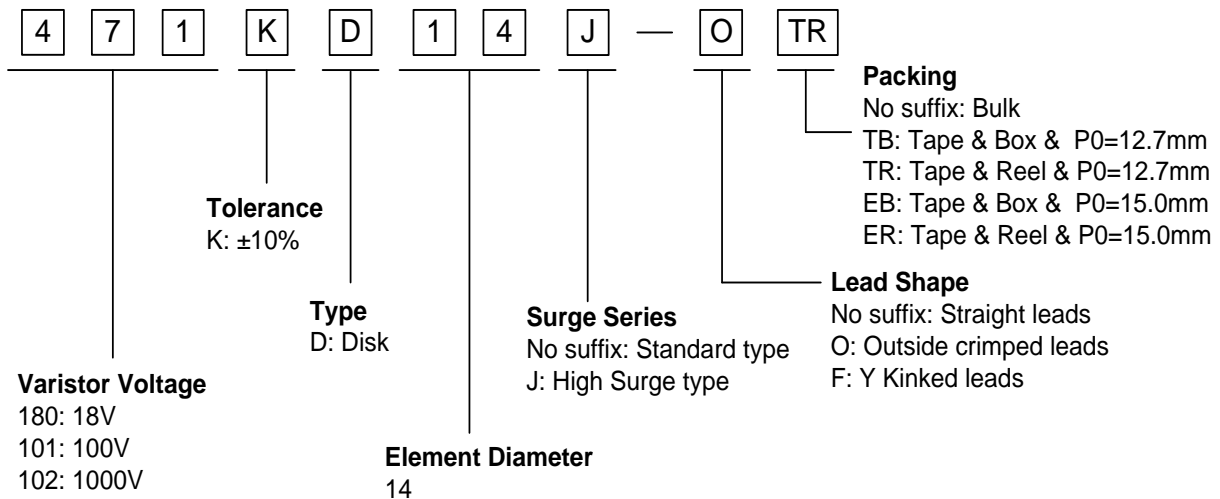

Dimensions

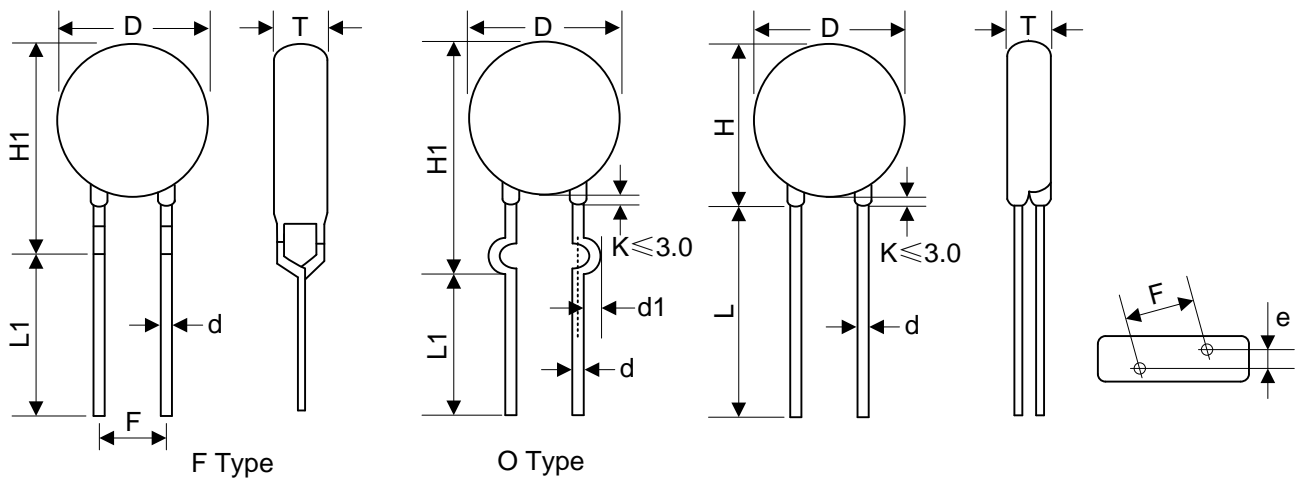

Notes: Varistor voltage ≥ 1200V, structure diagram is F type.

Table 1	
Unit: mm	
Symbol	Dimension
H	14.5~20.0
H1	17.0~21.0
L(min.)	20.0
L1(min.)	15.0
D	14.0~16.5
F(±0.8)	7.5
T	Table 2
e(±0.8)	Table 2
d(±0.05)	0.8
d1(±0.4)	1.4

Table 2					
Unit: mm					
Model	T	e	Model	T	e
180K	2.0~3.9	1.5	361K	2.9~5.2	2.7
220K	2.1~4.0	1.6	391K	3.0~5.4	2.8
270K	2.1~4.1	1.8	431K	3.2~5.6	3.0
330K	2.2~4.3	1.7	471K	3.3~5.8	3.2
390K	2.1~4.1	1.8	511K	3.4~6.1	3.4
470K	2.2~4.3	1.9	561K	3.6~6.4	3.6
560K	2.3~4.6	2.1	621K	3.8~6.8	3.9
680K	2.4~4.8	2.4	681K	4.0~7.1	4.2
820K	2.1~4.1	1.8	751K	4.3~7.2	4.3
101K	2.4~4.2	2.0	781K	4.4~7.3	4.4
121K	2.4~4.4	2.2	821K	4.6~7.5	4.6
151K	2.2~4.1	1.8	911K	4.8~7.5	5.0
181K	2.3~4.2	1.9	102K	5.4~8.0	5.0
201K	2.4~4.3	2.0	112K	5.8~8.5	5.4
221K	2.5~4.4	2.1	122K	5.9~9.0	5.8
241K	2.6~4.5	2.2	142	6.9~10.5	6.6
271K	2.6~4.6	2.4	162	7.4~11.0	7.4
301K	2.7~4.6	2.5	182	7.6~12.0	8.2
331K	2.7~5.0	2.5			

Electrical Characteristics

Part Number		Maximum Allowable Voltage		Varistor Voltage	Maximum Clamping Voltage		Withstanding Surge Current		Maximum Energy (10/1000 μ s)		Rated Power	Typical Capacitance (Reference)
Standard	High Surge	V _{AC} (V)	V _{DC} (V)	V _{1mA} (V)	I _P (A)	V _C (V)	I (A) Standard	I (A) High Surge	(J) Standard	(J) High Surge	(W)	@ 1KHz (pf)
180KD14	180KD14J	11	14	18(15~21.6)	10	36	1000	2000	4.0	7.0	0.1	11100
220KD14	220KD14J	14	18	22(19.5~26)	10	43	1000	2000	5.0	8.0	0.1	9100
270KD14	270KD14J	17	22	27(24~31)	10	53	1000	2000	6.0	10.0	0.1	7400
330KD14	330KD14J	20	26	33(29.5~36.5)	10	65	1000	2000	7.5	12.0	0.1	6100
390KD14	390KD14J	25	31	39(35~43)	10	77	1000	2000	8.6	13.0	0.1	5100
470KD14	470KD14J	30	38	47(42~52)	10	93	1000	2000	10.0	17.0	0.1	4300
560KD14	560KD14J	35	45	56(50~62)	10	110	1000	2000	11.0	20.0	0.1	3600
680KD14	680KD14J	40	56	68(61~75)	10	135	1000	2000	14.0	24.0	0.1	2900
820KD14	820KD14J	50	65	82(74~90)	50	135	4500	6000	22.0	27.0	0.6	2400
101KD14	101KD14J	60	85	100(90~110)	50	165	4500	6000	28.0	33.0	0.6	2000
121KD14	121KD14J	75	100	120(108~132)	50	200	4500	6000	32.0	40.0	0.6	1700
151KD14	151KD14J	95	125	150(135~165)	50	250	4500	6000	40.0	53.0	0.6	1300
181KD14	181KD14J	115	150	180(162~198)	50	300	4500	6000	50.0	60.0	0.6	1100
201KD14	201KD14J	130	170	200(180~220)	50	340	4500	6000	57.0	70.0	0.6	1000
221KD14	221KD14J	140	180	220(198~242)	50	360	4500	6000	60.0	78.0	0.6	900
241KD14	241KD14J	150	200	240(216~264)	50	395	4500	6000	63.0	84.0	0.6	830
271KD14	271KD14J	175	225	270(243~297)	50	455	4500	6000	70.0	99.0	0.6	740
301KD14	301KD14J	190	250	300(270~330)	50	500	4500	6000	77.0	108	0.6	670
331KD14	331KD14J	210	275	330(297~363)	50	550	4500	6000	85.0	115	0.6	610
361KD14	361KD14J	230	300	360(324~396)	50	595	4500	6000	93.0	130	0.6	560
391KD14	391KD14J	250	320	390(351~429)	50	650	4500	6000	100	140	0.6	510
431KD14	431KD14J	275	350	430(387~473)	50	710	4500	6000	115	155	0.6	460
471KD14	471KD14J	300	385	470(423~517)	50	775	4500	6000	118	175	0.6	430
511KD14	511KD14J	320	415	510(459~561)	50	845	4500	6000	121	180	0.6	390
561KD14	561KD14J	350	460	560(504~616)	50	925	4500	6000	125	185	0.6	360
621KD14	621KD14J	385	505	620(558~682)	50	1025	4500	6000	128	190	0.6	320
681KD14	681KD14J	420	560	680(612~748)	50	1120	4500	6000	130	200	0.6	290
751KD14	751KD14J	460	615	750(675~825)	50	1240	4500	6000	143	210	0.6	270
781KD14	781KD14J	485	640	780(702~858)	50	1290	4500	6000	148	220	0.6	260
821KD14	821KD14J	510	670	820(738~902)	50	1355	4500	6000	157	235	0.6	240
911KD14	911KD14J	550	745	910(819~1001)	50	1500	4500	6000	175	255	0.6	220
102KD14	102KD14J	625	825	1000(900~1100)	50	1650	4500	6000	190	280	0.6	200
112KD14	112KD14J	680	895	1100(990~1210)	50	1815	4500	6000	213	310	0.6	180
122KD14	122KD14J	750	990	1200(1080~1320)	50	1980	4500	6000	232	324	0.6	160
142KD14	/	880	1140	1400(1260~1540)	50	2310	4500	/	238	/	0.6	150
162KD14	/	1000	1280	1600(1440~1760)	50	2640	4500	/	243	/	0.6	140
182KD14	/	1100	1465	1800(1620~1980)	50	2970	4500	/	250	/	0.6	130

- Notes: 1. The tolerance of varistor voltage between 18V and 27V is more than 10%;
2. Varistor voltage $\geq 1200V$, structure diagram is F type;
3. Leakage Current (@83% of V_{1mA}): IR $\leq 50\mu A$ (180K~680K) ; IR $\leq 25\mu A$ (820K~182K).

Maximum Surge Current Derating Curve

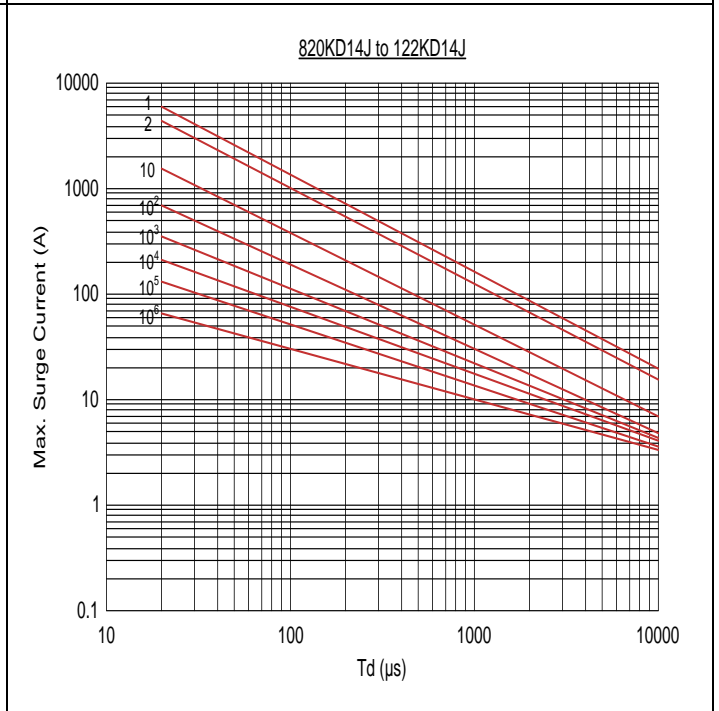
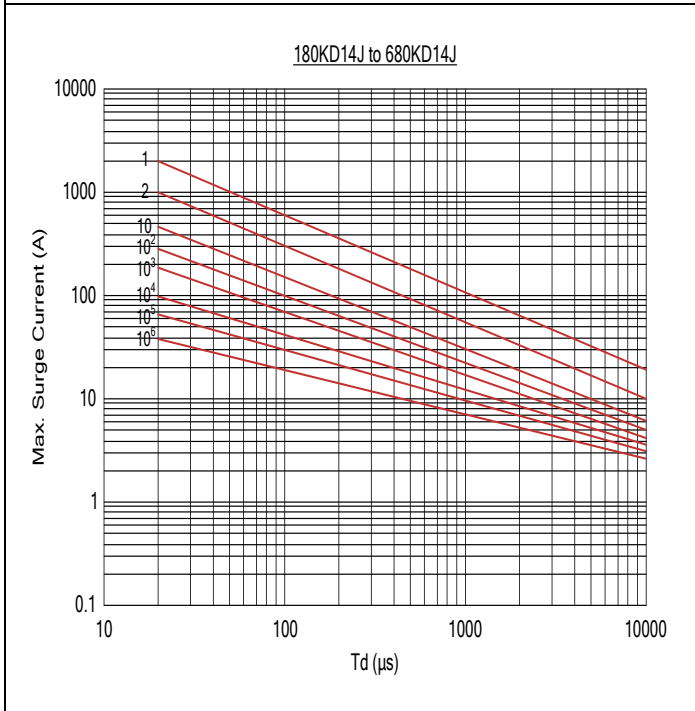
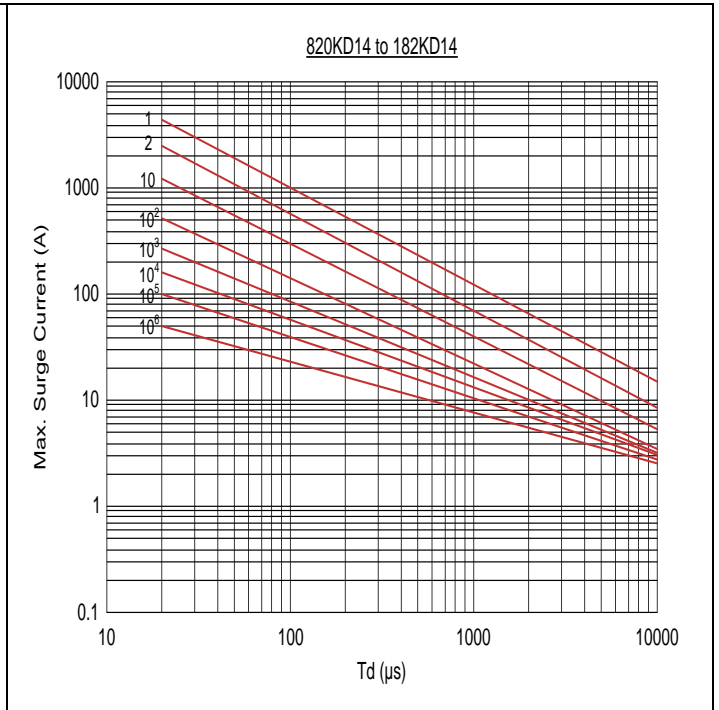
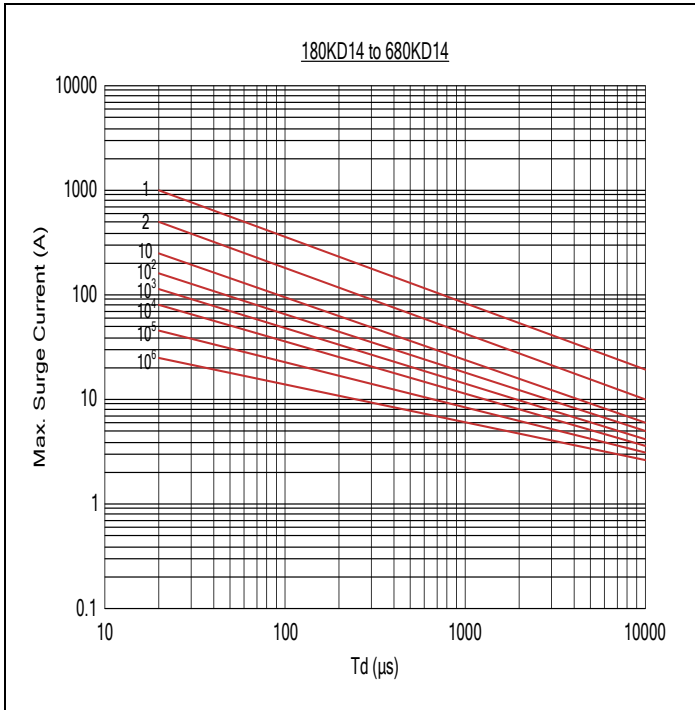

Maximum Leakage Current and Maximum Clamping Voltage Curve

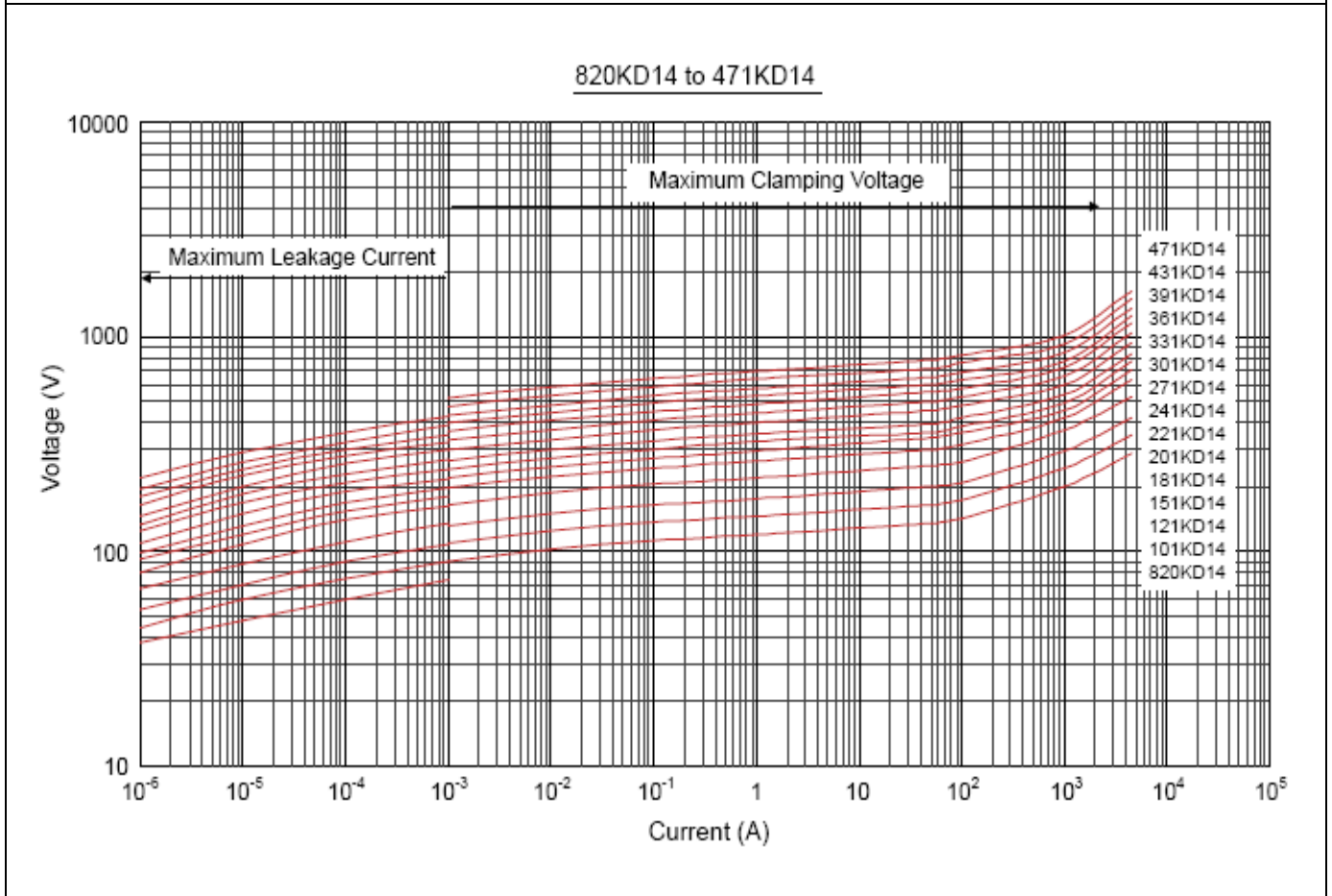
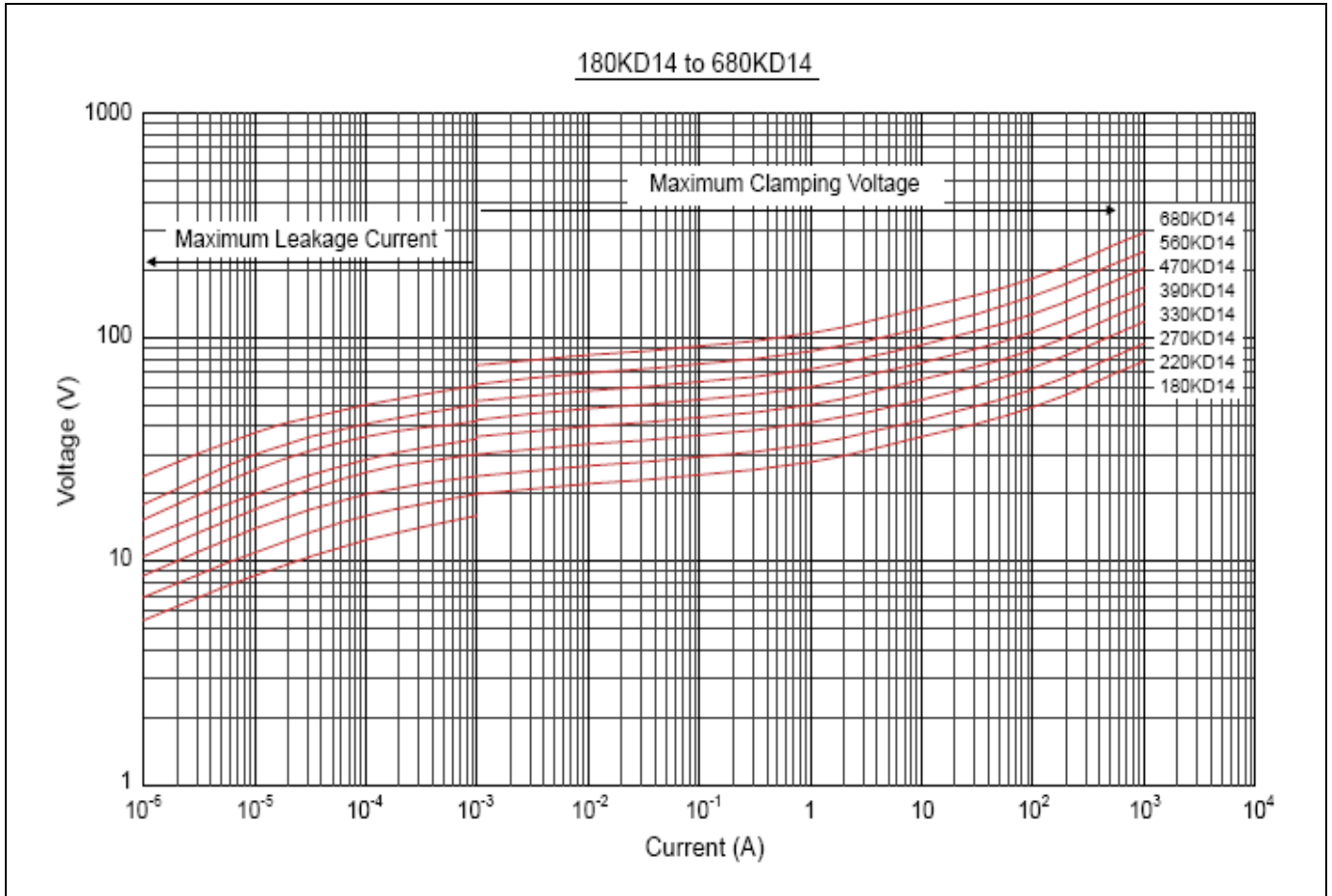

Maximum Leakage Current and Maximum Clamping Voltage Curve

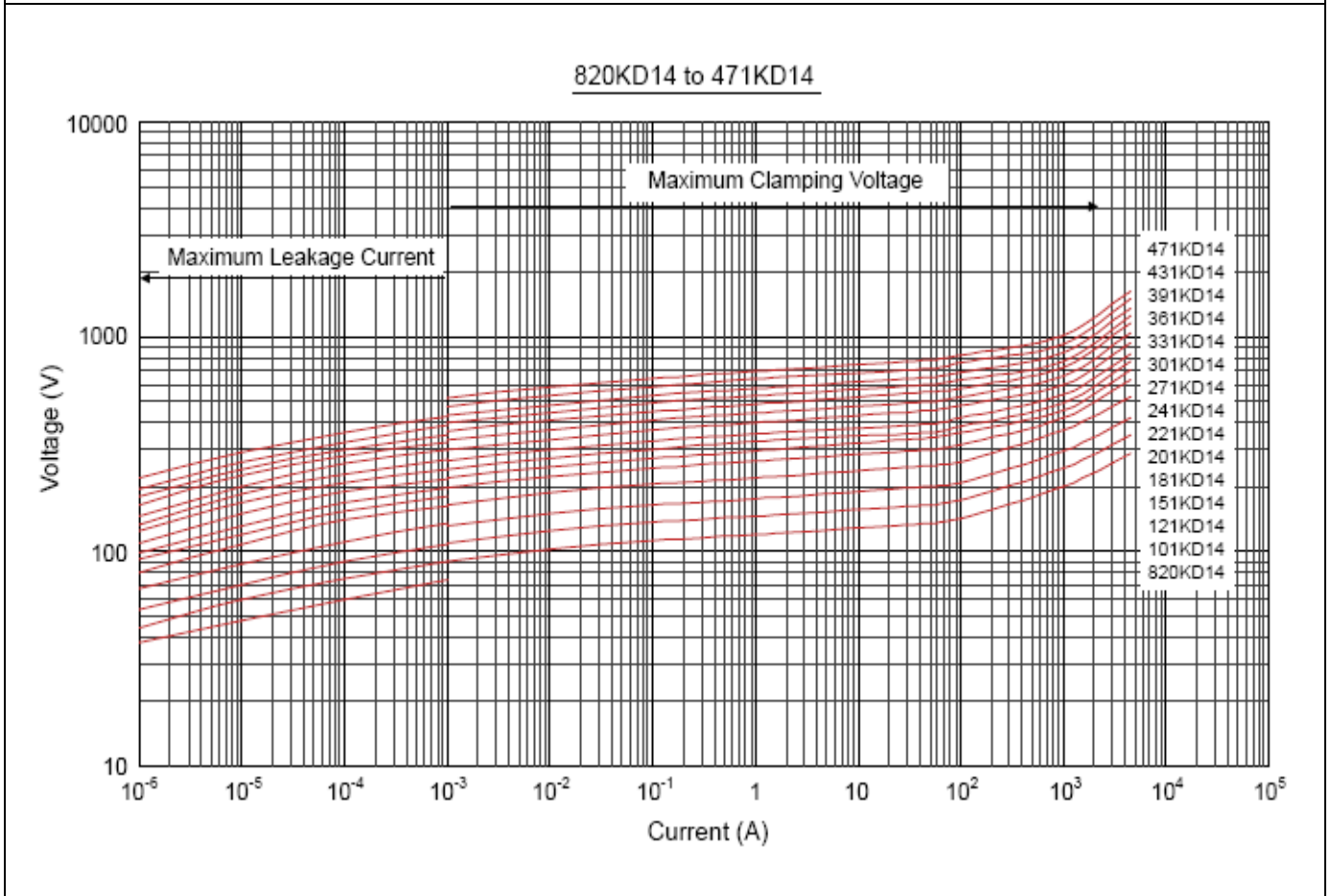
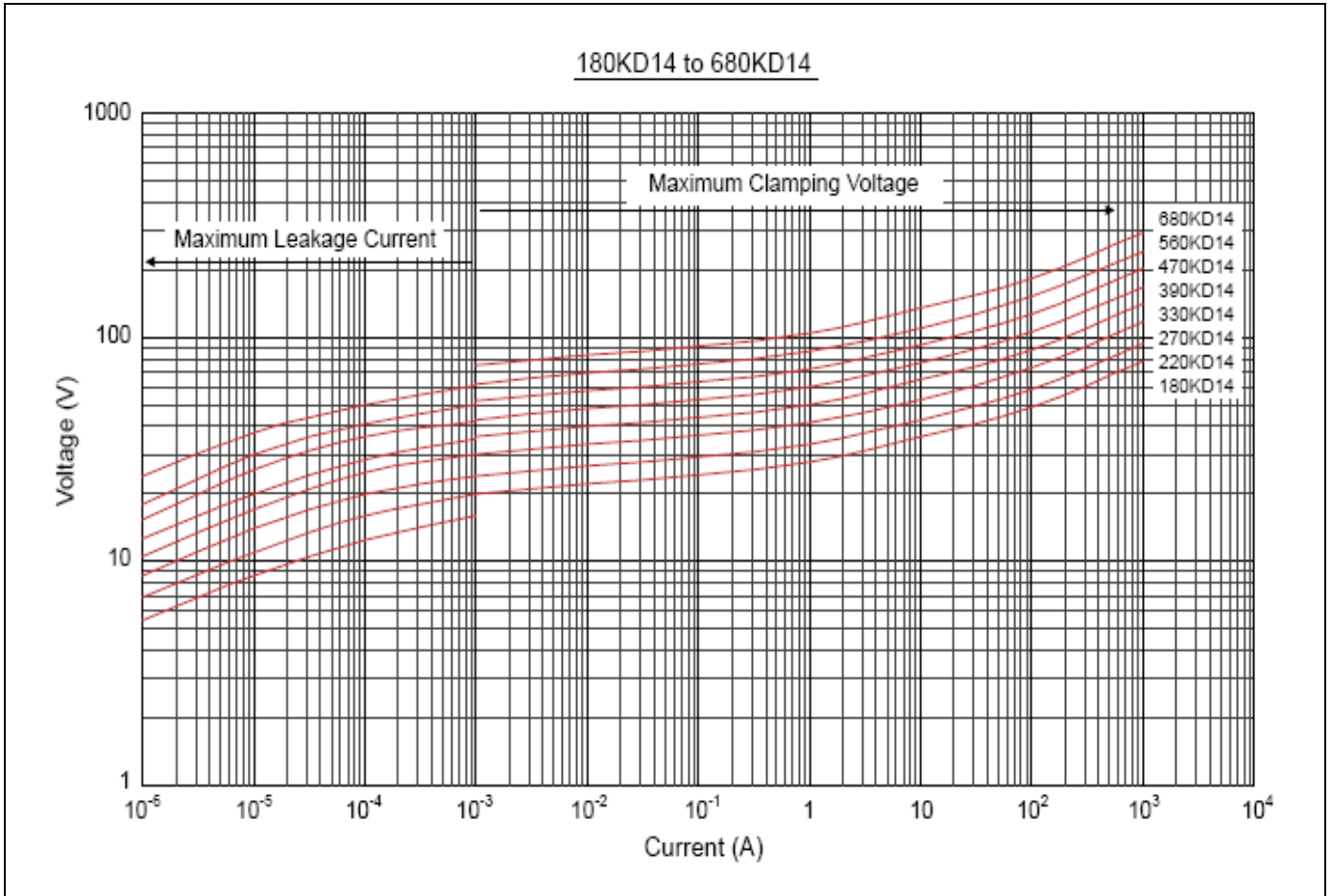

Maximum Leakage Current and Maximum Clamping Voltage Curve

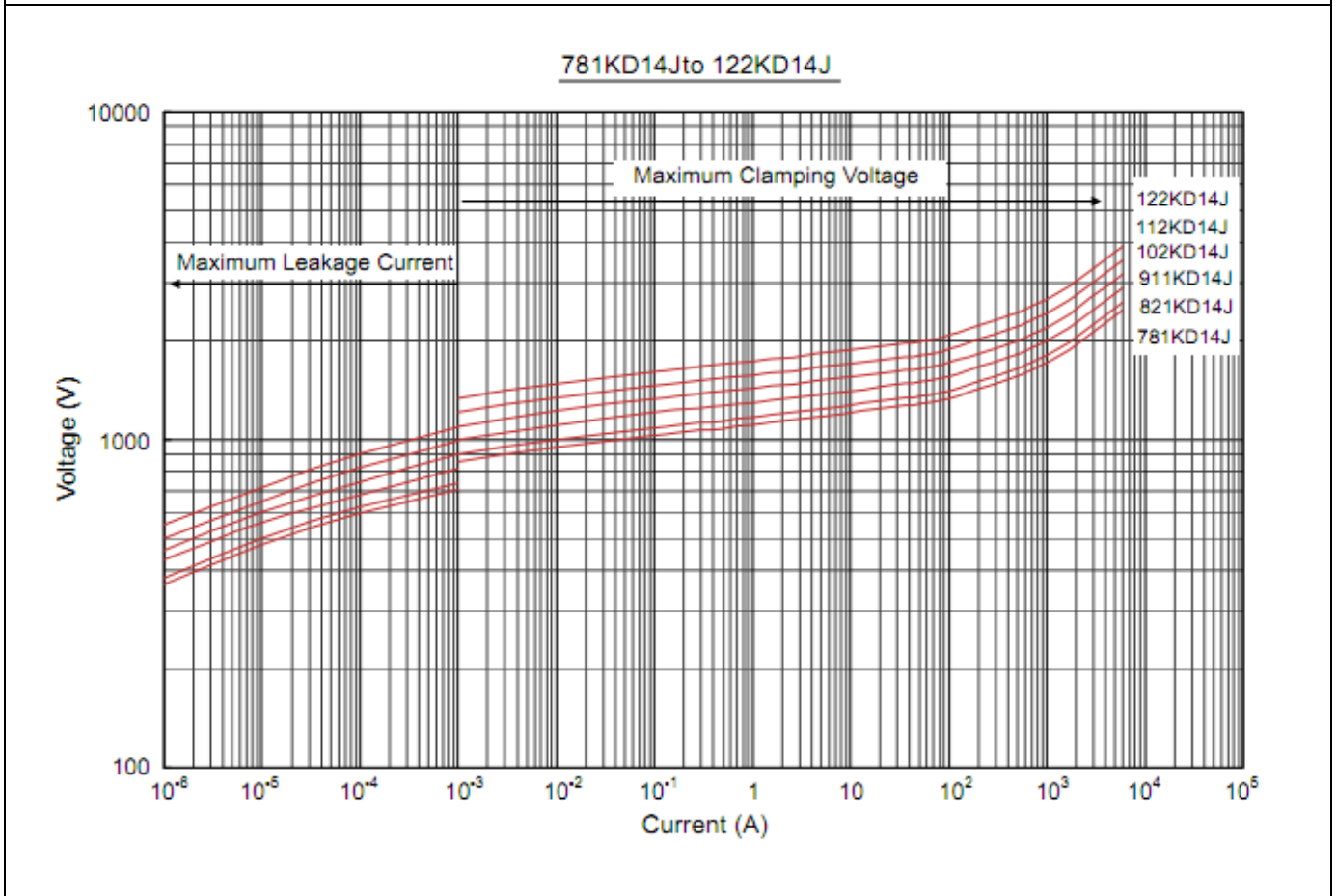
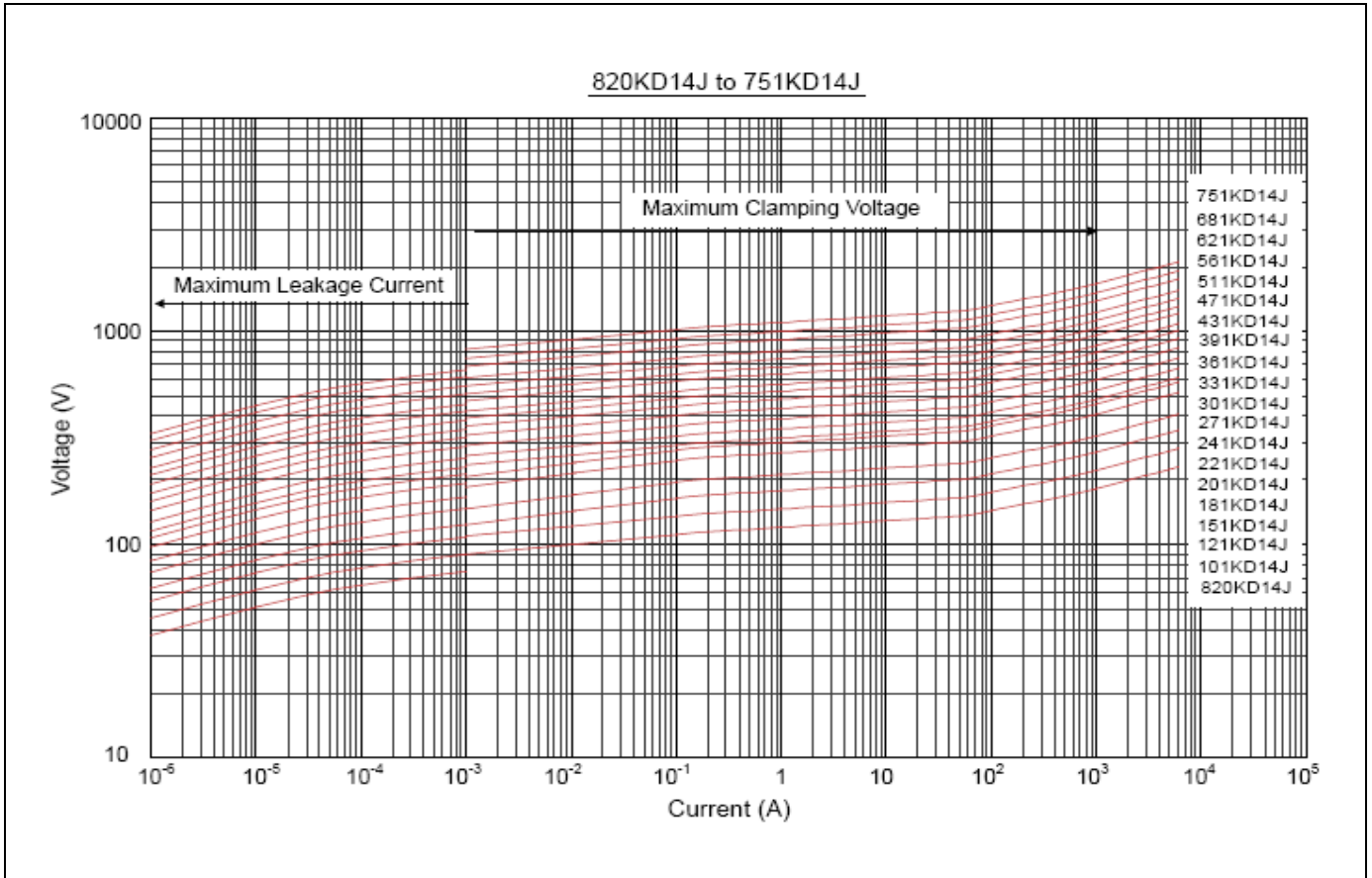

Reliability

Items	Standard	Test conditions / Methods	Specifications															
Tensile Strength of Terminals	IEC60068-2-21	Gradually applying the force specified and keeping the unit fixed for 10±1 sec. <table style="width: 100%; border-collapse: collapse;"> <tr> <td style="text-align: center; border-bottom: 1px solid black;">Terminal diameter (mm)</td> <td style="text-align: center; border-bottom: 1px solid black;">Force (kg)</td> </tr> <tr> <td style="text-align: center;">0.5 < d ≤ 0.8</td> <td style="text-align: center;">1.0</td> </tr> <tr> <td style="text-align: center;">0.8 < d ≤ 1.25</td> <td style="text-align: center;">2.0</td> </tr> <tr> <td style="text-align: center;">1.25 < d</td> <td style="text-align: center;">4.0</td> </tr> </table>	Terminal diameter (mm)	Force (kg)	0.5 < d ≤ 0.8	1.0	0.8 < d ≤ 1.25	2.0	1.25 < d	4.0	No visible damage ΔV _{1mA} /V _{1mA} ≤ 5%							
Terminal diameter (mm)	Force (kg)																	
0.5 < d ≤ 0.8	1.0																	
0.8 < d ≤ 1.25	2.0																	
1.25 < d	4.0																	
Bending Strength of Terminals	IEC60068-2-21	Hold specimen and apply the force specified below to each lead. Bend the specimen to 90°, then return to the original position. Repeat the procedure in the opposite direction. <table style="width: 100%; border-collapse: collapse;"> <tr> <td style="text-align: center; border-bottom: 1px solid black;">Terminal diameter (mm)</td> <td style="text-align: center; border-bottom: 1px solid black;">Force (kg)</td> </tr> <tr> <td style="text-align: center;">0.5 < d ≤ 0.8</td> <td style="text-align: center;">0.5</td> </tr> <tr> <td style="text-align: center;">0.8 < d ≤ 1.25</td> <td style="text-align: center;">1.0</td> </tr> <tr> <td style="text-align: center;">1.25 < d</td> <td style="text-align: center;">2.0</td> </tr> </table>	Terminal diameter (mm)	Force (kg)	0.5 < d ≤ 0.8	0.5	0.8 < d ≤ 1.25	1.0	1.25 < d	2.0	No visible damage ΔV _{1mA} /V _{1mA} ≤ 5%							
Terminal diameter (mm)	Force (kg)																	
0.5 < d ≤ 0.8	0.5																	
0.8 < d ≤ 1.25	1.0																	
1.25 < d	2.0																	
Vibration	IEC60068-2-6	Frequency range: 10~55 Hz Amplitude: 0.75mm or 98m/s ² Direction: 3 mutually perpendicular directions, 2hrs each.	No visible damage ΔV _{1mA} /V _{1mA} ≤ 5%															
Solderability	IEC60068-2-20	Solder Temp: 245±5°C Dipping Time: 2±0.5 sec	At least 95% of terminal electrode is covered by new solder															
Resistance to Soldering Heat	IEC60068-2-20	Solder Temp: 260±5°C Dipping Time: 10±1 sec	No visible damage ΔV _{1mA} /V _{1mA} ≤ 5%															
High Temperature Storage	IEC60068-2-2	Ambient Temp: 125±2°C Duration: 1000±24hrs	No visible damage ΔV _{1mA} /V _{1mA} ≤ 5%															
Low Temperature Storage	IEC60068-2-1	Ambient Temp: -40±2°C Duration: 1000±24hrs	No visible damage ΔV _{1mA} /V _{1mA} ≤ 5%															
Damp Heat, Steady State	IEC60068-2-78	The test is divided into two groups . a. 40±2°C , 90~95% RH for 1344±24hrs b. 40±2°C , 90~95% RH, at 10%VDC , 1344±24 hrs	No visible damage ΔV _{1mA} /V _{1mA} ≤ 10% Insulation Resistance ≥ 100MΩ															
High Temperature Load	MIL-STD-202 Method 108	Ambient Temp: 105±2°C Duration: 1000±24hrs Load: Max. Allowable Voltage In AC.	ΔV _{1mA} /V _{1mA} ≤ 10%															
Temperature Cycle	IEC60068-2-14	The conditions shown below shall be repeated 5 cycles <table border="1" style="width: 100%; border-collapse: collapse; margin-top: 10px;"> <thead> <tr> <th>Step</th> <th>Temperature (°C)</th> <th>Period (minutes)</th> </tr> </thead> <tbody> <tr> <td style="text-align: center;">1</td> <td style="text-align: center;">-40±3</td> <td style="text-align: center;">30±3</td> </tr> <tr> <td style="text-align: center;">2</td> <td style="text-align: center;">Room temperature</td> <td style="text-align: center;">5±3</td> </tr> <tr> <td style="text-align: center;">3</td> <td style="text-align: center;">125±3</td> <td style="text-align: center;">30±3</td> </tr> <tr> <td style="text-align: center;">4</td> <td style="text-align: center;">Room temperature</td> <td style="text-align: center;">5±3</td> </tr> </tbody> </table>	Step	Temperature (°C)	Period (minutes)	1	-40±3	30±3	2	Room temperature	5±3	3	125±3	30±3	4	Room temperature	5±3	No visible damage ΔV _{1mA} /V _{1mA} ≤ 5%
Step	Temperature (°C)	Period (minutes)																
1	-40±3	30±3																
2	Room temperature	5±3																
3	125±3	30±3																
4	Room temperature	5±3																
8/20uS Surge Life	IEC61051-1	8/20μS waveform, 10 surge currents, unipolar, interval 30secs, amplitude corresponding to max. surge current derating curves for 20μS.	No visible damage ΔV _{b(1mA)} ≤ ±10%															
10/1000μS Surge Life	IEC61051-1	10/1000μS waveform, 10 surge currents, unipolar, interval 2mins, amplitude corresponding to max. surge current derating curves for 1000μS.	No visible damage ΔV _{1mA} /V _{1mA} ≤ 10%															
Voltage Proof	IEC61051-1	Metal balls method, 2500Vac 1 min.	No visible damage															

Soldering Recommendation

Lead-free Wave Soldering Recommendation

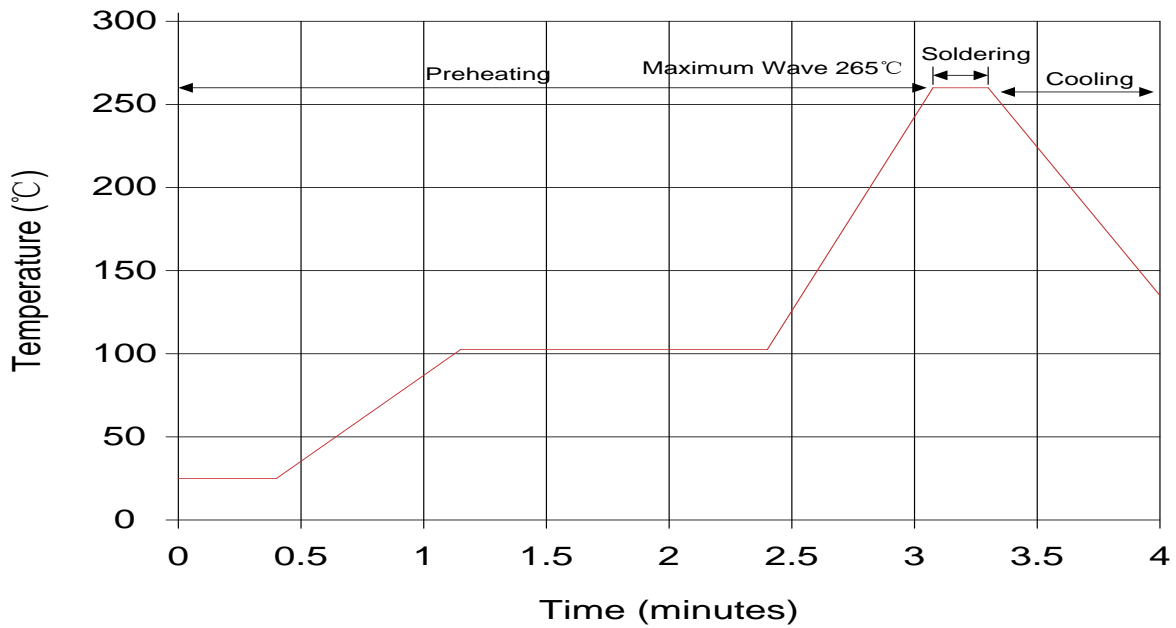

Item	Conditions
Peak Temperature	265°C
Dipping Time	10 seconds (max.)
Soldering	1 time

Recommendation Reworking Conditions with Soldering Iron

Item	Conditions
Temperature of Soldering Iron-tip	360°C (max.)
Soldering Time	3 seconds (max.)
Distance from Varistor	2mm (min.)

Marking Code

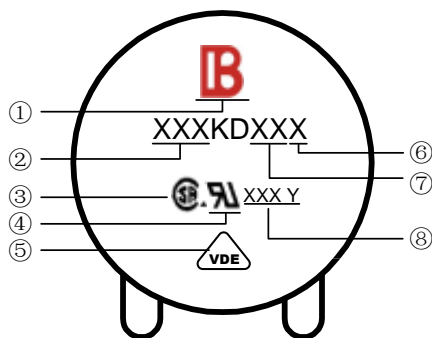

- ① Brightking Logo
- ② Varistor Voltage
- ③ CSA Accreditation Logo
- ④ UL Accreditation Logo
- ⑤ VDE Accreditation Logo
- ⑥ “J” is High Surge Code, no “J” is Standard Surge
- ⑦ Disk Size
- ⑧ Internal control code

Taping Dimensions

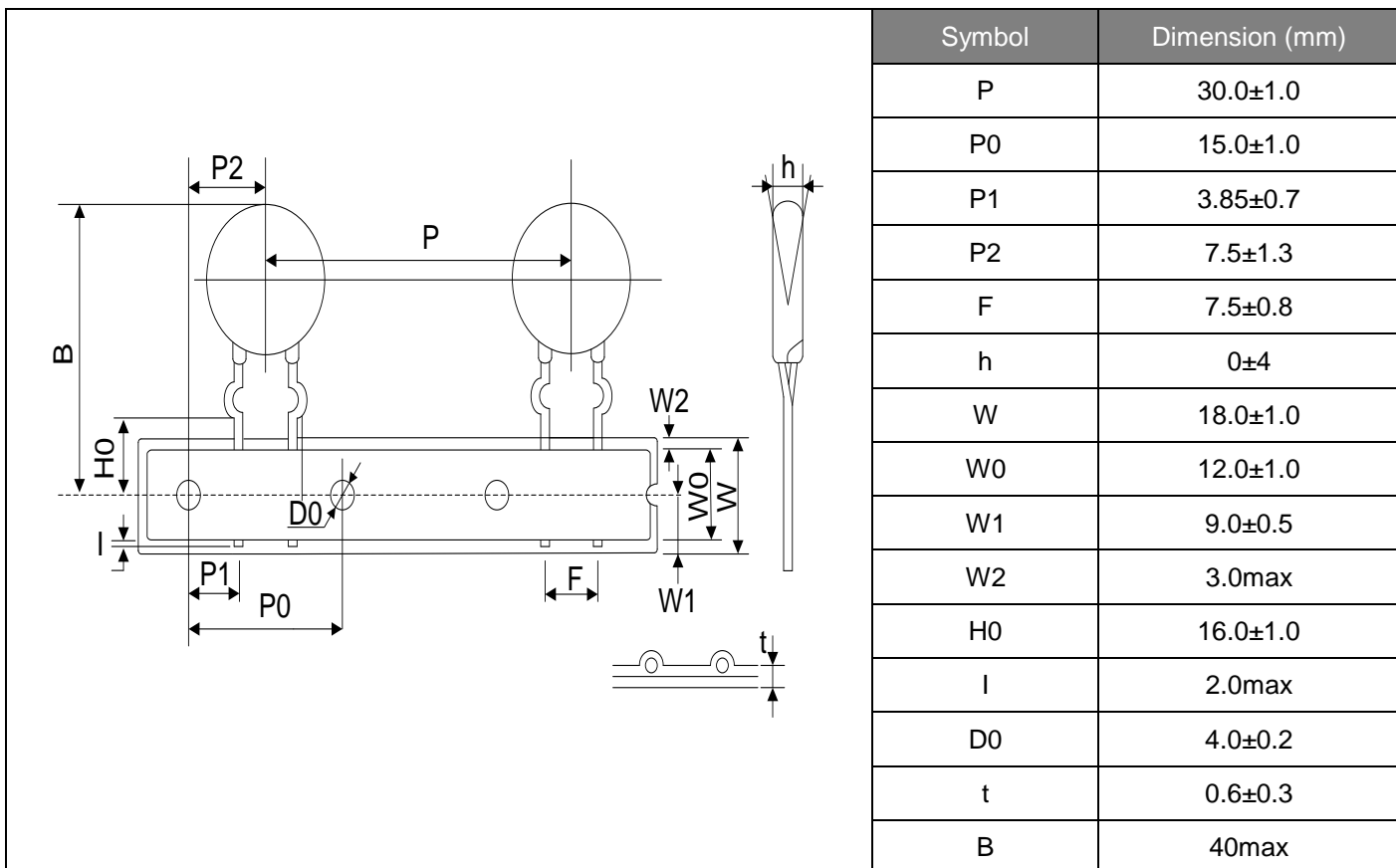
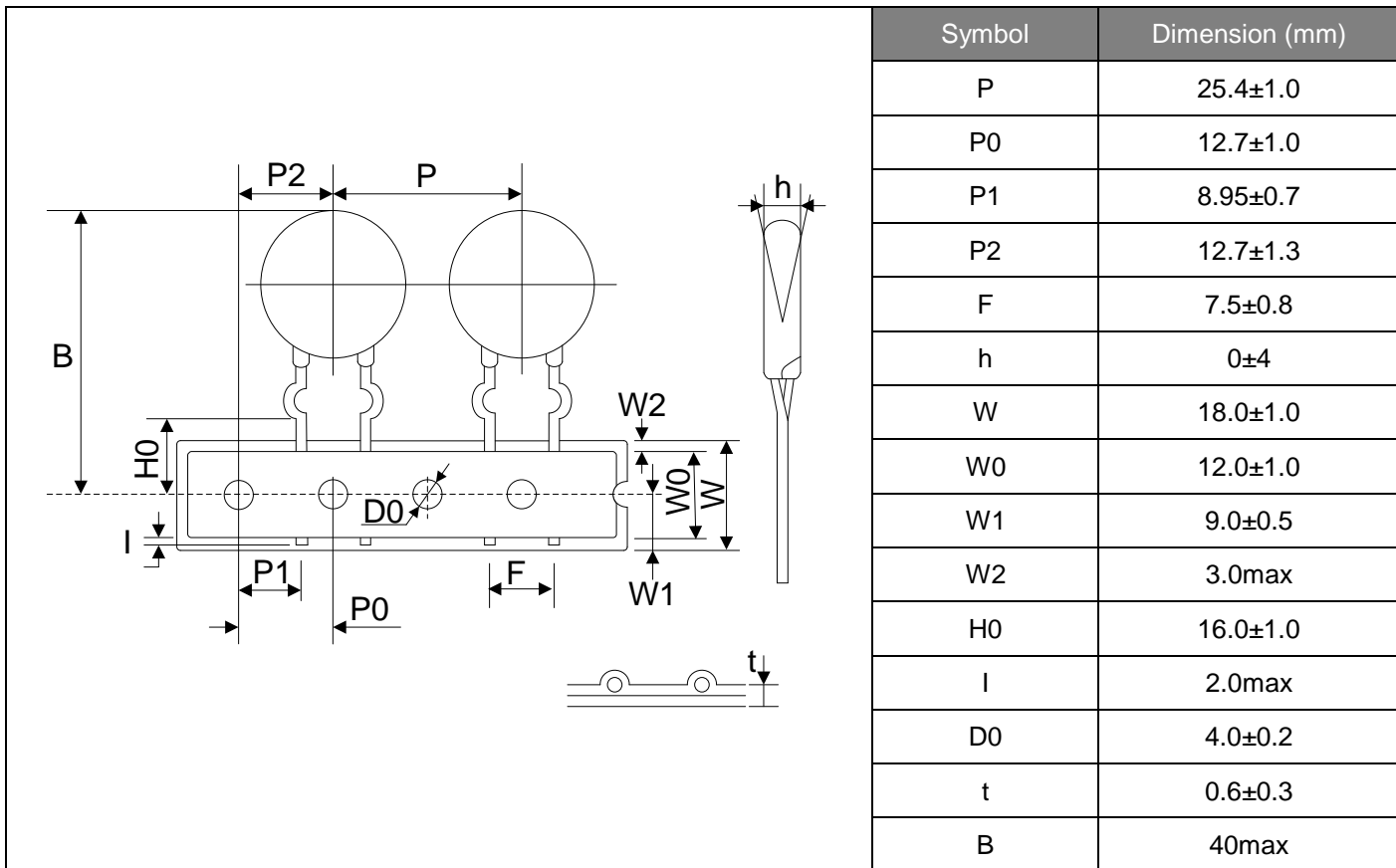

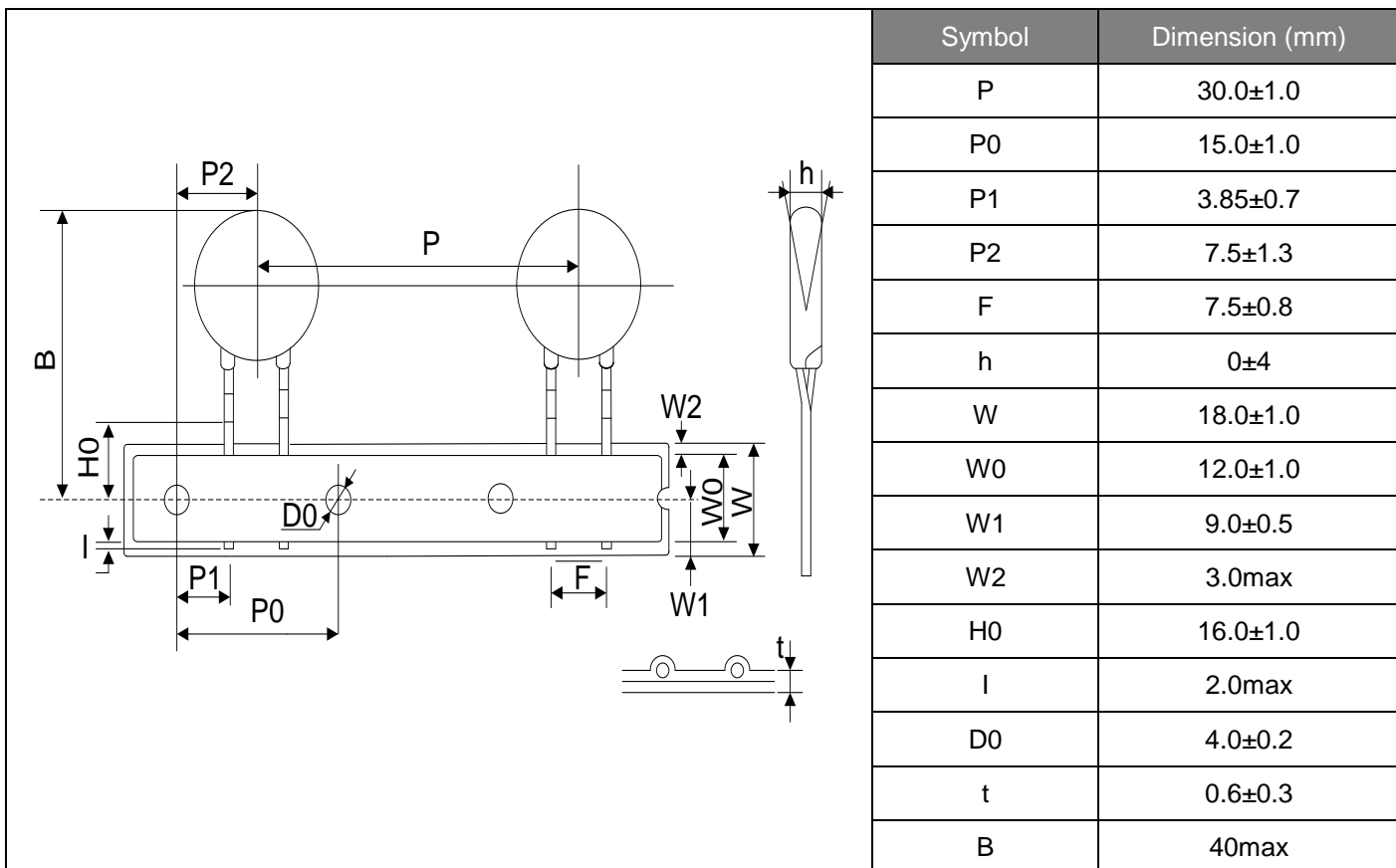
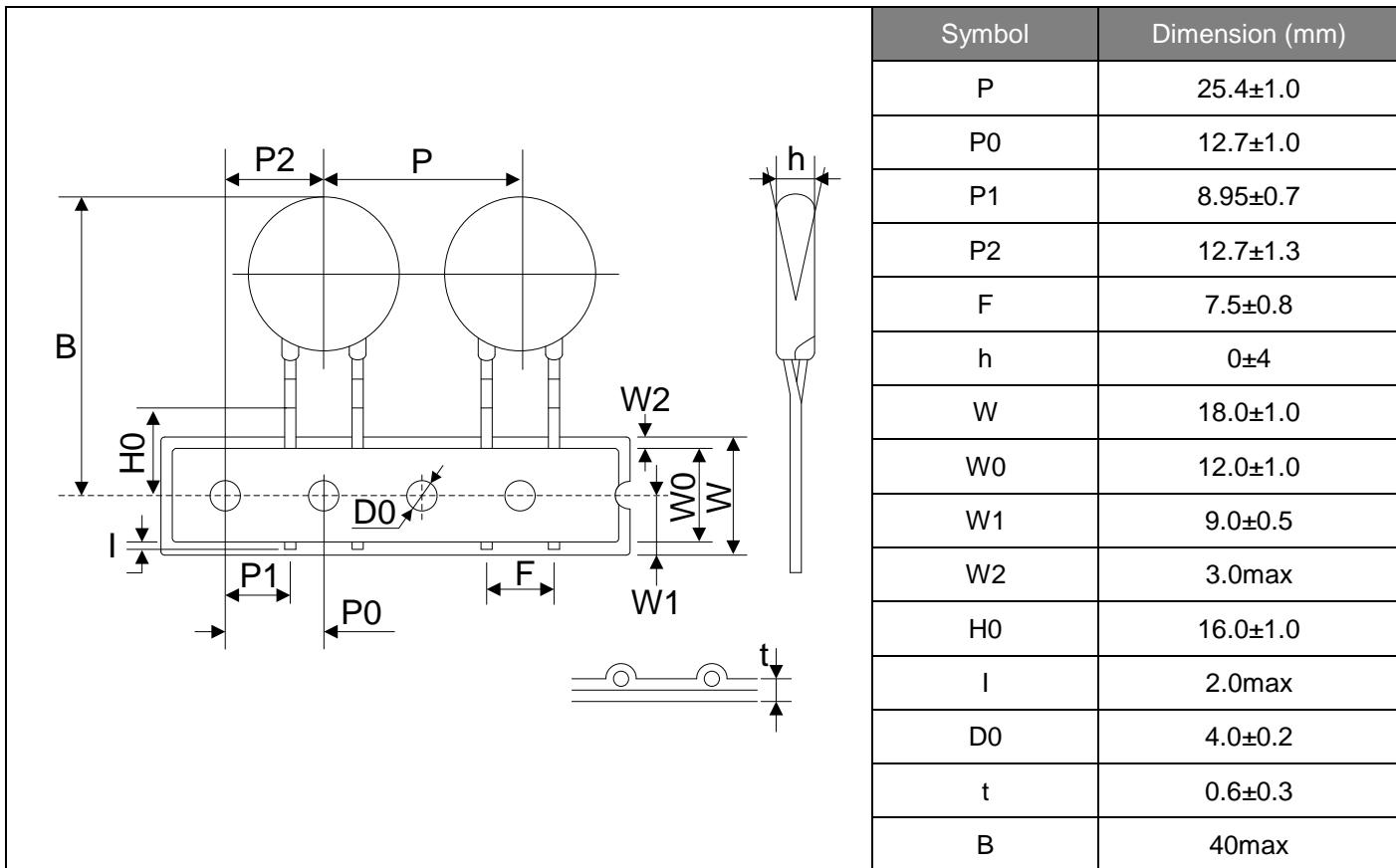

Taping Dimensions

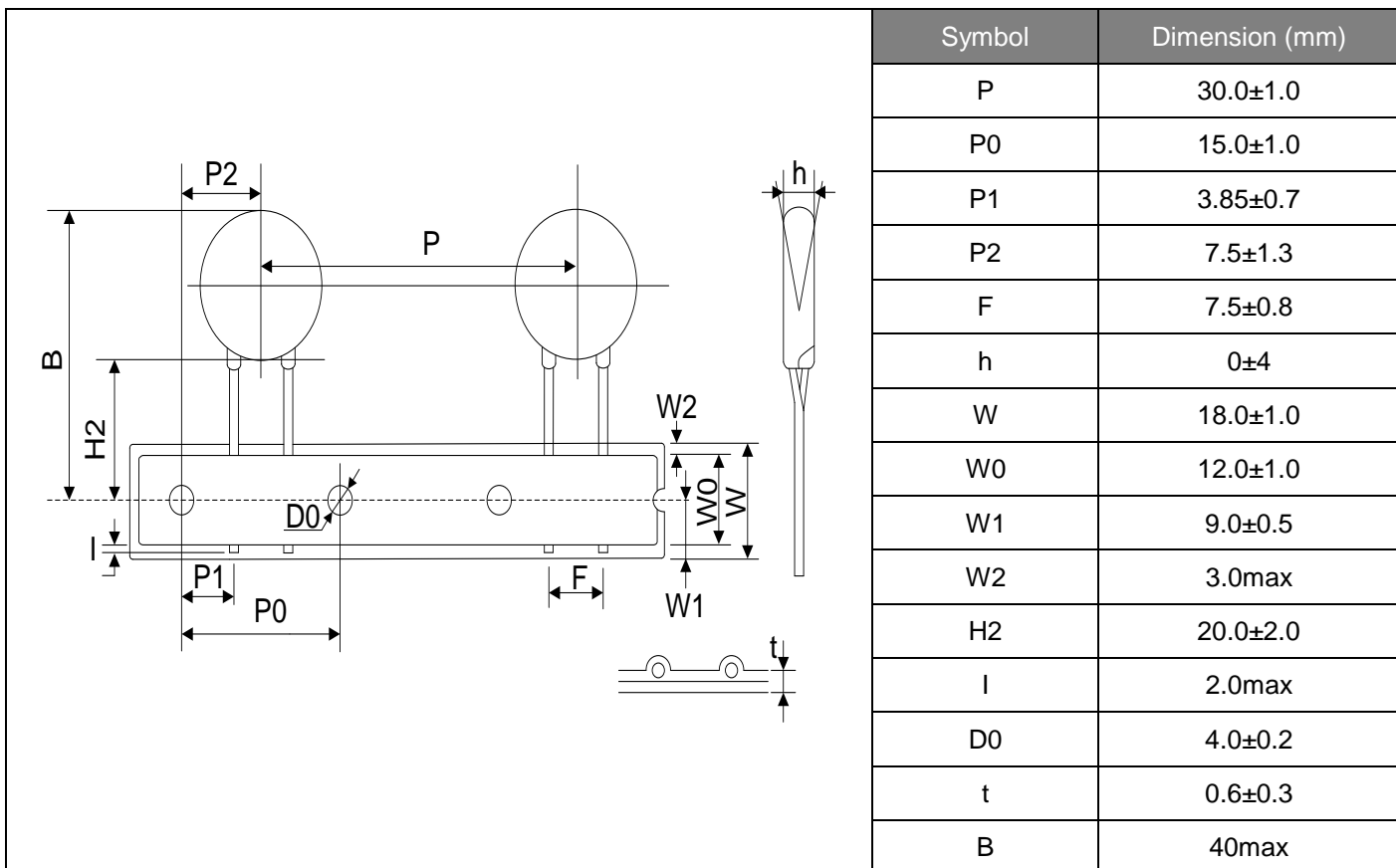
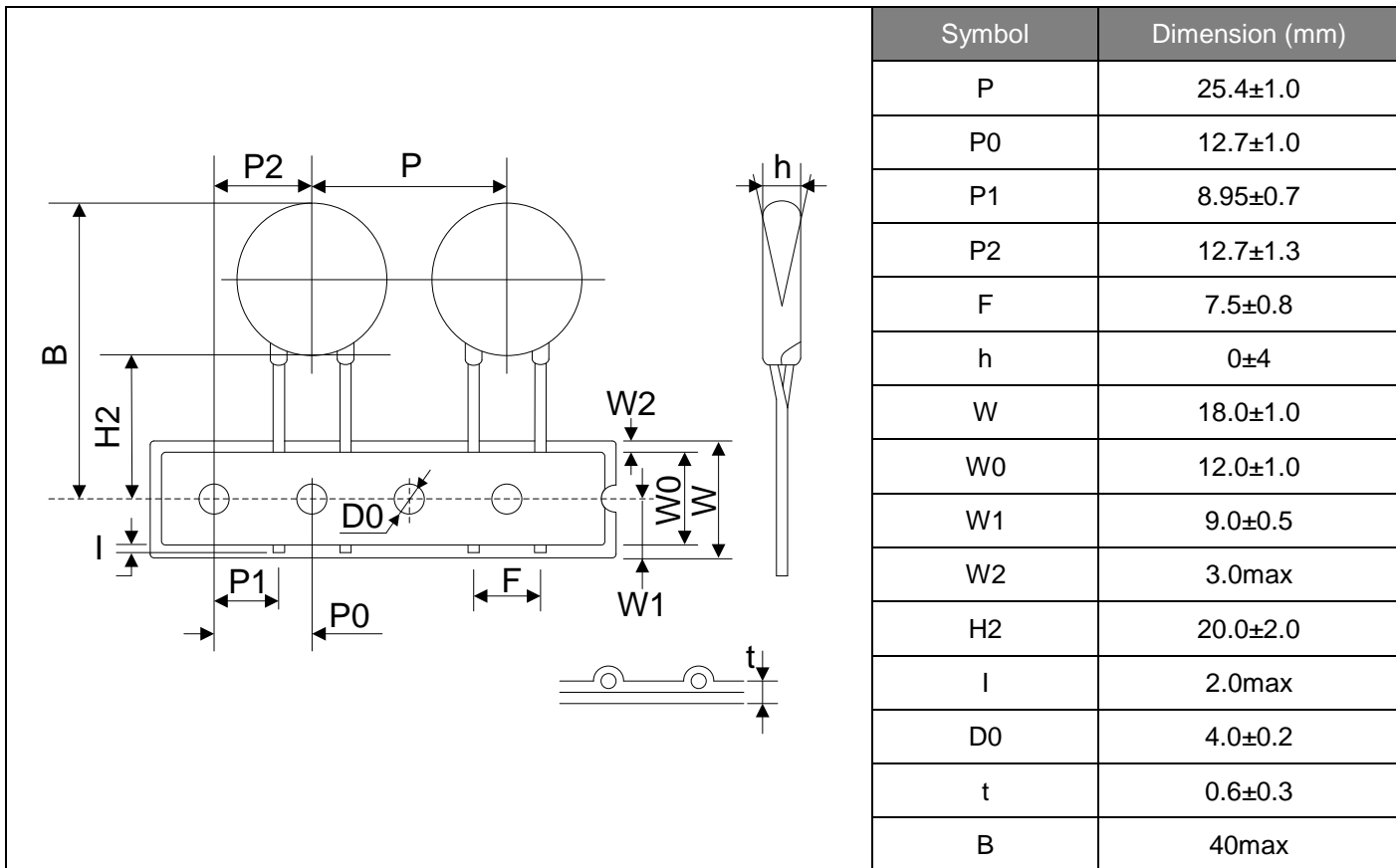

Taping Dimensions

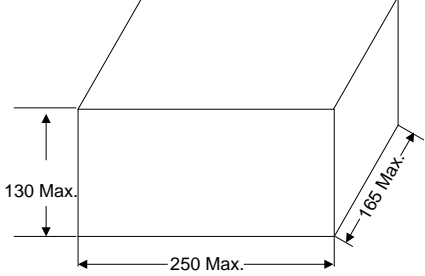

Quantity

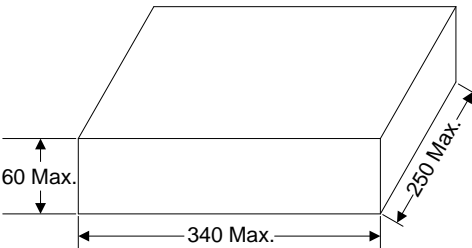
Packaging Dimensions (Unit: mm)	Quantity
<p>In bulk for Terminals Untrimmed Products</p> 	400pcs/bag 4bags/box (180K~331K)
	300pcs/bag 4bags/box (361K~621K)
	250pcs/bag 4bags/box (681K~112K)
	150pcs/bag 4bags/box (122K~182K)
<p>In bulk for Terminals Trimmed Products</p> 	400pcs/bag 4bags/box (180K~331K)
	300pcs/bag 4bags/box (361K~621K)
	250pcs/bag 4bags/box (681K~112K)
	150pcs/bag 4bags/box (122K~182K)
Packaging Dimensions (Unit: mm)	Quantity
<p>Tape & Box & P0=12.7mm</p> 	750pcs/ box (180K~241K)
	600pcs/ box (271K~331K)
	500pcs/ box (361K~621K)
	400pcs/ box (681K~751K)
	350pcs/ box (781K~112K)

Quantity

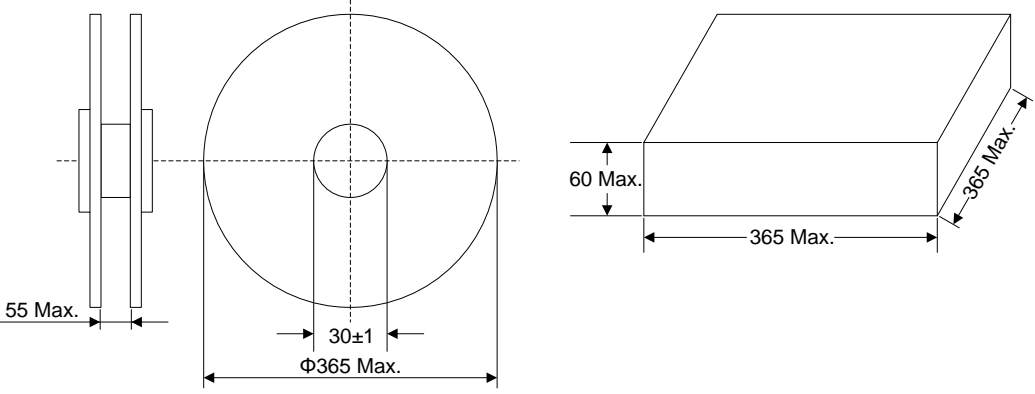
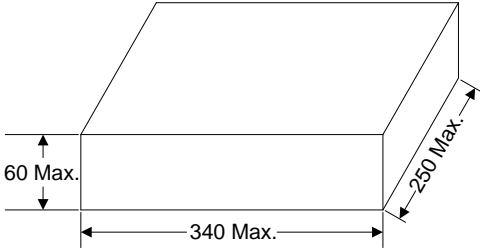
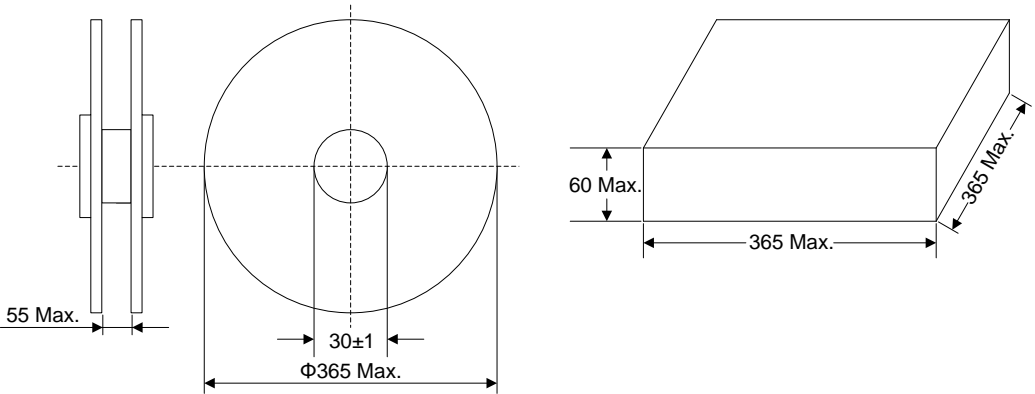
Packaging Dimensions (Unit: mm)	Quantity
<p>Tape & Reel & P0=12.7mm</p> 	<p>1000pcs/reel (180K~331K)</p> <p>750pcs/reel (361K~621K)</p> <p>500pcs/reel (681K~751K)</p> <p>400pcs/reel (781K~112K)</p>
<p>Packaging Dimensions (Unit: mm)</p> <p>Tape & Box & P0=15.0mm</p> 	<p>Quantity</p> <p>500pcs/ box (180K~331K)</p> <p>400pcs/ box (361K~751K)</p> <p>300pcs/ box (781K~112K)</p>
<p>Tape & Reel & P0=15.0mm</p> 	<p>750pcs/reel (180K~331K)</p> <p>600pcs/reel (361K~751K)</p> <p>500pcs/reel (781K~112K)</p>

Storage Condition of Products

(I) Storage Conditions :

- 1.Storage Temperature : $-10^{\circ}\text{C} \sim +40^{\circ}\text{C}$
- 2.Relative Humidity : $\cong 80\%RH$
- 3.Keep away from corrosive atmosphere and sunlight.

(II) Period of Storage : 1 year