

Data sheet | Item number: 2061-1641/998-404

THR PCB terminal block; push-button; 1.5 mm²; Pin spacing 6 mm; 1-pole;
Push-in CAGE CLAMP®; in tape-and-reel packaging; 1,50 mm²; white

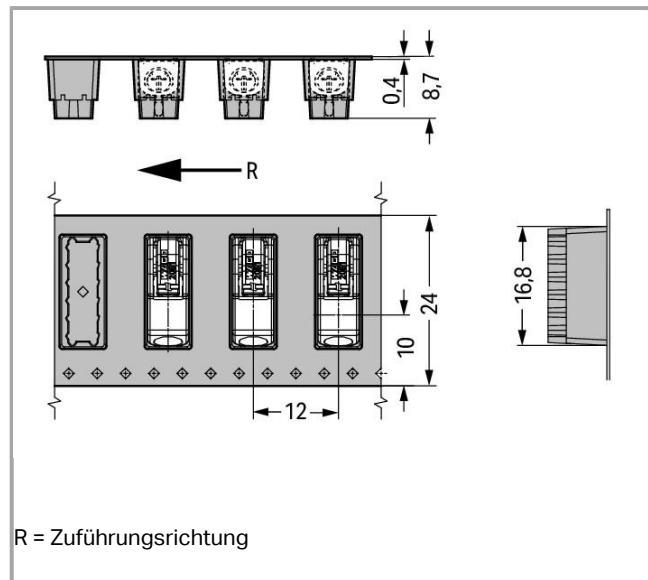

www.wago.com/2061-1641/998-404

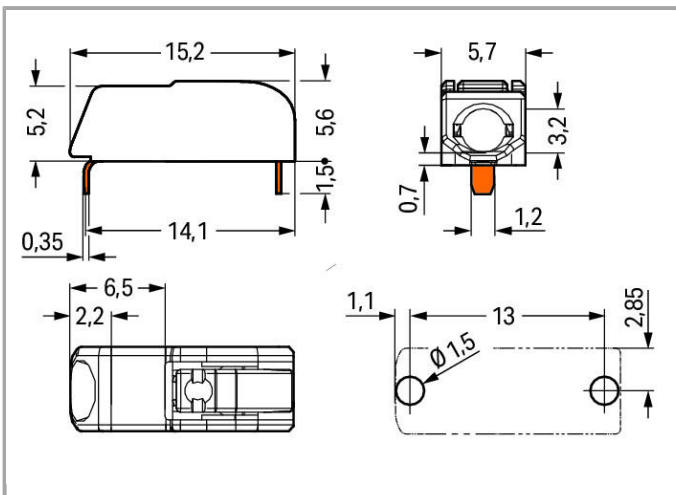
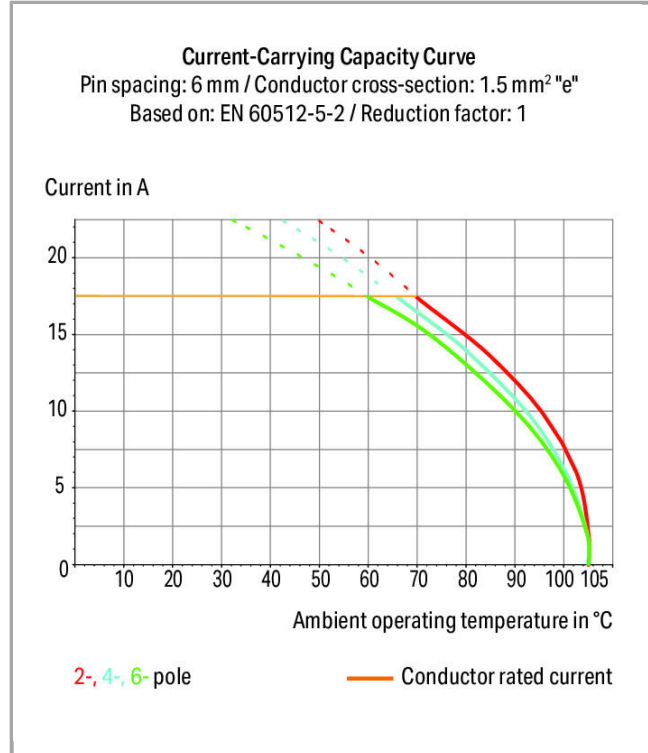
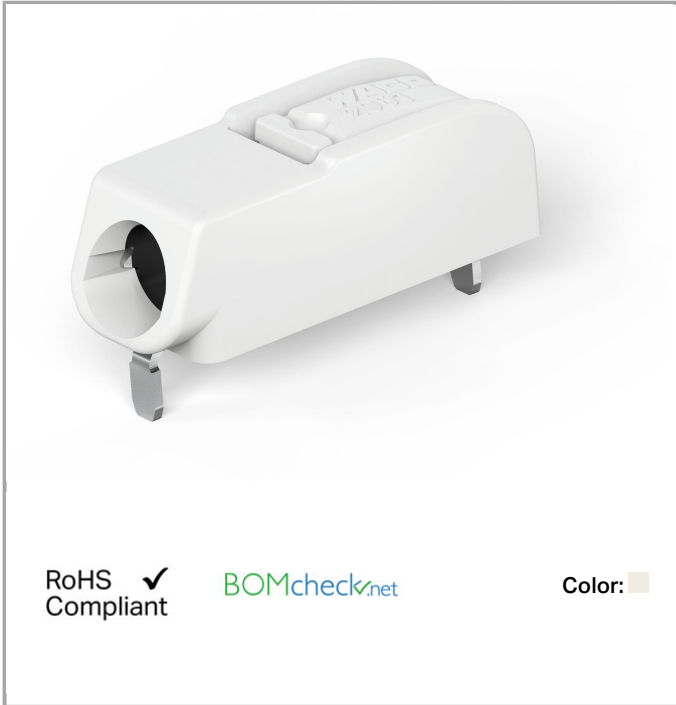



Item description

- THR PCB terminal blocks with push-buttons and Push-in CAGE CLAMP® connection
- Push-in termination of solid and ferruled conductors
- Push-buttons simplify insertion/removal of all conductor types
- Just 5.6 mm tall
- Available in tape-and-reel packaging for automated assembly
- Also suitable for wave soldering
- Assemble terminal blocks without pole loss

Note:

Application note:

Suitable for lead-free, reflow-soldering profiles per DIN EN 61760-1 and IEC 60068-2-58 up to max. 260 °C peak temperature. Due to customer-specific variables (e.g., component configuration and orientation, type of soldering machine, solder paste), trial runs are recommended to ensure product and process compatibility under actual manufacturing conditions.

Recommendation:

Recommendation for stencil:

150 µm material thickness

The stencil hole diameter is identical to the outer diameter of the metal-plated PCB hole.

Data

Electrical data

Ratings per IEC/EN 60664-1

Rated voltage (III / 3)	250 V
Rated impulse voltage (III / 3)	4 kV
Rated voltage (III / 2)	320 V
Rated impulse voltage (III / 2)	4 kV
Rated voltage (II / 2)	630 V
Rated impulse voltage (II / 2)	4 kV
Rated current	17.5 A

Approvals per UL 1059

Rated voltage UL (Use Group B)	600 V
Rated current UL (Use Group B)	10 A
Rated voltage UL (Use Group D)	600 V
Rated current UL (Use Group D)	5 A

Connection data

Connection technology	Push-in CAGE CLAMP®
Actuation type	Push-button
Solid conductor	0.5 ... 1.5 mm ² / 20 ... 16 AWG
Fine-stranded conductor	0.5 ... 1.5 mm ² / 20 ... 16 AWG
Fine-stranded conductor with ferrule with plastic collar	0.5 ... 0.75 mm ²
Fine-stranded conductor with ferrule without plastic collar	0.5 ... 0.75 mm ²
Strip length	7 ... 10 mm / 0.28 ... 0.39 inch
Conductor entry angle to the PCB	0°
Total number of connection points	1
Total number of potentials	1
Number of connection types	1
Number of levels	1
No. of poles	1

Geometrical Data

Pin spacing	6 mm / 0.24 inch
Width	5.7 mm / 0.224 inch
Height	7.1 mm / 0.28 inch
Height from the surface	5.6 mm / 0.22 inch
Depth	15.2 mm / 0.598 inch
Solder pin length	1.5 mm
Solder pin dimensions	1.2 x 0.35 mm
Reel diameter of tape-and-reel packaging	330 mm
Tape width	24 mm

PCB contact

PCB contact	THR
Solder pin arrangement	within the terminal block, in line
Number of solder pins per potential	2

Material Data

Color	white
Material group	I
Insulating material	Polyphthalamide (PPA GF)
Flammability class per UL94	V0
Clamping spring material	Chrome nickel spring steel (CrNi)
Contact material	Copper alloy
Contact plating	tin-plated
Weight	0.524 g

Environmental Requirements



Limit temperature range	-60 ... +105 °C
-------------------------	-----------------

Commercial data

Country of origin	CH
GTIN	4055143274722
Customs Tariff No.	85369010000

Approvals / Certificates

Country specific Approvals

Logo	Approval	Additional Approval Text	Certificate name
	CCA DEKRA Certification B.V.	EN 60947-7-4	NTR NL-7459
	CCA DEKRA Certification B.V.	EN 60838	NTR NL-7721
	KEMA/KEUR DEKRA Certification B.V.	EN 60947-7-4	71-100855
	KEMA/KEUR DEKRA Certification B.V.	EN 60838	71-106232











UL-Approvals



Logo	Approval	Additional Approval Text	Certificate name
	cURus Underwriters Laboratories Inc.	UL 1059	E45172

Compatible products

ferrule

	Item no.: 216-101 Ferrule; Sleeve for 0.5 mm ² / AWG 22; uninsulated; electro-tin plated	www.wago.com/216-101
	Item no.: 216-102 Ferrule; Sleeve for 0.75 mm ² / AWG 20; uninsulated; electro-tin plated	www.wago.com/216-102
	Item no.: 216-141 Ferrule; Sleeve for 0.5 mm ² / 20 AWG; uninsulated; electro-tin plated; electrolytic copper; gastight crimped; acc. to DIN 46228, Part 1/08.92	www.wago.com/216-141
	Item no.: 216-142 Ferrule; Sleeve for 0.75 mm ² / 18 AWG; uninsulated; electro-tin plated; electrolytic copper; gastight crimped; acc. to DIN 46228, Part 1/08.92	www.wago.com/216-142
	Item no.: 216-201 Ferrule; Sleeve for 0.5 mm ² / 20 AWG; insulated; electro-tin plated; white	www.wago.com/216-201
	Item no.: 216-202 Ferrule; Sleeve for 0.75 mm ² / 18 AWG; insulated; electro-tin plated; gray	www.wago.com/216-202
	Item no.: 216-241 Ferrule; Sleeve for 0.5 mm ² / 20 AWG; insulated; electro-tin plated; electrolytic copper; gastight crimped; acc. to DIN 46228, Part 4/09.90; white	www.wago.com/216-241
	Item no.: 216-242 Ferrule; Sleeve for 0.75 mm ² / 18 AWG; insulated; electro-tin plated; electrolytic copper; gastight crimped; acc. to DIN 46228, Part 4/09.90; gray	www.wago.com/216-242
	Item no.: 216-262 Ferrule; Sleeve for 0.75 mm ² / 18 AWG; insulated; electro-tin plated; electrolytic copper; gastight crimped; acc. to DIN 46228, Part 4/09.90; gray	www.wago.com/216-262

tools

	Item no.: 2061-189 Operating tool; made of insulating material; for 2061 Series	www.wago.com/2061-189
	Item no.: 206-861 Operating tool; for 2061 Series	www.wago.com/206-861



Downloads

Documentation

Additional Information

Technical explanations	Apr 3, 2019	pdf 3.6 MB	Download
------------------------	-------------	---------------	----------

CAD/CAE-Data

CAD data

3D Download 2061-1641/998-404	URL	Download
-------------------------------	-----	----------

Subject to changes.